

Numerical Control (CNC)

PLC Development Manual

M800V/M80V Series

Introduction

This manual describes the PLC development environment of Mitsubishi Electric CNC.

■ Peripheral development environment

The descriptions regarding the user PLC development environment using the Mitsubishi Electric FA engineering software GX Works2, which is the PLC development tool for PLC MELSEC Series, focus on the usage specific to this CNC.

■ Built-in edit function (PLC On-board)

Operations related to the PLC carried out with the Mitsubishi Electric CNC unit are described.

Read this manual thoroughly and understand the product's functions and performance before use.

Supported models of this manual are as follows:

Supported models	Abbreviations in this manual
M800VW Series	M850VW, M830VW
M800VS Series	M850VS, M830VS
M80VW Series	M80VW
M80V Series	M80V TypeA, M80V TypeB

Abbreviations for model names used in this manual are as follows:

Abbreviations	Supported models
M800V, M800V Series	M800VW Series/M800VS Series
M80V, M80V Series	M80VW Series/M80V Series
M800V/M80V, M800V/M80V Series	M800VW Series/M800VS Series/M80VW Series/M80V Series
M8V, M8V Series	M800VW Series/M800VS Series/M80VW Series/M80V Series

To safely use this CNC unit, thoroughly study the "Precautions for Safety" before use.

Be sure to keep this manual on hand so that users can refer to it at any time.

Also refer to the manuals on "Manual List" as necessary.

For descriptions regarding the user PLC development environment using GX Developer, refer to the relevant manuals and specifications manuals on "Manual List".

■ Notes on reading this manual

- (1) The version numbers are current as of the editing of this manual, but may be updated in the future.
- (2) Refer to "PLC Interface Manual" for the various signal interfaces and functions of the CNC unit required when creating Mitsubishi Electric CNC sequence programs (built-in PLC).

■ Details described in this manual

- ◆ In this manual, the following abbreviations might be used.
 - L system: Lathe system
 - M system: Machining center system

Manual List

Manuals related to M800V/M80V Series are listed as follows.

These manuals are written on the assumption that all optional functions are added to the targeted model.

Some functions or screens may not be available depending on the machine or specifications set by MTB. (Confirm the specifications before use.)

The manuals issued by MTB take precedence over these manuals.

Manual	IB No.	Purpose and Contents
M800V/M80V Series Instruction Manual	IB-1501618	<ul style="list-style-type: none">♦ Operation guide for NC♦ Explanation for screen operation, etc.
M800V/M80V Series Programming Manual (Lathe System) (1/2)	IB-1501619	<ul style="list-style-type: none">♦ G code programming for lathe system♦ Basic functions, etc.
M800V/M80V Series Programming Manual (Lathe System) (2/2)	IB-1501620	<ul style="list-style-type: none">♦ G code programming for lathe system♦ Functions for multi-part system, high-accuracy function, etc.
M800V/M80V Series Programming Manual (Machining Center System) (1/2)	IB-1501621	<ul style="list-style-type: none">♦ G code programming for machining center system♦ Basic functions, etc.
M800V/M80V Series Programming Manual (Machining Center System) (2/2)	IB-1501622	<ul style="list-style-type: none">♦ G code programming for machining center system♦ Functions for multi-part system, high-accuracy function, etc.
M800V/M80V Series Alarm/Parameter Manual	IB-1501623	<ul style="list-style-type: none">♦ Alarms♦ Parameters

Manuals for MTBs (NC)

Manual	IB No.	Purpose and Contents
M800V/M80V Series Specifications Manual (Function)	IB-1501610	<ul style="list-style-type: none"> ♦ Model selection ♦ Outline of various functions
M800V/M80V Series Specifications Manual (Hardware)	IB-1501611	<ul style="list-style-type: none"> ♦ Model selection ♦ Specifications of hardware unit
M800VW/M80VW Series Connection and Setup Manual	IB-1501612	<ul style="list-style-type: none"> ♦ Detailed specifications of hardware unit ♦ Installation, connection, wiring, setup (startup/adjustment)
M800VS/M80V Series Connection and Setup Manual	IB-1501613	<ul style="list-style-type: none"> ♦ Detailed specifications of hardware unit ♦ Installation, connection, wiring, setup (startup/adjustment)
M800V/M80V Series PLC Development Manual	IB-1501614	<ul style="list-style-type: none"> ♦ Electrical design ♦ I/O relation (assignment, setting, connection), field network ♦ Development environment (PLC on-board, peripheral development environment), etc.
M800V/M80V Series PLC Programming Manual (1/2)	IB-1501667	<ul style="list-style-type: none"> ♦ Electrical design ♦ Sequence programming ♦ Explanation for instructions, functions, and parameters
M800V/M80V Series PLC Programming Manual (2/2)	IB-1501668	<ul style="list-style-type: none"> ♦ Electrical design ♦ Sequence programming ♦ Usage examples of instructions
M800V/M80V Series PLC Interface Manual	IB-1501616	<ul style="list-style-type: none"> ♦ Electrical design ♦ Interface signals between NC and PLC
M800V/M80V Series Maintenance Manual	IB-1501617	<ul style="list-style-type: none"> ♦ Cleaning and replacement for each unit ♦ Other items related to maintenance

Manuals for MTBs (drive section)

Manual	IB No.	Contents
MDS-E/EH Series Specifications Manual	IB-1501226	<ul style="list-style-type: none"> ♦ Specifications for power supply regeneration type
MDS-E/EH Series Instruction Manual	IB-1501229	<ul style="list-style-type: none"> ♦ Instruction for power supply regeneration type
MDS-EJ/EJH Series Specifications Manual	IB-1501232	<ul style="list-style-type: none"> ♦ Specifications for regenerative resistor type
MDS-EJ/EJH Series Instruction Manual	IB-1501235	<ul style="list-style-type: none"> ♦ Instruction for regenerative resistor type
MDS-EM/EMH Series Specifications Manual	IB-1501238	<ul style="list-style-type: none"> ♦ Specifications for multi-hybrid, power supply regeneration type
MDS-EM/EMH Series Instruction Manual	IB-1501241	<ul style="list-style-type: none"> ♦ Instruction for multi-hybrid, power supply regeneration type
DATA BOOK	IB-1501252	<ul style="list-style-type: none"> ♦ Specifications of servo drive unit, spindle drive unit, motor, etc.
MDS-EX-CVP Series Specifications and Instruction Manual	IB-1501587	<ul style="list-style-type: none"> ♦ Specifications and instruction for the power supply unit with large capacity

Manuals for MTBs (Others)

Manual	No.	Purpose and Contents
GOT2000 Series User's Manual (Hardware)	SH-081194ENG	♦ Outline of hardware such as part names, external dimensions, installation, wiring, maintenance, etc. of GOTs
GOT2000 Series User's Manual (Utility)	SH-081195ENG	♦ Outline of utilities such as screen display setting, operation method, etc. of GOTs
GOT2000 Series User's Manual (Monitor)	SH-081196ENG	♦ Outline of each monitor function of GOTs
GOT2000 Series Connection Manual (Mitsubishi Electric Products)	SH-081197ENG	♦ Outline of connection types and connection method between GOT and Mitsubishi Electric connection devices
GT Designer3 (GOT2000) Screen Design Manual	SH-081220ENG	♦ Outline of screen design method using screen creation software GT Designer3
GOT2000/GOT1000 Series CC-Link Communication Unit User's Manual	IB-0800351	♦ Explanation for handling CC-Link communication unit (for GOT2000 series/GOT1000 series)
GX Developer Version 8 Operating Manual (Startup)	SH-080372E	♦ Explanation for system configuration, installation, etc. of PLC development tool GX Developer
GX Developer Version 8 Operating Manual	SH-080373E	♦ Explanation for operations using PLC development tool GX Developer
GX Converter Version 1 Operating Manual	IB-0800004	♦ Explanation for operations using data conversion tool GX Converter
GX Works2 Installation Instructions	BCN-P5999-0944	♦ Explanation for the operating environment and installation method of GX Works2
GX Works2 Version 1 Operating Manual (Common)	SH-080779ENG	♦ Explanation for the system configuration of GX Works2 and the functions common to Simple project and Structured project such as parameter setting, operation method for the online function
GX Works2 Version 1 Operating Manual (Simple Project)	SH-080780ENG	♦ Explanation for methods for such as creating and monitoring programs in Simple project of GX Works2
MELSEC-Q/L/F Structured Programming Manual (Fundamentals)	SH-080782ENG	♦ Explanation for programming methods, types of programming languages, etc. required to create structured programs
MELSEC-Q/L Structured Programming Manual (Application Functions)	SH-080784ENG	♦ Explanation for specifications and functions related to application functions which can be used in structured programs
GX Works2 Version 1 Operating Manual (Simple Project, Function Block)	SH-080984ENG	♦ Explanation for methods for such as creating function blocks, pasting function blocks to sequence programs, and operating FB library in Simple project of GX Works2
GX Works2 Version 1 Operating Manual (Structured Project)	SH-080781ENG	♦ Explanation for methods for such as creating and monitoring programs in Structured project of GX Works2
GX Works3 Installation Instructions	BCN-P5999-0391	♦ Explanation for the operating environment and installation method of GX Works3
MELSEC-Q CC-Link System Master/Local Module User's Manual	SH-080394E	♦ Explanation for system configuration, installation, wiring, etc. of master/local modules for CC-Link system
GOT2000 Series Connection Manual (Non-Mitsubishi Electric Products 1)	SH-081198ENG	♦ Explanation for connection types and connection method between GOT and other company's devices
GOT2000 Series Connection Manual (Non-Mitsubishi Electric Products 2)	SH-081199ENG	
GOT2000 Series Connection Manual (Microcomputers, MODBUS/Fieldbus Products, Peripherals)	SH-081200ENG	♦ Explanation for connection types and connection method between GOT and microcomputers, MODBUS/fieldbus products, peripherals
GT SoftGOT2000 Version1 Operating Manual	SH-081201ENG	♦ Explanation for system configuration, screen configuration and operation method of monitoring software GT SoftGOT2000
MELSEC iQ-R Programming Manual (CPU Module Instructions, Standard Functions/Function Blocks)	SH-081266ENG	♦ Explanation for instructions, general-purpose functions, and general-purpose function blocks required for programming the sequencer MELSEC iQ-R series



Reference Manual for MTBs

Manual	No.	Purpose and Contents
M800/M80 Series Smart safety observation Specification manual	BNP-C3072-022	♦ Explanation for smart safety observation function
M800/M80 Series CC-Link (Master/Local) Specification manual	BNP-C3072-089	♦ Explanation for CC-Link
M800/M80 Series PROFIBUS-DP Specification manual	BNP-C3072-118	♦ Explanation for PROFIBUS-DP communication function
M800/M80 Series Interactive cycle insertion (Customization) Specification manual	BNP-C3072-121-0003	♦ Explanation for interactive cycle insertion
M800/M80 Series EtherNet/IP Specifications manual	BNP-C3072-263	♦ Explanation for EtherNet/IP
M800/M80 Series CC-Link IE Field (Master/local) Specifications manual	BNP-C3072-283	♦ Explanation for CC-Link IE Field
M800/M80 Series GOT Connection Specifications manual	BNP-C3072-314	♦ Explanation for GOT connection
M800/M80 Series CC-Link IE Field Basic Specifications manual	BNP-C3072-337	♦ Explanation for CC-Link IE Field Basic
M800/M80 Series FL-net Specifications manual	BNP-C3072-368	♦ Explanation for FL-net
M800/M80 Series Synchronous Control Specifications manual	BNP-C3072-074	♦ Explanation for synchronous control
M800/M80 Series Multiple-Axis Synchronization Control Specifications manual	BNP-C3072-339	♦ Explanation for multiple-axis synchronization control

Precautions for Safety



Always read the specifications issued by the machine tool builder, this manual, related manuals and attached documents before installation, operation, programming, maintenance or inspection to ensure correct use. Understand this numerical controller, safety items and cautions before using the unit.



This manual ranks the safety precautions into "DANGER", "WARNING" and "CAUTION".

<p> DANGER</p> <p>When the user may be subject to imminent fatalities or major injuries if handling is mistaken.</p>
<p> WARNING</p> <p>When the user may be subject to fatalities or major injuries if handling is mistaken.</p>
<p> CAUTION</p> <p>When the user may be subject to medium or minor injuries or when only property damage may occur, if handling is mistaken.</p>











Note that even items ranked as "  CAUTION" may lead to serious consequences depending on the situation. All the items are important and must always be observed.

The following signs indicate prohibition and compulsory.

	<p>This sign indicates prohibited behavior (must not do).</p> <p>For example,  indicates "Keep fire away".</p>
---	--

	<p>This sign indicated a thing that is pompously (must do).</p> <p>For example,  indicates "it must be grounded".</p>
---	---

The meaning of each pictorial sign is as follows.

 CAUTION	 CAUTION rotated object	 CAUTION HOT	 Danger Electric shock risk	 Danger explosive
 Prohibited	 Disassembly is prohibited	 KEEP FIRE AWAY	 General instruction	 Earth ground

For Safe Use

Mitsubishi CNC is designed and manufactured solely for applications to machine tools to be used for industrial purposes. Do not use this product in any applications other than those specified above, especially those which are substantially influential on the public interest or which are expected to have significant influence on human lives or properties.

DANGER







Not applicable in this manual.

WARNING

Not applicable in this manual.

CAUTION

■ Items related to product and manual





-  For items described as "Restrictions" or "Usable State" in this manual, the instruction manual issued by the machine tool builder takes precedence over this manual.
-  The operations to which no reference is made in this manual should be considered "impossible".
-  This manual is written on the assumption that all the applicable functions are included. Some of them, however, may not be available for your NC system. Refer to the specifications issued by the machine tool builder before use.
-  For information about each machine tool, refer to manuals issued from the machine tool builder.
-  Some screens and functions may differ depending on each NC system (or version), and some functions may not be possible. Please confirm the specifications before starting to use.
-  To protect the availability, integrity and confidentiality of the NC system against cyber-attacks including unauthorized access, denial-of-service (DoS) (*1) attack, and computer virus from external sources via a network, take security measures such as firewall, VPN, and anti-virus software.
-  Mitsubishi Electric assumes no responsibility for any problems caused to the NC system by any type of cyber-attacks including DoS attack, unauthorized access and computer virus.

(*1) Denial-of-service (DoS) refers to a type of cyber-attack that disrupts services by overloading the system or by exploiting a vulnerability of the system.

■ Items related to start up and maintenance

-  Read this manual carefully and confirm the safety enough before executing the operation of the program change, forced output, RUN, STOP, etc. during operation. Operation mistakes may cause damage of the machine and accidents.

■ Items related to program development

-  Always observe the cautions before development to develop a program.
-  If the data transferred does not follow the file name rule, unexpected operations will occur. E.g. PLC program erasure
-  Do not read a sequence program on which a conversion error occurred into the GX Developer/GX Works2. The file may include unexpected contents to result an illegal operation.
-  When an error occurred at GX Developer/GX Works2 on-line function, the error message may not explain exactly the state in the CNC side. Always refer to the error list.

Disposal



(Note) This symbol mark is for EU countries only.

This symbol mark is according to the directive 2006/66/EC Article 20 Information for end-users and Annex II.

Your MITSUBISHI ELECTRIC product is designed and manufactured with high quality materials and components which can be recycled and/or reused.

This symbol means that batteries and accumulators, at their end-of-life, should be disposed of separately from your household waste.

If a chemical symbol is printed beneath the symbol shown above, this chemical symbol means that the battery or accumulator contains a heavy metal at a certain concentration. This will be indicated as follows:

Hg: mercury (0,0005%), Cd: cadmium (0,002%), Pb: lead (0,004%)

In the European Union there are separate collection systems for used batteries and accumulators.

Please, dispose of batteries and accumulators correctly at your local community waste collection/recycling centre.

Please, help us to conserve the environment we live in!

Trademarks

MELDAS, MELSEC, EZSocket, EZMotion, iQ Platform, MELSEC iQ-R, MELSOFT, GOT, CC-Link, CC-Link/LT, CC-Link IE, CC-Link IE/field, EcoMonitorLight and SLMP are either trademarks or registered trademarks of Mitsubishi Electric Corporation in Japan and/or other countries.

Ethernet is a registered trademark of Xerox Corporation in the United States and/or other countries.

Microsoft®, Windows®, SQL Server® and Access® are either trademarks or registered trademarks of Microsoft Corporation in the United States and/or other countries.

SD logo and SDHC logo are either registered trademarks or trademarks of LLC.

UNIX is a registered trademark of The Open Group in the United States and/or other countries.

Intel® and Pentium® are either trademarks or registered trademarks of Intel Corporation in the United States and/or other countries.

MODBUS® is either a trademark or a registered trademark of Schneider Electric USA, Inc. or the affiliated companies in Japan and/or other countries.

EtherNet/IP is a trademark of Open DeviceNet Vendor Association, Inc.

PROFIBUS-DP and PROFINET are either trademarks of Profibus International.

Oracle® is a registered trademark of Oracle Corporation, the subsidiaries, or the affiliated companies in the United States and /or other countries.

VNC is a registered trademark of RealVNC Ltd. in the United States and other countries.

QR Code is a registered trademark of DENSO WAVE INCORPORATED.

McAfee is a registered trademark or a trademark of McAfee, LLC or its subsidiaries in the United States and other countries.

Punchtap is licensed by EMUGE.

Other company and product names that appear in this manual are trademarks or registered trademarks of the respective companies.

本製品の取扱いについて

(日本語 /Japanese)

本製品は工業用(クラス A)電磁環境適合機器です。販売者あるいは使用者はこの点に注意し、住商業環境以外での使用をお願いいたします。

Handling of our product

(English)

This is a class A product. In a domestic environment this product may cause radio interference in which case the user may be required to take adequate measures.

본 제품의 취급에 대해서

(한국어 /Korean)

이 기기는 업무용(A 급) 전자파적합기기로서 판매자 또는 사용자는 이 점을 주의하시기 바라며 가정외의 지역에서 사용하는 것을 목적으로 합니다.

Contents

1 Definitions of Terms	1
2 System Configuration of H/W	3
2.1 System Configuration.....	4
2.2 Relation of RIO Unit and Devices	6
2.2.1 Outline of the Remote I/O Unit	6
2.2.2 PLC Device Assignment of Digital Signal (DI/DO)	8
2.2.2.1 Fixed Device Assignment	9
2.2.2.2 Arbitrary Device Assignment	10
2.2.3 Relation of Connector Pins and Device.....	14
2.2.4 Setting Example When Connecting Directly to the Control Unit.....	16
2.3 Fixed Signals.....	17
2.3.1 Ignoring Fixed Signals	17
2.3.2 Changing the Addresses of Fixed Signals	18
2.4 PLC I/F Axis Random Device Assignment.....	19
2.4.1 Function Enabling Conditions.....	20
2.4.2 Random Assignment of Bit-type Device	20
2.4.3 Example Usage	21
2.5 Outline of Digital Signal Input Circuit.....	22
2.6 Outline of Digital Signal Output Circuit.....	23
2.7 Outline of Analog Signal Input Circuit	25
2.8 Outline of Analog Signal Output Circuit.....	26
2.9 Outline of I/O Assignment with PROFIBUS-DP	27
2.10 Flow of Signals.....	28
2.11 List of Devices	29
2.11.1 Device Range Setting at Multi-project	30
2.12 File Register General Map	32
3 Input/Output Signals with Machine	35
3.1 Machine Input Signals.....	37
3.1.1 Input Signals from Machine.....	37
3.1.2 PLC Switch/Sensor	41
3.2 Machine Output Signals.....	43
3.2.1 Output Signals to Machine	43
3.2.2 PLC Switch.....	47
4 System Configuration of Development Environment.....	51
4.1 System Configuration for PLC Development	52
4.2 User PLC (Ladder) Development Procedure	53
5 Peripheral Development Environment (GX Works2)	55
5.1 Outline.....	56
5.1.1 Software Configuration	56
5.1.2 Operating Environment	57
5.2 Types of GX Works2 Projects and Programs Used for Mitsubishi Electric CNC	58
5.2.1 Support Status of Project Types, Program Types and POU's	58
5.3 GX Works2 Functions Available for Mitsubishi Electric CNC.....	60
5.3.1 Function Support Status (Common Functions)	61
5.3.2 Function Support Status (Label Setting)	65
5.3.3 Function Support Status (Device Comments)	65
5.3.4 Function Support Status (Ladder Diagram).....	66
5.3.5 Function Support Status (ST Language).....	68
5.3.6 Function Support Status (Online)	69
5.3.7 Function Support Status (NC Special Functions).....	71
5.4 Preparation.....	72
5.4.1 Installing Tools	72
5.4.2 Preparing Ethernet Communication	72
5.4.2.1 Checking IP address of CNC unit.....	72
5.4.2.2 Checking CNC unit setting prohibiting connection from GX Developer/GX Works2	72
5.4.2.3 Setting IP Address of Personal Computer	72
5.4.2.4 Connecting the Ethernet Cable.....	72
5.4.2.5 Setting Connection Destination	73

5.5 Common Items	76
5.5.1 Cautions Before Development	76
5.5.2 Multi-project Function	77
5.5.2.1 Setting Multi-project	77
5.5.2.2 Switching Projects to Access	78
5.5.3 PLC Data Storage Area	80
5.5.3.1 Executing Sequence Program	81
5.5.3.2 Relationship between Areas in CNC and Storage Areas Selectable on GX Works2	81
5.5.3.3 Displaying Storage Area on GX Works2	82
5.5.4 File Name	83
5.5.4.1 Naming Conventions for Sequence Programs, Parameters, and Device Comment Files	83
5.5.4.2 File Name Rule for Message Data	84
5.5.5 Creating Project	86
5.5.5.1 Project	86
5.5.5.2 Operating Procedures	87
5.5.6 Writing Data to CNC Controller	88
5.5.7 Reading Data from CNC Controller	89
5.5.8 Setting the Parameters	90
5.5.8.1 Parameter Setting Screen	90
5.5.8.2 Setting the Number of Device Points	91
5.5.8.3 Setting the Number of Common Pointer Points	93
5.5.8.4 Setting the Program Execution Order	94
5.5.8.5 Setting Labels and Comments to Each Project	95
5.5.8.6 Writing and Reading Parameters to CNC Controller	96
5.5.9 Starting/Stopping PLC	97
5.5.9.1 Operation Procedure	97
5.5.10 Reading Sequence Programs in GX Developer Format	98
5.5.10.1 Reading Sequence Programs in GX Developer Format on GX Works2	98
5.5.11 Sampling Trace of Device	100
5.5.11.1 Basic Operation	102
5.5.11.2 Basic Specifications	103
5.5.11.3 Status of Special Relay during Sampling Trace	106
5.5.11.4 Sampling Trace Operating Procedure	107
5.5.11.5 Operation on Error	114
5.5.11.6 Operation Example	115
5.5.11.7 Precautions	117
5.5.12 Checking Data Size	120
5.5.12.1 Operating Procedures	120
5.5.12.2 Precautions	122
5.6 Developing Simple Project	123
5.6.1 Overview of Simple Project	124
5.6.1.1 Symbolic Information	124
5.6.2 Development Procedure	125
5.6.2.1 Developing New Simple Projects on GX Works2	125
5.6.3 Developing Sequence Programs	126
5.6.3.1 CNC-Specific Restrictions	126
5.6.4 Writing the Sequence Program to the CNC Controller	128
5.6.4.1 Operation Procedure	128
5.6.4.2 Writing Operation	131
5.6.4.3 Operation and Check on Conversion Error	131
5.6.4.4 Other Operations and Checks on Error	133
5.6.5 Reading Sequence Programs from CNC Controller	135
5.6.5.1 Operation Procedure	135
5.6.6 Writing Sequence Programs to ROM in CNC	139
5.6.6.1 Operation Procedure	140
5.6.7 Verifying the Sequence Programs	141
5.6.7.1 Operation Procedure	141
5.6.8 Executing Ladder Program Writing during RUN	143
5.6.8.1 Execution Procedures of Ladder Program Writing during RUN	143
5.6.8.2 Setting Ladder Program Writing during RUN	144
5.6.8.3 PLC Data Available for Ladder Program Writing during RUN	144
5.6.8.4 Data Unit for Writing	145
5.6.8.5 Available Number of Steps for Writing	145
5.6.8.6 RUN Write Target Storage Area	146
5.6.8.7 Operation method on the GX Works2	147
5.6.8.8 Option Setting Screen for Ladder Program Writing during RUN (Online Change)	150
5.6.8.9 Precautions	151

5.6.9 Monitoring Sequence Programs	155
5.6.9.1 Operation Procedure	155
5.7 Developing Structured Project	156
5.7.1 Overview of Structured Project.....	156
5.7.1.1 Symbolic Information	157
5.7.2 Development Procedure.....	158
5.7.2.1 Developing New Simple Projects on GX Works2	158
5.7.3 Developing Sequence Programs.....	159
5.7.3.1 CNC-Specific Restrictions	159
5.7.4 Writing the Sequence Program to the CNC Controller	160
5.7.4.1 Operation Procedure	160
5.7.4.2 Writing Operation.....	161
5.7.4.3 Operation and Check on Conversion Error.....	161
5.7.4.4 Other Operations and Checks on Error	163
5.7.5 Reading Sequence Programs from CNC Controller.....	165
5.7.5.1 Operation Procedure	165
5.7.6 Writing Sequence Programs to ROM in CNC.....	167
5.7.6.1 Operation Procedure	167
5.7.7 Verifying the Sequence Programs.....	168
5.7.7.1 Operation Procedure	168
5.7.8 Monitoring Sequence Programs.....	170
5.7.8.1 Operation Procedure	170
5.8 PLC Message Development	171
5.8.1 Adding PLC Messages	171
5.8.2 Developing on Standard Screen	172
5.8.3 Writing Message Data on the Standard Screen	173
5.8.3.1 Description format.....	173
5.8.3.2 Description Method.....	174
5.8.3.3 File Name Rule	175
5.8.3.4 Precautions	176
5.8.4 Writing Message to CNC Controller on Standard Screen	177
5.8.4.1 Operation Procedure	177
5.8.5 Reading out from CNC Controller on Standard Screen	179
5.8.5.1 Operation Procedure	179
5.8.6 Development Procedure Using GX Works2.....	180
5.8.6.1 Development Using Text Editor	180
5.8.6.2 Inputting Messages Directly from GX Works2.....	180
5.8.7 Writing Message Data Using GX Works2	181
5.8.7.1 Written Form	181
5.8.7.2 How Message Data are Described	182
5.8.7.3 Precautions	183
5.8.8 Reading Message Data on GX Works2	184
5.8.8.1 Reading to GX Works2	184
5.8.8.2 Precautions	184
5.8.9 Inputting and Editing on GX Works2	185
5.8.9.1 Displaying Line Statements	185
5.8.9.2 Editing Integrated Line Statement	186
5.8.10 Writing CNC Controller on GX Works2.....	187
5.8.10.1 Operation Procedure	187
5.8.10.2 Writing Operation.....	187
5.8.10.3 Operation on Write Error.....	188
5.8.10.4 Checking Errors	189
5.8.11 Reading and Verifying Message Data on CNC Controller.....	190
5.8.11.1 Menu Selection and Screen Operation.....	190
5.8.12 How to Use on GX Works2 Message Data for GX Developer.....	190
5.8.12.1 When Data are Saved in Format Used in General Tools	190
5.8.12.2 When Data are Saved in GX Developer Format.....	190
5.9 Creating Device Comment	191
5.9.1 Development Procedure.....	191
5.9.2 Writing Method of Indirect Input	192
5.9.3 Reading Comment Data on GX Works2	193
5.9.3.1 Reading to GX Works2	193
5.9.3.2 Precautions	193
5.9.4 Writing Device Comments to CNC Controller.....	194
5.9.4.1 Operation Procedure	194
5.9.5 Reading Device Comments from CNC Controller	195
5.9.5.1 Operation Procedure	195

5.10	Creating Label	196
5.10.1	Overview of Label	196
5.10.2	Development Procedure	197
5.10.3	Writing Method of Indirect Input	198
5.10.4	Reading Label Setting on GX Works2	201
5.10.4.1	Reading to GX Works2.....	201
5.10.4.2	Precautions	201
5.10.5	Writing Label Setting to CNC Controller.....	202
5.10.5.1	Operation Procedure	202
5.10.6	Reading Label Setting from CNC Controller	203
5.10.6.1	Operation Procedure	203
5.10.7	Restrictions	204
5.11	Creating Function Block.....	206
5.11.1	Overview of Function Block.....	206
5.11.2	Write Function Block to CNC Controller.....	207
5.11.2.1	Operation Procedure	207
5.11.3	Reading Function Blocks from CNC Controller.....	208
5.11.3.1	Operation Procedure	208
5.11.4	Restrictions	209
5.12	File Password Function	210
5.12.1	Data Protected by a File Password.....	210
5.12.2	File Password Function.....	210
5.12.3	File Password Attributes	210
5.12.4	Outline of File Password Setting.....	211
5.12.5	Checking the File Password Registration Status	213
5.12.6	File Password: Cautions on Setting	214
5.12.7	File Password Setting Procedure.....	218
5.12.7.1	Registering New File Password	218
5.12.7.2	Changing File Passwords.....	221
5.12.7.3	Clearing File Password	223
5.12.7.4	Temporary Unlock of File Password	225
5.13	Corrective Actions to Resolve Errors.....	227
5.13.1	List of Errors during GX Works2 Online Operation	227
5.13.2	Checking PLC Alarms on CNC Controller.....	230
5.13.2.1	Operation Procedure	230
5.13.2.2	Details on Error Information Display.....	231
5.13.2.3	Displaying Detailed Error Information.....	232
5.13.2.4	Displaying of the Ladder in which an Error Occurred	233
5.13.3	Initializing PLC Data Storage Area.....	234
5.13.3.1	Operation Procedure	234
5.14	Backing Up Sequence Programs and Other Data	235
5.14.1	Backup of Entire PLC-related Data	235
5.14.1.1	Backup Target Data	235
5.14.1.2	Backup Procedures	236
5.14.1.3	Backup Data Restoration	237
5.14.1.4	Precautions	237
5.14.2	Batch Backup of PLC-Related Data for Each Project	239
5.14.2.1	Backup Target Data	239
5.14.2.2	Backup Procedure	240
5.14.2.3	Backup Data Restoration	241
5.14.2.4	Precautions	241
5.15	Project Protection Function.....	242
5.15.1	Project Protection Function of GX Works2.....	242
5.15.2	Project Protection Function of CNC	243
5.16	Displaying Project Verification Result in Ladder Diagram (GX Works3).....	244
5.16.1	Operation Procedure.....	245
5.17	Restrictions	248
5.17.1	Restrictions in Comparison with MELSEC PLC	248
5.17.1.1	Overall Restrictions	248
5.17.1.2	Restrictions on Simple Projects (with Labels)	248
5.17.1.3	Restrictions on Structured Projects	248
5.17.2	Differences from GX Developer	249
5.17.3	Multi-language Data	250
5.17.3.1	Creating Multi-language Data.....	250
5.17.3.2	Using Multi-language Data	250
5.17.4	Built-in PLC (Built-In Edit Function).....	251
5.17.5	Smart Safety Observation	251

5.17.6 Enhanced PLC Security Mode	251
5.18 Troubleshooting and FAQ	252
6 Explanation of Built-in Editing Function (PLC On-board).....	253
6.1 Outline	254
6.1.1 List of Project.....	254
6.1.2 List of Function	254
6.1.3 Operation Mode of Project	260
6.1.4 Language	261
6.2 Screen Configuration	262
6.2.1 Type	262
6.2.2 Configuration	264
6.2.2.1 Common Screen Items	264
6.2.2.2 Items Displayed on the Ladder Screen.....	265
6.2.2.3 Items Displayed on the Sampling Trace Screen.....	266
6.2.3 Menu Keys	267
6.2.3.1 Menu Key Tiers and Transitions	267
6.2.3.2 Menu Key Details.....	268
6.3 Operation Key List.....	274
6.3.1 Basic Operation Keys	274
6.3.2 Screen Items (Control)	275
6.4 Touch Gestures.....	282
6.4.1 Tap	282
6.4.2 Double-tap.....	286
6.4.3 Flick/Pan.....	289
6.4.4 Pinch-in/Pinch-out	290
6.5 Language	292
6.5.1 Screen Display Language	292
6.5.2 Language for Device Comments, Statements, Notes, and Machine Names	292
6.5.3 Precautions for Language Setting for GX Works2 Project	293
6.6 PLC Data.....	294
6.6.1 PLC Data Used by the PLC On-board	294
6.6.1.1 Sequence Program Details.....	295
6.6.1.2 PLC Message Details	295
6.6.1.3 Device Comment Details	295
6.6.1.4 Parameter Details.....	295
6.6.1.5 Trace File Details.....	296
6.6.1.6 CSV Format File Details	296
6.6.2 PLC Data Storage Areas	297
6.6.2.1 Readable PLC Data with PLC On-board	298
6.6.2.2 The Number of Ladder Files and PLC Message Files Available on One Project	298
6.6.2.3 Handling of PLC Data during External File Operation	299
6.6.2.4 Number of Files Storable	303
6.6.3 Passwords for PLC Data	304
6.6.3.1 Passwords for PLC Data Files.....	304
6.6.3.2 Block Passwords for PLC Data.....	307
6.6.3.3 Simultaneous Connection of PLC on-board and GX Developer/GX Works2	307
6.7 Starting.....	308
6.7.1 Starting the On-board.....	308
6.8 Ending the PLC on-board and Transitioning to the Mitsubishi Electric Standard Screen	309
6.8.1 Ending the PLC On-board	309
6.8.2 Transitioning to the Mitsubishi Electric Standard Screen	309
6.8.2.1 Method to Transition to the Mitsubishi Electric Standard Screen	309
6.9 Precautions when Using a Project with Labels	310
6.9.1 Compatible Types	310
6.9.2 Compatible Project Type	310
6.9.3 Function.....	310
6.9.4 File Password.....	310
6.9.5 Compatible POU	310
6.10 Precautions when Using a Structured Project.....	311
6.10.1 Compatible Types	311
6.10.2 Function.....	311
6.10.3 File Password.....	311
6.10.4 Compatible POU	311
6.10.5 Program Block with Program Setting Unset	311
6.11 Basic Operation.....	312

6.11.1 Basic Operation 1 (Configuring Multiple Project Parameters).....	312
6.11.1.1 Cases in which Sequence Programs are not Stored.....	312
6.11.1.2 Cases in which Sequence Programs are Stored.....	312
6.11.2 Basic Operation 2 (Creating Your First Program)	315
6.11.2.1 Adding New Sequence Programs	315
6.11.2.2 Editing the Sequence Program	317
6.11.2.3 Monitor the Sequence Program	319
6.11.3 Basic Operation 3 (Editing Programs Stored in the NC).....	321
6.11.3.1 Editing and Debugging the Sequence Program	321
6.11.3.2 Save the Sequence Program to the Internal ROM	323
6.11.4 Basic Operation 4 (Creating Multiple Sequence Programs)	324
6.11.4.1 Adding Sequence Programs	324
6.11.4.2 Configuring the Execution Order of Sequence Programs	326
6.11.4.3 Editing and Debugging the Sequence Program	328
6.11.4.4 Save the Sequence Program to the Internal ROM	330
6.11.5 Basic Operation 5 (Loading Programs Created with GX Developer/GX Works2).....	331
6.11.5.1 Saving PLC Data to an External Device.....	331
6.11.5.2 Saving PLC Data in External Devices to the NC	332
6.11.6 Basic Operation 6 (Updating the Program Version).....	334
6.11.6.1 Saving the Updated Version Data to an External Device	334
6.11.6.2 Updating the PLC Data Version in NC	335
6.12 Main Screen.....	336
6.12.1 Switching Menu Keys.....	336
6.12.1.1 Cases in which Sequence Programs are Stored.....	337
6.12.1.2 Cases in which Sequence Programs are not Stored.....	341
6.12.2 Screen Display Items	343
6.12.3 Enabled/Disabled State of Menu Keys.....	344
6.12.3.1 Cases in which Sequence Programs are Stored.....	344
6.12.3.2 Cases in which Sequence Programs are not Stored.....	344
6.12.4 SELECT PROJECT	345
6.12.5 Operation of Key Presses	346
6.12.5.1 Cases in which Sequence Programs are Stored.....	346
6.12.5.2 Cases in which Sequence Programs are not Stored.....	346
6.12.6 Returning to the Main Screen from Other Screens	346
6.13 NC File Operation Menus	347
6.13.1 NC File Operation Main Screen	347
6.13.1.1 Outline	347
6.13.1.2 Screen Display Items	347
6.13.1.3 Enabled/Disabled State of Menu Keys	348
6.13.1.4 Operation of Key Presses	348
6.13.2 File List Screen	349
6.13.2.1 Outline	349
6.13.2.2 Screen Display Items	350
6.13.2.3 Enabled/Disabled State of Menu Keys	350
6.13.2.4 Status during Screen Displays	350
6.13.2.5 Operation of Key Presses	351
6.13.2.6 Closing the File List Screen.....	351
6.13.3 Opened Screen	352
6.13.3.1 Outline	352
6.13.3.2 Screen Display Items	352
6.13.3.3 Enabled/Disabled State of Menu Keys	353
6.13.3.4 Status during Screen Displays	353
6.13.3.5 Operation of Key Presses	353
6.13.3.6 Opening PLC Data	354
6.13.3.7 Closing the Opened Screen	356
6.13.4 File Operation Screen	357
6.13.4.1 Outline	357
6.13.4.2 Screen Display Items	357
6.13.4.3 Enabled/Disabled State of Menu Keys	358
6.13.4.4 Status during Screen Displays	358
6.13.4.5 Operation of Key Presses	358
6.13.4.6 Closing the File Operation Screen	358
6.13.5 Add New Data Popup Screen	359
6.13.5.1 Outline	359
6.13.5.2 Screen Display Items	359
6.13.5.3 Enabled/Disabled State of Menu Keys.....	359
6.13.5.4 Status during Screen Displays	359

6.13.5.5	Operation of Key Presses	360
6.13.5.6	Adding PLC Data	360
6.13.5.7	Closing the Add New Data Popup Screen	361
6.13.6	Delete Data Popup Screen	362
6.13.6.1	Outline	362
6.13.6.2	Screen Display Items	362
6.13.6.3	Enabled/Disabled State of Menu Keys	362
6.13.6.4	Status during Screen Displays	363
6.13.6.5	Operation of Key Presses	363
6.13.6.6	Deleting PLC Data	363
6.13.6.7	Closing the Delete Data Popup Screen	364
6.13.7	Rename Data Popup Screen	365
6.13.7.1	Outline	365
6.13.7.2	Screen Display Items	365
6.13.7.3	Enabled/Disabled State of Menu Keys	365
6.13.7.4	Status during Screen Displays	366
6.13.7.5	Operation of Key Presses	366
6.13.7.6	Renaming the PLC Data	366
6.13.7.7	Closing the Rename Data Name Popup Screen	368
6.13.8	Format Popup Screen	369
6.13.8.1	Outline	369
6.13.8.2	Screen Display Items	369
6.13.8.3	Default Data	369
6.13.8.4	Enabled/Disabled State of Menu Keys	369
6.13.8.5	Status during Screen Displays	370
6.13.8.6	Operation of Key Presses	370
6.13.8.7	Formatting the Temporary Memory Area in the NC	370
6.13.8.8	Closing the Format Popup Screen	370
6.13.9	ROM Write Popup Screen	371
6.13.9.1	Outline	371
6.13.9.2	Screen Display Conditions	371
6.13.9.3	Enabled/Disabled State of Menu Keys	371
6.13.9.4	Operation of Key Presses	371
6.13.9.5	Writing PLC Data in the Temporary Memory Area into ROM	372
6.13.9.6	Closing the ROM Write Screen	372
6.13.10	PLC RUN/STOP Popup Screen	373
6.13.10.1	Outline	373
6.13.10.2	Screen Display Menus	373
6.13.10.3	Screen Display Items	373
6.13.10.4	Enabled/Disabled State of Menu Keys	374
6.13.10.5	Operation of Key Presses	374
6.13.10.6	Changing the PLC State for the Specified Project	374
6.13.10.7	Closing the PLC RUN/STOP Popup Screen	374
6.13.11	Cancel Password Popup Screen	375
6.13.11.1	Outline	375
6.13.11.2	Screen Display Items	375
6.13.11.3	Enabled/Disabled State of Menu Keys	376
6.13.11.4	Status during Screen Displays	376
6.13.11.5	Operation of Key Presses	376
6.13.11.6	Entering Passwords	377
6.13.11.7	Deleting Passwords	379
6.13.11.8	Canceling Passwords	379
6.13.11.9	Closing the Cancel Password Popup Screen	379
6.13.12	PLC Version Up Screen	380
6.13.12.1	Outline	380
6.13.12.2	Screen Display Items	381
6.13.12.3	Enabled/Disabled State of Menu Keys	382
6.13.12.4	Status during Screen Displays	382
6.13.12.5	Operation of Key Presses	382
6.13.12.6	Update the PLC Version	383
6.13.12.7	Closing the PLC Version Up Screen	389
6.13.13	Select Version Up Data Popup Screen	390
6.13.13.1	Outline	390
6.13.13.2	Screen Display Items	390
6.13.13.3	Enabled/Disabled State of Menu Keys	390
6.13.13.4	Status during Screen Displays	390
6.13.13.5	Storing Method of the Updating Version Data	391

6.13.13.6	Displaying Updating Version Data.....	392
6.13.13.7	Operation of Key Presses	393
6.13.13.8	Selecting Updating Version Data	393
6.13.13.9	Closing the Select Version Up Data Popup Screen	393
6.13.14	POU LIST screen.....	394
6.13.14.1	Outline.....	394
6.13.14.2	Screen Display Items	394
6.13.14.3	Enabled/Disabled State of Menu Keys.....	394
6.13.14.4	Status during Screen Displays	394
6.13.14.5	Operation of Key Presses	395
6.13.14.6	Display.....	395
6.13.14.7	Title.....	397
6.13.14.8	POU with Block Password.....	398
6.13.14.9	Block Password Disable	399
6.13.14.10	PWD Lock for All Data.....	399
6.14	External File Operation Menus	400
6.14.1	External File Operation Main Screen	400
6.14.1.1	Screen Display Items	400
6.14.1.2	Enabled/Disabled State of Menu Keys.....	400
6.14.2	"EXT." -> "NC" Screen	401
6.14.2.1	Outline	401
6.14.2.2	Screen Display Items	402
6.14.2.3	Enabled/Disabled State of Menu Keys.....	402
6.14.2.4	Status during Screen Displays	403
6.14.2.5	Operation of Key Presses	403
6.14.2.6	Reading External Project Data and Storing in the NC.....	403
6.14.2.7	Closing the "EXT.->NC" Screen	407
6.14.3	Select External Project Popup Screen	408
6.14.3.1	Outline	408
6.14.3.2	Screen Display Items	408
6.14.3.3	Enabled/Disabled State of Menu Keys.....	408
6.14.3.4	Status during Screen Displays	408
6.14.3.5	Displaying PLC Data	409
6.14.3.6	Operation of Key Presses	409
6.14.3.7	Select External Projects	410
6.14.3.8	Closing the Select External Project Popup Screen	411
6.14.4	"NC" -> "EXT." Screen	412
6.14.4.1	Outline	412
6.14.4.2	Screen Display Items	413
6.14.4.3	Enabled/Disabled State of Menu Keys.....	413
6.14.4.4	Status during Screen Displays	414
6.14.4.5	Operation of Key Presses	414
6.14.4.6	Storing PLC Data Stored in the Current Project into an External Device.....	414
6.14.4.7	Closing the "NC" -> "EXT." Screen	416
6.14.5	Save External Project Popup Screen.....	417
6.14.5.1	Outline	417
6.14.5.2	Screen Display Items	417
6.14.5.3	Enabled/Disabled State of Menu Keys.....	417
6.14.5.4	Status during Screen Displays	418
6.14.5.5	Displaying PLC Data	418
6.14.5.6	Operation of Key Presses	419
6.14.5.7	Saving to External Projects	419
6.14.5.8	Closing the Save External Project Popup Screen	421
6.14.6	Delete External File Popup Screen	422
6.14.6.1	Outline	422
6.14.6.2	Screen Display Items	422
6.14.6.3	Enabled/Disabled State of Menu Keys.....	422
6.14.6.4	Status during Screen Displays	423
6.14.6.5	Displaying PLC Data	423
6.14.6.6	Operation of Key Presses	424
6.14.6.7	Deleting External Projects	424
6.14.6.8	Closing the Delete External File Popup Screen	425
6.14.7	Verify External File Screen.....	426
6.14.7.1	Outline	426
6.14.7.2	Screen Display Items	426
6.14.7.3	Enabled/Disabled State of Menu Keys.....	427
6.14.7.4	Status during Screen Displays	427

6.14.7.5	Operation of Key Presses	427
6.14.7.6	Verifying PLC Data	428
6.14.7.7	Closing the Verify External File Screen	428
6.14.8	Verify Results Popup Screen	429
6.14.8.1	Outline	429
6.14.8.2	Screen Display Items	430
6.14.8.3	Enabled/Disabled State of Menu Keys	430
6.14.8.4	Status during Screen Displays	430
6.14.8.5	Operation of Key Presses	430
6.14.8.6	Closing the Verify Results Popup Screen	430
6.14.9	Cancel Password Popup Screen	431
6.14.9.1	Outline	431
6.14.10	Progress Screen	432
6.15	Ladder Menus	433
6.15.1	Ladder Monitor	433
6.15.1.1	Outline	433
6.15.1.2	Screen Display Items	433
6.15.1.3	Enabled/Disabled State of Menu Keys	434
6.15.1.4	Operation of Key Presses	434
6.15.1.5	Ladder Display	435
6.15.1.6	Moving the Cursor	437
6.15.1.7	Starting and Stopping the Monitor	437
6.15.2	Editing Ladders	438
6.15.2.1	Outline	438
6.15.2.2	Screen Display Items	439
6.15.2.3	Enabled/Disabled State of Menu Keys	439
6.15.2.4	Operation of Key Presses	440
6.15.2.5	Moving the Cursor	440
6.15.2.6	Editing Ladders	441
6.15.2.7	Converting Programs	450
6.15.2.8	Undoing the Last Edit Operation	451
6.15.2.9	Editing Statements	451
6.15.2.10	Editing Notes	453
6.15.2.11	Ladder Program Writing during RUN by Conversion	454
6.15.3	Find Popup Screen	456
6.15.3.1	Outline	456
6.15.3.2	Screen Display Items	457
6.15.3.3	Enabled/Disabled State of Menu Keys	457
6.15.3.4	Status during Screen Displays	457
6.15.3.5	Operation of Key Presses	458
6.15.3.6	Displaying the Find Popup Screen	458
6.15.3.7	Find Operation	459
6.15.3.8	Returning to the Start Position	463
6.15.3.9	Register Monitor Operation	463
6.15.3.10	Find Popup Screen Errors	464
6.15.3.11	Closing the Find Popup Screen	464
6.15.4	Find Step No. Popup Screen	465
6.15.4.1	Outline	465
6.15.4.2	Screen Display Items	465
6.15.4.3	Enabled/Disabled State of Menu Keys	465
6.15.4.4	Status during Screen Displays	465
6.15.4.5	Operation of Key Presses	466
6.15.4.6	Displaying the Find Step No. Popup Screen	466
6.15.4.7	Finding Step Numbers	466
6.15.4.8	Closing the Find Step No. Popup Screen	466
6.15.5	Device Test Popup Screen	467
6.15.5.1	Outline	467
6.15.5.2	Screen Display Items	468
6.15.5.3	Enabled/Disabled State of Menu Keys	468
6.15.5.4	Status during Screen Displays	468
6.15.5.5	Operation of Key Presses	469
6.15.5.6	Testing Bit Devices	469
6.15.5.7	Testing Word Devices	470
6.15.5.8	Closing the Device Test Popup Screen	471
6.15.5.9	Precautions when Executing Device Test with Label Name	471
6.15.6	Contact Coil Usage List Popup Screen	472
6.15.6.1	Outline	472

6.15.6.2	Screen Display Items	472
6.15.6.3	Enabled/Disabled State of Menu Keys	472
6.15.6.4	Status during Screen Displays	473
6.15.6.5	Operation of Key Presses	473
6.15.6.6	Investigating Usage States of Specified Devices	473
6.15.6.7	Closing the Contact Coil Usage List Popup Screen	474
6.15.7	List of Used Devices Popup Screen.....	475
6.15.7.1	Outline	475
6.15.7.2	Screen Display Items	475
6.15.7.3	Enabled/Disabled State of Menu Keys	475
6.15.7.4	Status during Screen Displays	476
6.15.7.5	Operation of Key Presses	476
6.15.7.6	Investigating Usage States of Devices	476
6.15.7.7	Closing the List of Used Devices Popup Screen	477
6.15.8	Check Program Popup Screen	478
6.15.8.1	Outline	478
6.15.8.2	Screen Display Items	478
6.15.8.3	Enabled/Disabled State of Menu Keys	478
6.15.8.4	Status during Screen Displays	479
6.15.8.5	Operation of Key Presses	479
6.15.8.6	Checking Programs.....	479
6.15.8.7	Closing the Check Program Popup Screen.....	480
6.15.9	Split Screen.....	480
6.15.9.1	Entry Device Monitor	480
6.15.9.2	Entry Ladder Monitor	483
6.15.10	FB Instance Monitor Screen.....	486
6.15.10.1	Outline	486
6.15.10.2	Screen display items	487
6.15.10.3	Enabled/Disabled State of Menu Keys	487
6.15.10.4	Operation of Key Presses	487
6.15.10.5	Start FB Instance Monitor	488
6.15.10.6	Close FB Instance Monitor	488
6.15.11	Block Password Disable screen.....	489
6.15.11.1	Outline	489
6.15.11.2	Screen display items	489
6.15.11.3	Enabled/Disabled State of Menu Keys	489
6.15.11.4	Operation of Key Presses	489
6.15.11.5	Canceling Block Password.....	489
6.15.11.6	Block Password Disable Screen	489
6.15.12	Switching Programs	490
6.15.12.1	Outline	490
6.15.12.2	Selecting and Switching Programs.....	491
6.15.12.3	Block Password Disable	491
6.16	Environment Setting Menus.....	492
6.16.1	Environment Settings Main Screen.....	492
6.16.1.1	Outline	492
6.16.1.2	Screen Display Items	492
6.16.1.3	Enabled/Disabled State of Menu Keys	493
6.16.1.4	Operation of Key Presses	493
6.16.2	Comment Display Settings Screen	494
6.16.2.1	Outline	494
6.16.2.2	Screen Display Items	494
6.16.2.3	Enabled/Disabled State of Menu Keys	495
6.16.2.4	Status during Screen Displays	495
6.16.2.5	Operation of Key Presses	496
6.16.2.6	Common Comment File	497
6.16.2.7	Setting the Comment Display State	498
6.16.2.8	Closing the Comment Display Settings Screen.....	498
6.16.3	Ladder Display Settings Screen.....	499
6.16.3.1	Outline	499
6.16.3.2	Screen Display Items	499
6.16.3.3	Enabled/Disabled State of Menu Keys	500
6.16.3.4	Status during Screen Displays	500
6.16.3.5	Operation of Key Presses	500
6.16.3.6	Setting the Ladder Display State.....	501
6.16.3.7	Closing the Ladder Display Settings Screen	501
6.16.4	GX Works2 Setting Screen	502

6.16.4.1	Outline	502
6.16.4.2	Screen Display Items	502
6.16.4.3	Enabled/Disabled State of Menu Keys	502
6.16.4.4	Status during Screen Displays	502
6.16.4.5	Operation of Key Presses	503
6.16.4.6	Setting Project Language	503
6.16.4.7	Closing GX Works2 Settings Screen	503
6.16.5	Change NC Connection Screen	504
6.16.5.1	Outline	504
6.16.5.2	Screen Display Items	505
6.16.5.3	Enabled/Disabled State of Menu Keys	505
6.16.5.4	Status during Screen Displays	505
6.16.5.5	Operation of Key Presses	505
6.16.5.6	Changing the NC Connection	506
6.16.5.7	Closing the Change NC Connection Screen	506
6.17	Device Menus	507
6.17.1	Device Main Screen	507
6.17.1.1	Outline	507
6.17.1.2	Screen Display Items	507
6.17.1.3	Enabled/Disabled State of Menu Keys	507
6.17.1.4	Operation of Key Presses	507
6.17.2	Device Batch Monitor Screen	508
6.17.2.1	Outline	508
6.17.2.2	Screen Display Items	508
6.17.2.3	Enabled/Disabled State of Menu Keys	509
6.17.2.4	Status during Screen Displays	509
6.17.2.5	Operation of Key Presses	509
6.17.2.6	Starting and Stopping the Monitor for the Selected Device	510
6.17.2.7	Closing the Device Batch Monitor Screen	510
6.17.3	Entry Device Monitor Screen	511
6.17.3.1	Outline	511
6.17.3.2	Screen Display Items	511
6.17.3.3	Enabled/Disabled State of Menu Keys	512
6.17.3.4	Status during Screen Displays	512
6.17.3.5	Operation of Key Presses	512
6.17.3.6	Entering Devices for Monitoring	513
6.17.3.7	Deleting Devices	513
6.17.3.8	Starting and Stopping the Monitor for the Selected Device	514
6.17.3.9	Closing the Entry Device Monitor Screen	514
6.17.4	Sampling Trace	515
6.17.4.1	Sampling Trace Main Screen	520
6.17.4.2	Trace Count Setup Screen	521
6.17.4.3	Trace Point Setup Screen	524
6.17.4.4	Trigger Point Setup Screen	530
6.17.4.5	Trace Data Setup Screen	533
6.17.4.6	Trace Execution Screen	537
6.17.4.7	Trace Result Display Screen	540
6.17.4.8	Create CSV File Screen	544
6.17.4.9	Storage Setting Popup Screen	546
6.17.4.10	Trace File Read Screen	548
6.17.4.11	Trace File Write Screen	551
6.17.4.12	Trace File Delete Screen	554
6.17.4.13	Example of Trace File Write	556
6.18	Parameter Menus	559
6.18.1	Parameter Main Screen	559
6.18.1.1	Outline	559
6.18.1.2	Screen Display Items	559
6.18.1.3	Enabled/Disabled State of Menu Keys	559
6.18.1.4	Operation of Key Presses	559
6.18.2	Program Settings Screen	560
6.18.2.1	Outline	560
6.18.2.2	Screen Display Items	560
6.18.2.3	Enabled/Disabled State of Menu Keys	561
6.18.2.4	Status during Screen Displays	561
6.18.2.5	Operation of Key Presses	561
6.18.2.6	Setting the Program Execution Sequence	561
6.18.2.7	Abnormal operation	562

6.18.2.8 Closing the Program Settings Screen	562
6.18.3 Common Pointer Settings Screen	563
6.18.3.1 Outline	563
6.18.3.2 Screen Display Items	563
6.18.3.3 Enabled/Disabled State of Menu Keys	564
6.18.3.4 Status during Screen Displays	564
6.18.3.5 Operation of Key Presses	564
6.18.3.6 Closing the Common Pointer Screen	564
6.18.4 Multiple Project Parameters Main Screen	565
6.18.4.1 Outline	565
6.18.4.2 Screen Display Items	565
6.18.4.3 Enabled/Disabled State of Menu Keys	565
6.18.4.4 Operation of Key Presses	565
6.18.5 Project Settings Screen	566
6.18.5.1 Outline	566
6.18.5.2 Screen Display Items	566
6.18.5.3 Enabled/Disabled State of Menu Keys	567
6.18.5.4 Status during Screen Displays	567
6.18.5.5 Operation of Key Presses	567
6.18.5.6 Setting the Project Ratio	568
6.18.5.7 Setting Execution Projects	569
6.18.5.8 Setting the Execution Sequence	570
6.18.5.9 Configuring the Project Settings	571
6.18.5.10 Closing the Project Settings Screen	571
6.18.6 Device Settings Screen	572
6.18.6.1 Outline	572
6.18.6.2 Screen Display Items	572
6.18.6.3 Enabled/Disabled State of Menu Keys	573
6.18.6.4 Status during Screen Displays	573
6.18.6.5 Operation of Key Presses	573
6.18.6.6 Entering the Number of Devices	573
6.18.6.7 Configuring Device Settings	574
6.18.6.8 Closing the Device Settings Screen	575
6.19 PLC Diagnosis Menus	576
6.19.1 PLC Diagnosis Screen	576
6.19.1.1 Outline	576
6.19.1.2 Screen Display Items	576
6.19.1.3 Enabled/Disabled State of Menu Keys	577
6.19.1.4 Status during Screen Displays	577
6.19.1.5 Operation of Key Presses	577
6.19.1.6 Rotary Switch Status	577
6.19.1.7 Error Display	578
6.19.1.8 Error Jump	578
6.19.1.9 Closing the PLC Diagnosis Screen	578
6.20 Software Keyboard	579
6.20.1 Outline	579
6.20.2 Description of Keys	580
6.20.2.1 Alphanumeric Keys, Symbol Keys	580
6.20.3 Special Keys	580
6.21 Canceling File Passwords	582
6.21.1 Outline	582
6.21.2 Canceling Individual File Passwords	583
6.21.2.1 Screen Display Items	583
6.21.2.2 Enabled/Disabled State of Menu Keys	583
6.21.2.3 Status during Screen Displays	583
6.21.2.4 Operation of Key Presses	583
6.21.2.5 Canceling Passwords	584
6.21.2.6 Closing the Cancel Individual File Passwords Screen	584
6.21.3 Canceling Batch File Passwords	584
6.22 Restrictions	585
6.22.1 Enhanced PLC Security Mode	585

7 Appendix 1: Comparison of PLC Related Sections in Each Model..... 587

7.1 Device Comparison	588
-----------------------------	-----

8 Appendix 2: List of PLC Alarms 589

9 Appendix 3: PLC Function	601
9.1 Enhanced PLC Security Mode	602
9.1.1 Function Details	603
9.1.1.1 Definitions of Terms	603
9.1.1.2 Enabling Conditions	603
9.1.1.3 PLC Write Protect Mode	604
9.1.1.4 PLC Read/Write Protect Mode	604
9.1.1.5 E/U mode	605
9.1.1.6 Functions Available in Each Mode	613
9.1.1.7 The Connection Restriction on GX Developer/GX Works2	616
9.1.1.8 File Password	616
9.1.2 Relationship with Other Functions	616
9.1.2.1 Built-in PLC (Built-in Edit Function)	616
9.1.2.2 Built-in PLC (Peripheral Development Environment)	616
9.1.2.3 Built-in PLC (Peripheral Development Environment (GX Works2))	616
9.1.2.4 Protection Setting Screen	616
9.1.3 Precautions	617
9.1.4 Information to be Shared with End Users	618



Definitions of Terms

1 Definitions of Terms

The following table provides descriptions of the terms used in this manual.

Term	Description
GX Developer	Mitsubishi Electric FA engineering software GX Developer
GX Works2	Mitsubishi Electric FA engineering software GX Works2
On-board/PLC On-board	A generic term for operations related to the PLC carried out with the Mitsubishi Electric CNC.
User safety sequence	A sequence that runs and observes dual sequences independently and utilizes the "safety-related I/O observation" to detect failures in one of the sequences.
Simple project	A project created in GX Works2 using ladder, SFC, and ST language.
Project with labels	Refers to the following: <ul style="list-style-type: none"> • A project created with the setting to use labels created in GX Developer • A simple project created with the setting to use labels created in GX Works2 In "6 Explanation of Built-in Editing Function (PLC On-board)", this mainly refers to a simple project created with the setting to use labels created in GX Works2.
Project without labels	Refers to the following: <ul style="list-style-type: none"> • A project created with the setting to not use labels created in GX Developer • A simple project created with the setting to not use labels created in GX Works2 In "6 Explanation of Built-in Editing Function (PLC On-board)", this mainly refers to a project created with the setting to not use labels created in GX Developer.
Structured project	A project created in GX Works2 using ladder, SFC, ST, structured ladder, and FBD language.
FB	The abbreviation for function block. A function block is a ladder block used repeatedly in a sequence program that is converted into a component so that it can be used in a sequence program.
FB instance	An FB pasted in a sequence program.
GX Developer format	The data format when a project is saved in GX Developer.
GX Works2 format	The data format when a project is saved in GX Works2.
Operation mode	The operation mode of the selected project. There are two operation modes: GX Developer and GX Works2. The operation modes support each project format.
Title	The character string that can be given to data. This is called the "title" in a GX Works2 project.
Program block	Refers to a program which is an element in a POU (Program Organization Unit) of a structured project.

System Configuration of H/W

2.1 System Configuration

[M800VW/M80VW]

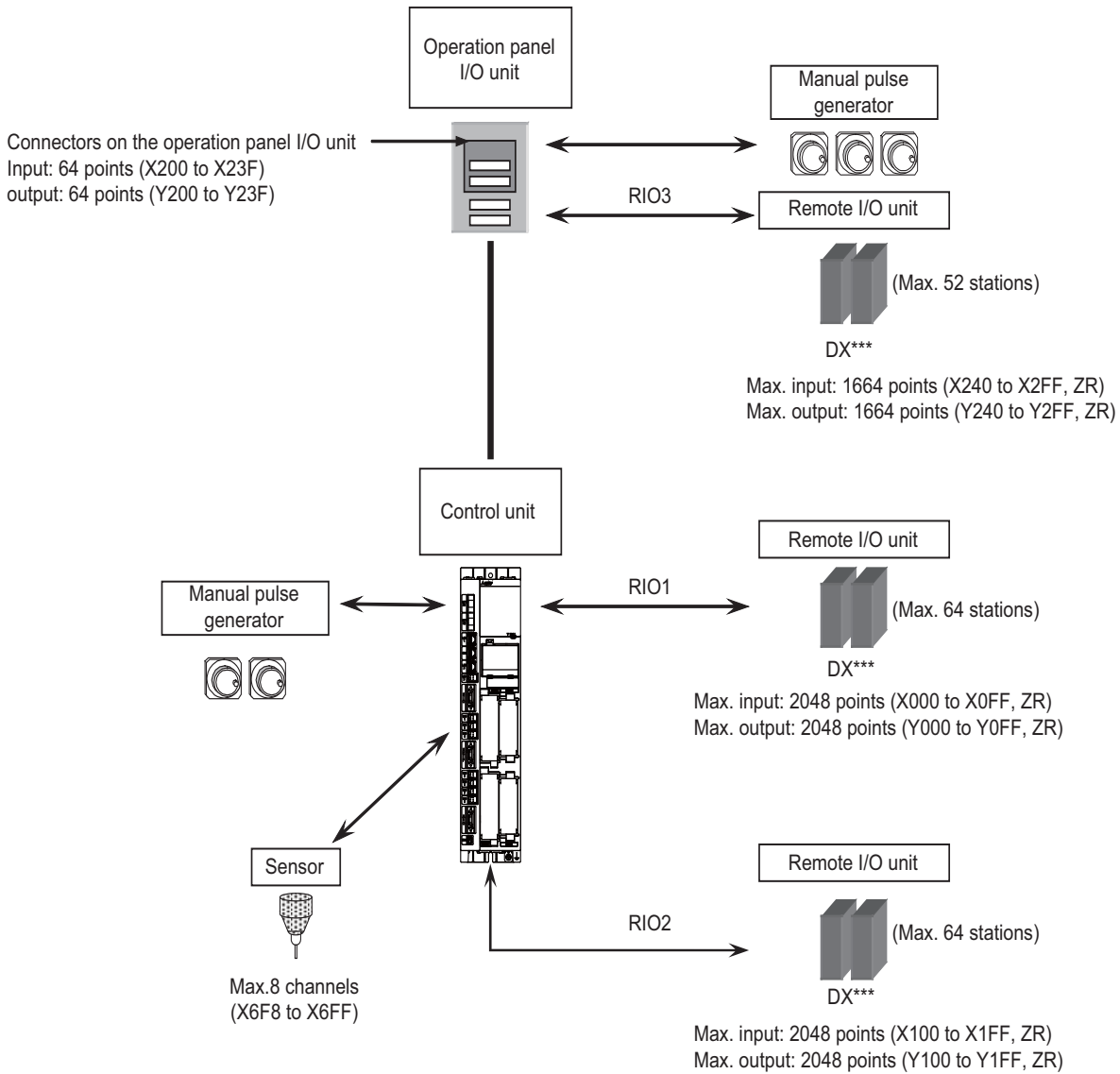

It is possible to connect up to three manual pulse generators.

Refer to "1ST HANDLE AXIS SELECTION CODE m (HS11 to 116)" in "PLC Output Signals (Bit Type: Y***)" on "PLC Interface Manual" for the connection point of the manual pulse generator and the handle No.

Digital signals (DI/DO) can be arbitrarily assigned to PLC devices with the parameters.

Refer to the precautions of "2.2.2 PLC Device Assignment of Digital Signal (DI/DO)" for details.

[M800VS/M80V]

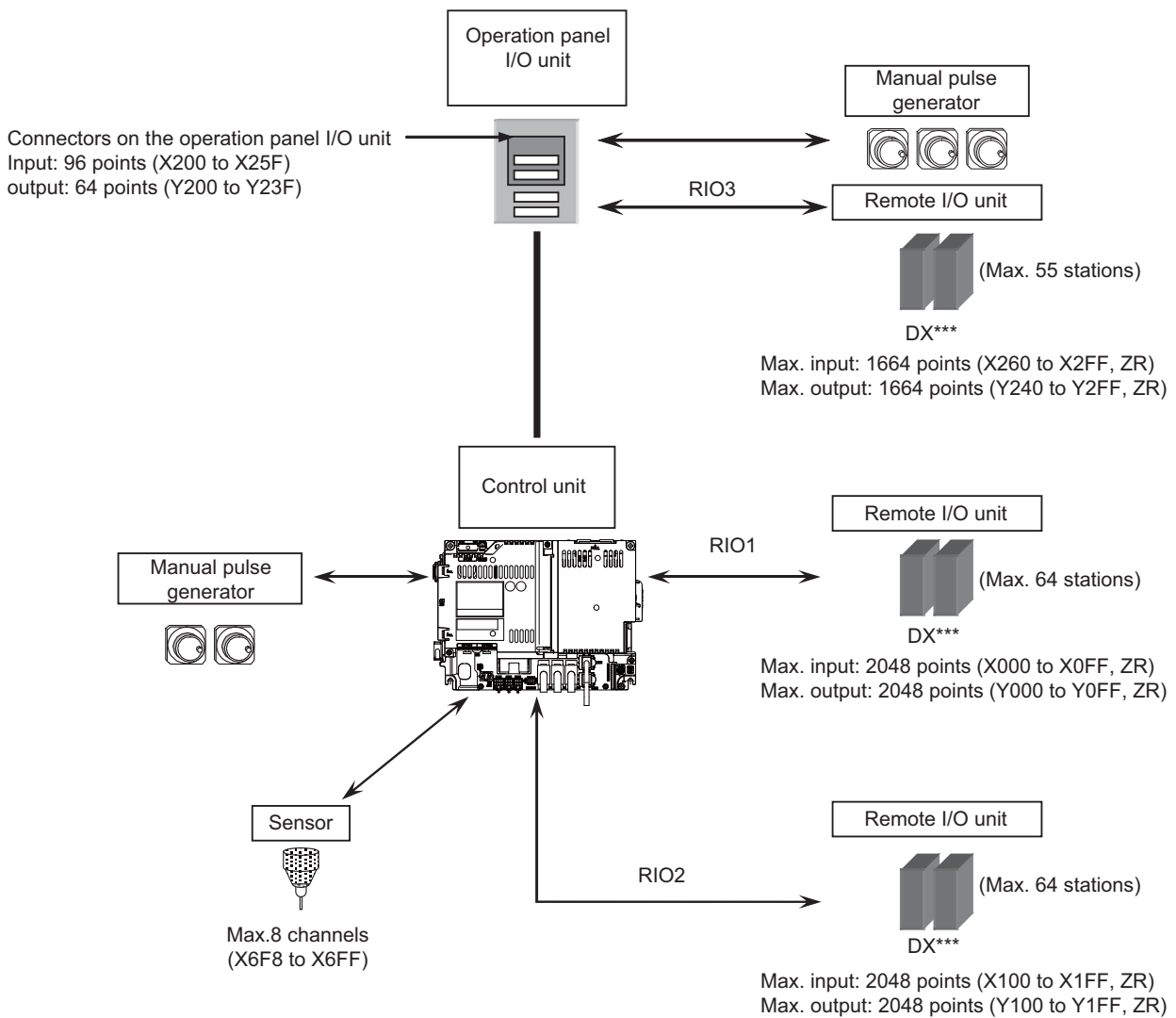

It is possible to connect up to three manual pulse generators.

Refer to "1ST HANDLE AXIS SELECTION CODE m (HS11 to 116)" in "PLC Output Signals (Bit Type: Y***)" for the connection point of the manual pulse generator and the handle No.

Digital signals (DI/DO) can be arbitrarily assigned to PLC devices with the parameters.

Refer to "2.2.2 PLC Device Assignment of Digital Signal (DI/DO)" for details.

2.2 Relation of RIO Unit and Devices

2.2.1 Outline of the Remote I/O Unit

The specification varies for each remote I/O unit.

Each unit has one or two rotary switch(es) that determines the unit No. and associates the unit with its device No. (with X/Y).

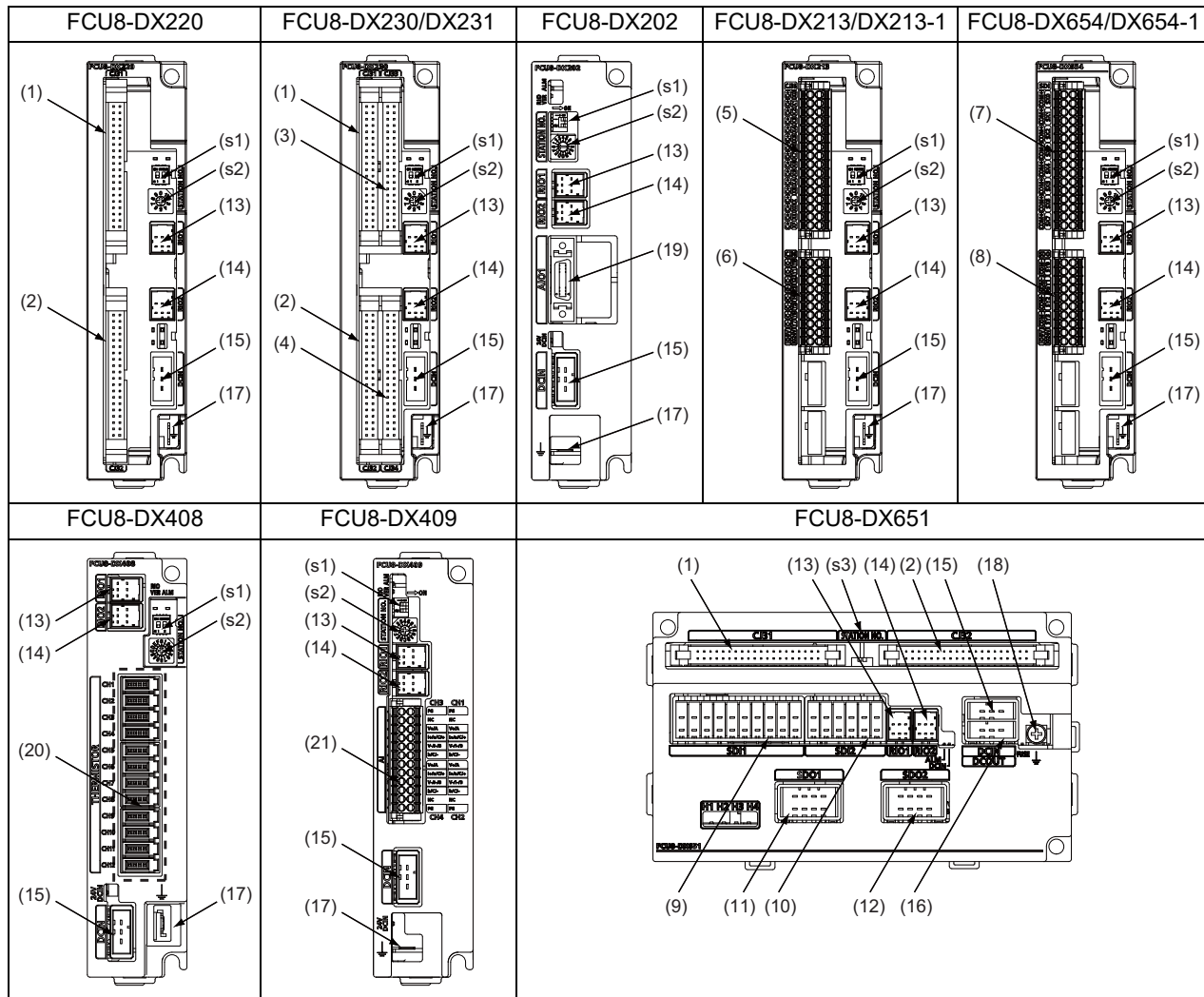

No.	Connector name	Function
(1)	CJ31	Machine signal input
(2)	CJ32	Machine signal output
(3)	CJ33	Machine signal input
(4)	CJ34	Machine signal output
(5)	CJ35	Machine signal input
(6)	CJ36	Machine signal output
(7)	SDI	Safety machine signal input
(8)	SDO	Safety machine signal output
(9)	SDI1	Safety DI input
(10)	SDI2	Safety DI input
(11)	SDO1	Safety relay output

No.	Connector name	Function
(12)	SDO2	Safety relay output
(13)	RIO1	Remote I/O 2.0 communication
(14)	RIO2	Remote I/O 2.0 communication
(15)	DCIN	24 VDC input
(16)	DCOUT	24 VDC output
(17)	FG	FG terminal
(18)	FG	FG terminal (M4 screw)
(19)	AIO1	Analog input Analog output
(20)	THERMISTOR	Thermistor input
(21)	AI	Multi-analog input

No.	Switch name	Function
(s1)		Station No. group setting switch
(s2)	STATION No.	Station No. setting switch
(s3)		Station No. setting switch

2 System Configuration of H/W

2.2 Relation of RIO Unit and Devices

Unit type	Machine control signals that can be handled	Total	Number of occupied stations
FCU8-DX220	Digital input signal (DI)	32 points	1
	Digital output signal (DO)	32 points	
FCU8-DX230	Digital input signal (DI)	64 points	2
	Digital output signal (DO)	48 points	
FCU8-DX231	Digital input signal (DI)	64 points	2
	Digital output signal (DO)	48 points	
	Analog output (AO)	1 point	
FCU8-DX202	Analog input signal (AI)	4 points	1
	Analog output signal (AO)	1 point	
FCU8-DX213/DX213-1	Digital input signal (DI)	16 points	1
	Digital output signal (DO)	8 points	
FCU8-DX654/DX654-1	Safety digital input signal (DI)	8 points	2
	Safety digital output signal (DO)	4 points	
FCU8-DX651	Digital input signal (DI)	32 points	3
	Digital output signal (DO)	32 points	
	Safety digital input signal (DI)	8 points	
	Safety digital output signal (DO)	4 points	
FCU8-DX408	Thermistor input (THERMISTOR)	12 points	3
FCU8-DX409	Multi-analog input (Multi AI)	4 points	4

2.2.2 PLC Device Assignment of Digital Signal (DI/DO)

The input/output signals (analog signal, DI/DO, etc.) are assigned to the PLC devices, and the digital signals (DI/DO) can be assigned to the arbitrary PLC devices by the parameters.

Either "Fixed device assignment" which automatically assigns the signals to fixed PLC devices defined by the system or "Arbitrary device assignment" which user can assign the signals the arbitrary PLC devices by the parameters can be selected by setting the RIO assignment parameter "#53001 RIO dev assign" (selection of RIO device assignment method).

[Fixed device assignment]: Parameter "#53001 RIO dev assign" is set to "0".

Settings are not required because the assignment to the fixed PLC devices are automatically performed.

Refer to "2.2.2.1 Fixed Device Assignment" for details.

[Arbitrary device assignment]: Parameter "#53001 RIO dev assign" is set to "1".

Set the PLC devices which are assigned to the DI/DO of each remote I/O unit station by the parameters.

Refer to "2.2.2.2 Arbitrary Device Assignment" for details.

2.2.2.1 Fixed Device Assignment

- By setting the parameter "#53001 RIO dev assign" to "0", the PLC device assignment method, which is to be used for input/output of each remote I/O unit station, will be the fixed device assignment.
- PLC devices assigned for each remote I/O unit station at the time of the fixed device assignment are as follows:

Channel No.		Station No.							
		1	2	...	8	9	...	63	64
RIO1	Input device	X0000 to X001F	X0020 to X003F	...	X00E0 to X00FF	ZR5000 /ZR5001	...	ZR5108 /ZR5109	ZR5110 /ZR5111
	Output device	Y0000 to Y001F	Y0020 to Y003F	...	Y00E0 to Y00FF	ZR6000 /ZR6001	...	ZR6108 /ZR6109	ZR6110 /ZR6111
RIO2	Input device	X0100 to X011F	X0120 to X013F	...	X01E0 to X01FF	ZR5200 /ZR5201	...	ZR5308 /ZR5309	ZR5310 /ZR5311
	Output device	Y0100 to Y011F	Y0120 to Y013F	...	Y01E0 to Y01FF	ZR6200 /ZR6201	...	ZR6308 /ZR6309	ZR6310 /ZR6311
RIO3	Input device	X0200 to X021F	X0220 to X023F	...	X02E0 to X02FF	ZR5400 /ZR5401	...	ZR5508 /ZR5509	ZR5510 /ZR5511
	Output device	Y0200 to Y021F	Y0220 to Y023F	...	Y02E0 to Y02FF	ZR6400 /ZR6401	...	ZR6508 /ZR6509	ZR6510 /ZR6511

Note

- (1) Do not use the input/output signals of the system-occupied stations of RIO3 and operation panel I/O unit-connected channels.
- A part of PLC devices assigned for each station of remote I/O units can input/output signals with PLC high speed by setting the high-speed input/output specification parameters or R registers.
 - The devices for inputting/outputting signals with PLC high speed can be set individually for the high-order and the low-order per 16 points for DI and DO of each remote I/O unit station.
 - Only devices of the first to eighth stations for each remote I/O channel can input/output signals with PLC high speed. The devices of the ninth to 64th stations input/output with PLC medium speed.
 - The parameter and R register numbers for the high-speed input/output designation are as follows:

Channel No.		Station No.			
		1 to 4		5 to 8	
		Parameter No.	R register No.	Parameter No.	R register No.
RIO1	High-speed input specification	# 6457	R7828 low-order	# 6458	R7828 high-order
	High-speed output specification	# 6461	R7830 low-order	# 6462	R7830 high-order
RIO2	High-speed input specification	# 6459	R7829 low-order	# 6460	R7829 high-order
	High-speed output specification	# 6463	R7831 low-order	# 6464	R7831 high-order
RIO3	High-speed input specification	# 6465	R7832 low-order	# 6466	R7832 high-order
	High-speed output specification	# 6473	R7836 low-order	# 6474	R7836 high-order

Note

- (1) The above parameters are invalid when the devices have been assigned arbitrarily.
- (2) Refer to "PLC Programming Manual" for details of the setting method.

2.2.2.2 Arbitrary Device Assignment

Parameter setting for device arbitrary assignment

- By setting the parameter "#53001 RIO dev assign" to "1", the assignment method for PLC devices to be used for input/output of each remote I/O unit station becomes arbitrary device assignment.
- For arbitrary device assignment, set the PLC devices for input and output to DI/DO (32 points) of each remote I/O unit station by the parameters. Also, set the assignment of the operation panel I/O unit.
- Turn the power OFF and ON to enable arbitrary device assignment after the parameter settings.
- Set the input/output device assignment and high-speed input/output specification by the parameters for each station of all remote units which have DI/DO function (except safety DI/DO). If all stations have not been set, the alarm "Y05 Initial parameter error" will be issued when the power turns ON.

Name	Parameter set No. (*1)								
	#1	...	#64	#65	...	#128	#129	...	#182
Target channel No. #n	#53011	...	#53641	#53651	...	#54281	#54291	...	#54821
Target station No. #n (*2)	#53012	...	#53642	#53652	...	#54282	#54292	...	#54822
DI device name #n	#53013	...	#53643	#53653	...	#54283	#54293	...	#54823
DI device No. #n	#53014	...	#53644	#53654	...	#54284	#54294	...	#54824
DO device name #n	#53015	...	#53645	#53655	...	#54285	#54295	...	#54825
DO device No. #n	#53016	...	#53646	#53656	...	#54286	#54296	...	#54826
High-speed input specification #n	#53017	...	#53647	#53657	...	#54287	#54297	...	#54827
High-speed output specification #n	#53018	...	#53648	#53658	...	#54288	#54298	...	#54828

(*1) A set of RIO assignment parameters consists of eight parameters (from target channel number to high-speed output specification) for one station.

(*2) Arbitrary device assignment cannot be performed for the system-occupied stations of RIO3 and operation panel I/O unit-connected channels.

- The PLC devices that are valid for arbitrary device assignment are as follows:

PLC device	Word/Bit	Input	Output	Assignable range	PLC device No. format
X	Bit	○	-	X0000 to X05FF When PROFIBUS specification is added. X400 to X5FF are unavailable.	Hexadecimal
Y	Bit	-	○	Y0000 to Y05FF When PROFIBUS specification is added. Y400 to Y5FF are unavailable.	Hexadecimal
ZR	Word	○	○	ZR5000 to ZR5999 (for input) ZR6000 to ZR6999 (for output)	Decimal

Note

- Duplication check is not performed between the PLC devices which are set with machine input/output signal other than the remote I/O such as CC-Link or PROFIBUS and PLC devices which are set with arbitrary device assignment. If the PLC devices have duplicated, NC or PLC ladder can not be carried out correctly. When using machine input/output signal other than the remote I/O, make sure to confirm that the PLC devices do not duplicate the PLC devices set with arbitrary device assignment.
 - Assignment cannot be performed for the devices corresponding to the system-occupied stations of RIO3. If you connect the operation panel to any channel other than RIO3, assignment is also disabled for the devices corresponding to the system-occupied stations of the said channel.
- Even when the RIO assignment parameters are set in the remote I/O unit stations which have the analog input/output and safety DI/DO functions, the input/output is not carried out to the set PLC devices.

2 System Configuration of H/W

2.2 Relation of RIO Unit and Devices

- Up to 24 stations can be specified for high-speed input/output specification each for input and output. If 25 or more stations are specified, the alarm "Y05 Initial parameter error" will be issued.
- High-speed input/output specification can be set by R registers below as well as the RIO assignment parameters.

Channel No.		Station No.							
		1 to 8	9 to 16	17 to 24	25 to 32	33 to 40	41 to 48	49 to 56	57 to 64
RIO1	High-speed input specification	R30544 low-order	R30544 high-order	R30545 low-order	R30545 high-order	R30546 low-order	R30546 high-order	R30547 low-order	R30547 high-order
	High-speed output specification	R30560 low-order	R30560 high-order	R30561 low-order	R30561 high-order	R30562 low-order	R30562 high-order	R30563 low-order	R30563 high-order
RIO2	High-speed input specification	R30548 low-order	R30548 high-order	R30549 low-order	R30549 high-order	R30550 low-order	R30550 high-order	R30551 low-order	R30551 high-order
	High-speed output specification	R30564 low-order	R30564 high-order	R30565 low-order	R30565 high-order	R30566 low-order	R30566 high-order	R30567 low-order	R30567 high-order
RIO3	High-speed input specification	R30552 low-order	R30552 high-order	R30553 low-order	R30553 high-order	R30554 low-order	R30554 high-order	R30555 low-order	R30555 high-order
	High-speed output specification	R30568 low-order	R30568 high-order	R30569 low-order	R30569 high-order	R30570 low-order	R30570 high-order	R30571 low-order	R30571 high-order

Note

- (1) Turn the power OFF and ON after the R register settings to enable the settings.
- (2) One bit of each R register is equivalent to one station. The high-speed input/output specification can be performed by turning ON the R register bits of the stations to be input or output with PC high speed. To output the 10th station of RIO1 at high speed, for instance, turn bit9 of R30544 ON.
- (3) High-speed input/output designation is disabled for the system-occupied stations of RIO3 and operation panel I/O unit-connected channels.
Even when the bit6 to bitD of R30552 and R30568 are turned ON, they will be invalid.
- (4) The above settings are invalid with fixed device assignment.

2 System Configuration of H/W

2.2 Relation of RIO Unit and Devices

- In the following cases, the alarm "Y05 Initial parameter error" will be issued when the power is turned ON. The number of the RIO assignment parameter with illegal setting state will be displayed.

(a) The value outside the range of setting has been set to the RIO assignment parameter (except "#53001 RIO dev assign").

(b) Two or more stations of the target channel No. and the target station No. are set redundantly to the RIO assignment parameters.

(Example) The power is turned ON in a state where the 1st and 2nd station of RIO1 are set redundantly to the RIO assignment parameters #1 to #5 as shown in the table below.

(Both the 1st and 2nd stations are connected to the NC control unit.)

Parameter set No.#n	Target channel No. #N (Parameter No.)	Target station No. #N (Parameter No.)	Setting state
1	1 (#53011)	0 (#53012)	RIO1 1st station is set
2	1 (#53021)	1 (#53022)	RIO1 2nd station is set
3	1 (#53031)	1 (#53032)	RIO1 2nd station is set
4	1 (#53041)	0 (#53042)	RIO1 1st station is set
5	1 (#53051)	0 (#53052)	RIO1 1st station is set

<Result>

The parameter number (53031) of "Target channel #3" will be displayed on the alarm "Y05 Initial parameter error".

Duplication error of RIO1 second station will be detected first because the RIO assignment parameter is checked from the top. Between the parameter set #2 and #3 to which second station of RIO1 are set, parameter set #3 which is the latter will be displayed as the alarm.

(c) A PLC device outside the assignable range has been set to the RIO assignment parameter.

(d) 25 or more stations have been specified with the high-speed input or output with the RIO assignment parameters.

(e) The RIO assignment parameters have not been specified to the remote I/O unit stations with DI/DO functions (except safety DI/DO) that are connected to NC.

(f) Two or more stations of the PLC devices are set redundantly to the RIO assignment parameters.

Note

(1) However, these (a) to (f) will not be issued with the alarm "Y05 Initial parameter error" in the following cases:

- "0" has been set to the target channel.
- Remote I/O unit with DI/DO function is not connected to the station specified with the target channel and station number.
- The parameter "#1238 set10/bit3" is ON (the input from RIO is ignored).

(Example) The power is turned ON in a state where the X100 and X200 of the PLC device are set redundantly to the RIO assignment parameters #1 to #5 as shown in the table below.

(All stations which has been set to the RIO assignment parameters #1 to #5 are connected to the NC control unit.)

Parameter set No.#n	DI device name #N (Parameter No.)	DI device No. #N (Parameter No.)	Setting state
1	X (#53013)	100 (#53014)	X100 is set
2	X (#53023)	200 (#53024)	X200 is set
3	X (#53033)	200 (#53034)	X200 is set
4	X (#53043)	100 (#53044)	X100 is set
5	X (#53053)	100 (#53054)	X100 is set

<Result>

The parameter number (53034) of "DI device No. #3" will be displayed on the alarm "Y05 Initial parameter error".

Duplication error of X200 will be detected first because the RIO assignment parameter is checked from the top. Between the parameter set #2 and #3 to which the X200 are set, parameter set #3 which is the latter will be displayed as the alarm.

Operating parameter setting screen**[Rules for setting RIO assignment parameters]**

- For arbitrary device assignment, assign PLC devices to all stations which are connected to the remote units with DI/DO function. Devices can be assigned in random order for arbitrary device assignment. It is unnecessary to assign in order of the target channels, target station numbers, PLC devices, etc.
- Set the PLC device numbers after setting the PLC device names.
A setting error occurs if PLC number is input when the PLC device name is in the unset (blank) state. When a PLC device name is changed, PLC device number of the same parameter set number is cleared to zero.
- When setting the bit devices, set the DI and DO device numbers in increments of 32 points. A setting error occurs if device number is not a multiple of 32 (20 for hexadecimal).
- When setting the word devices, set the DI and DO device numbers in increments of two words (32 bits).
A setting error occurs if the device number is odd.
- Set the target channels to "0" for the parameter sets which are not set for device assignment. The setting state of the parameter sets to which "0" has been set for the target channel will not be checked.
- The RIO assignment parameter setting values are retained even when the fixed device assignment and arbitrary device assignment are switched.

[RIO assignment parameter setting state check ("Device Setting Check")]

- The RIO assignment parameter setting state can be checked without rebooting the power by setting the RIO assignment parameter "Device Setting Check" to "1" when performing the arbitrary device assignment.
The RIO assignment parameter setting state will not be checked at the fixed device assignment.
- The RIO assignment parameter settings cannot be valid only by inputting "1" to "Device Setting Check". To enable the arbitrary device assignment, turn the power OFF and ON after the RIO assignment parameter settings.
- The value of "Device Setting Check" goes back to "0" after the check for the RIO parameter setting state is completed.
- The RIO assignment parameter setting state of each remote I/O unit station with the analog input/output and safety DI/DO functions will not be checked.
- The setting state of the parameter set which has been set as the station unconnected to the NC control unit will not be checked.
- The setting state of the parameter sets of which the target channel number has been set to "0" will not be checked.

2.2.3 Relation of Connector Pins and Device

(1) Input (DI) signal

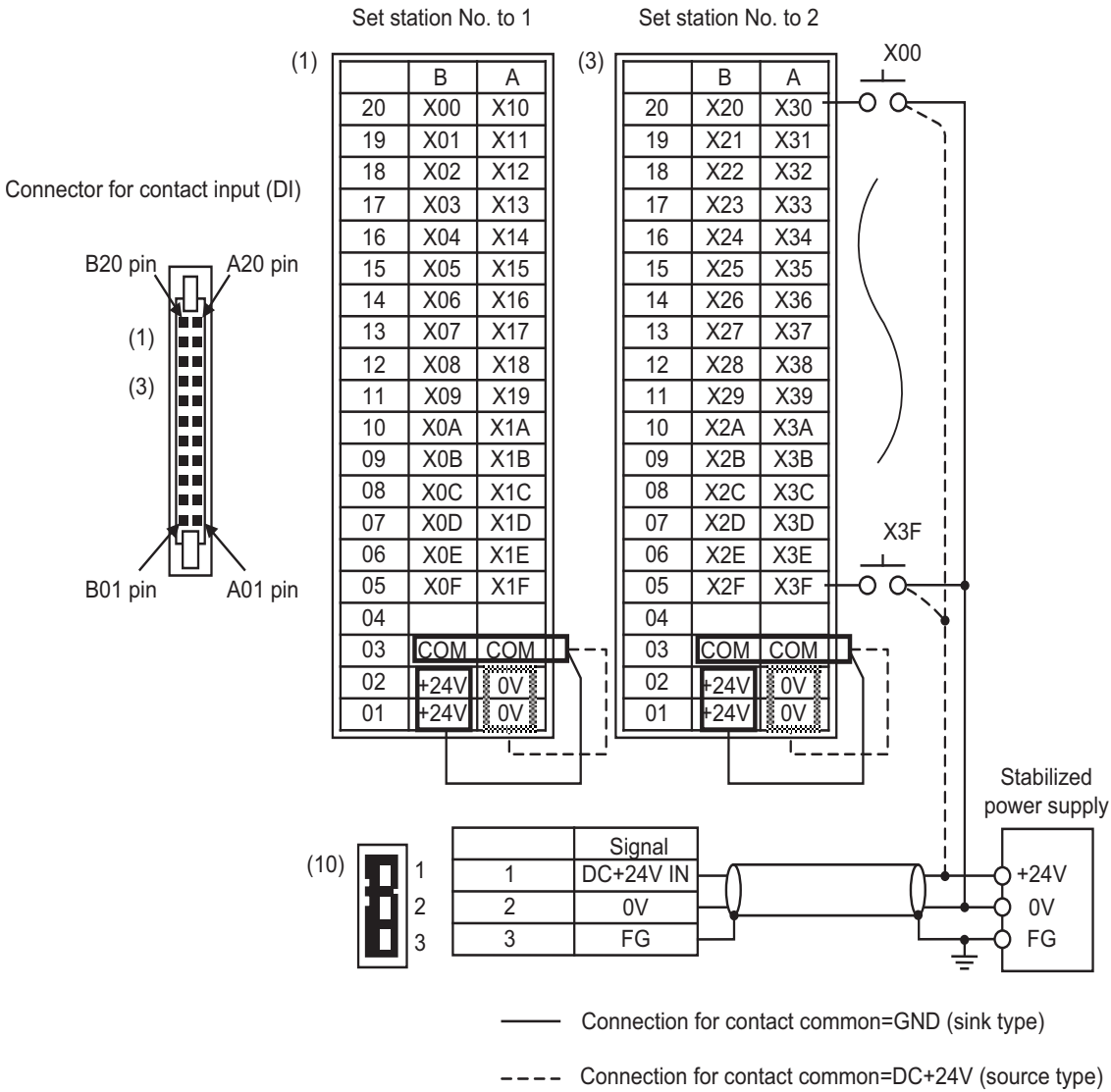

Note

- The No. of points (devices) will differ according to the RIO unit type.
- The devices shown here show an example for when the station No. of RIO unit is set to "1" and set to "2".

(2) Output (DO) signal

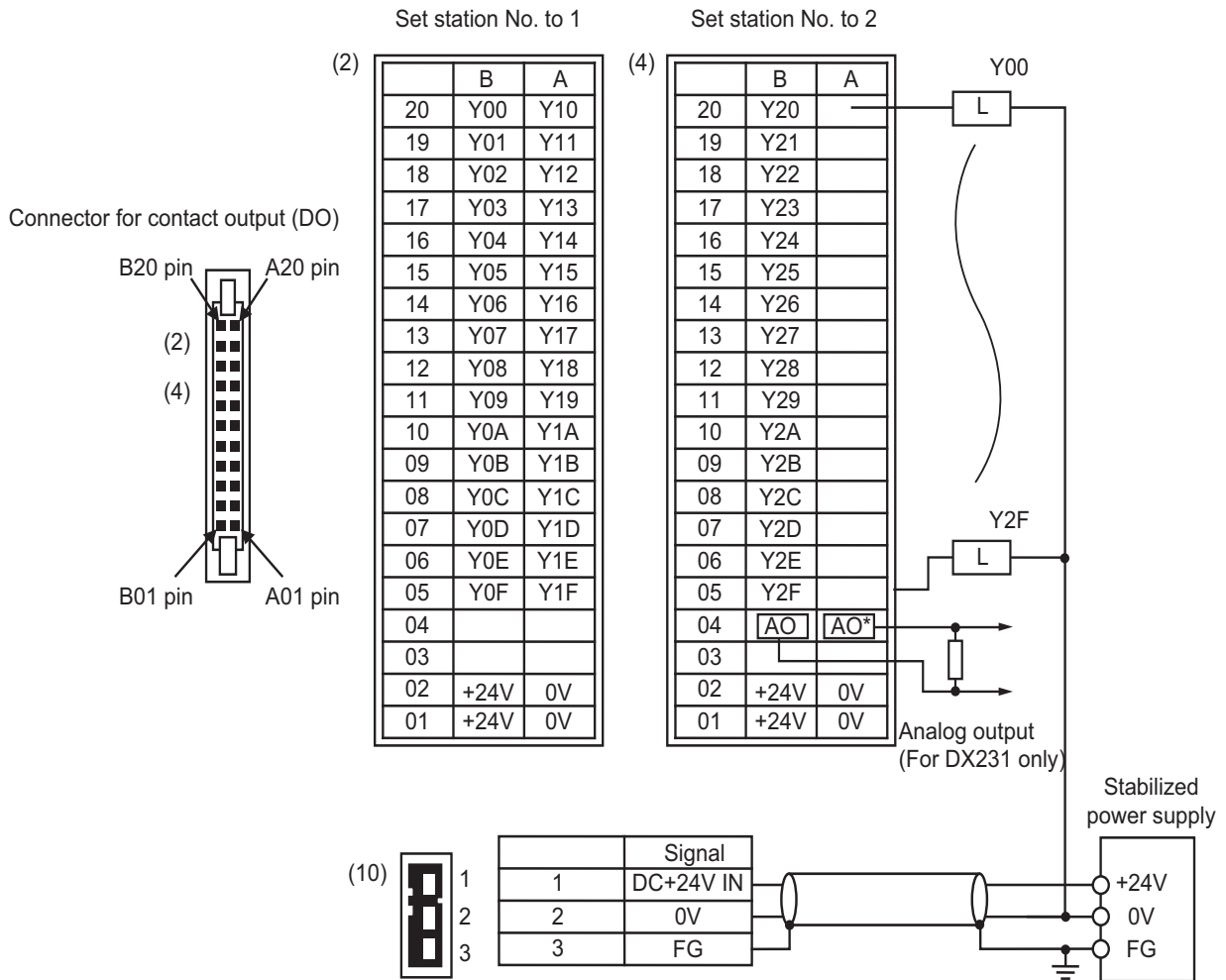

Note

- The No. of points (devices) will differ according to the RIO unit type.
- The devices shown here show an example for when the station No. of RIO unit is set to "1" and set to "2".
- The A04 and B04 pin analog output (AO, AO*) in the output connector (4) is found only on the RIO unit DX231. Refer to the section "2.7 Outline of Analog Signal Input Circuit" for details on DX220/DX230 connector.

2.2.4 Setting Example When Connecting Directly to the Control Unit

■ For fixed device assignment

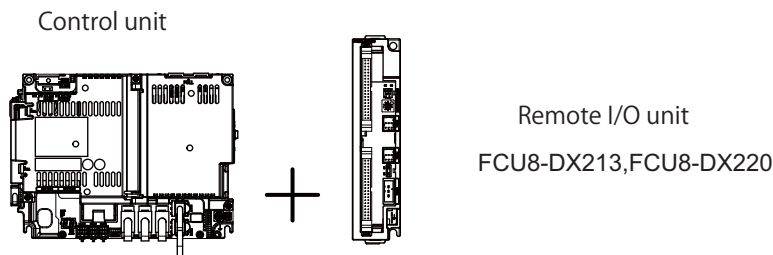

[When connecting to RIO 1]

Rotary switch setting				
		0	1		7	8		F
Group 1 1: OFF 2: OFF	Station No.	1	2	...	8	9	...	16
	Input device	X0000 to X001F	X0020 to X003F	...	X00E0 to X00FF	ZR5000 to ZR5001	...	ZR5014 to ZR5015
	Output device	Y0000 to Y001F	Y0020 to Y003F	...	Y00E0 to Y00FF	ZR6000 to ZR6001	...	ZR6014 to ZR6015
Group 2 1: OFF 2: ON	Station No.	17	32
	Input device	ZR5016 to ZR5017	ZR5046 to ZR5047
	Output device	ZR6016 to ZR6017	ZR6046 to ZR6047

[When connecting to RIO 2]

Rotary switch setting				
		0	1		7	8		F
Group 1 1: OFF 2: OFF	Station No.	1	2	...	8	9	...	16
	Input device	X0100 to X011F	X0120 to X013F	...	X01E0 to X01FF	ZR5200 to ZR5201	...	ZR5214 to ZR5215
	Output device	Y0100 to Y011F	Y0120 to Y013F	...	Y01E0 to Y01FF	ZR6200 to ZR6201	...	ZR6214 to ZR6215
Group 2 1: OFF 2: ON	Station No.	17	32
	Input device	ZR5216 to ZR5217	ZR5246 to ZR5247
	Output device	ZR6216 to ZR6217	ZR6246 to ZR6247

2.3 Fixed Signals

The connector pin Nos. in the input signals that are fixed are shown below.

Note that using the methods below can ignore fixed signals and change the allocations.

Signal name	Device	Signal name	Device
Emergency stop	EMG of main unit	Stroke end -1	X20
Stroke end +1	X28	Stroke end -2	X21
Stroke end +2	X29	Stroke end -3	X22
Stroke end +3	X2A	Stroke end -4	X23
Stroke end +4	X2B	Stroke end -5	X64
Stroke end +5	X6C	Stroke end -6	X65
Stroke end +6	X6D	Stroke end -7	X66
Stroke end +7	X6E	Stroke end -8	X67
Stroke end +8	X6F		
Reference position return near point de- tection 1	X18		
Reference position return near point de- tection 2	X19		
Reference position return near-point de- tection 3	X1A		
Reference position return near point de- tection 4	X1B		
Reference position return near point de- tection 5	X5C		
Reference position return near point de- tection 6	X5D		
Reference position return near point de- tection 7	X5E		
Reference position return near point de- tection 8	X5F		

Note

- (1) When using the multi-part system and the 1st part system has 2 axes and the 2nd part system has 1 axis, the 1st axis in the 2nd part system will correspond to the 3rd axis above.

2.3.1 Ignoring Fixed Signals

The fixed signals can be used as other signals by ignoring them with file registers R248 and R272.

2.3.2 Changing the Addresses of Fixed Signals

The fixed devices can be allocated arbitrarily with the following parameters.

The parameters #2073 to #2075 are valid when "#1226 aux10/bit 5" is set to "1".

When the parameters #2073 to #2075 are valid, do not set the same device number.

If the same device number exists, an emergency stop occurs. However, no device number check is performed for an axis to which a signal (R248, R272) that ignores the fixed signal is input.

When the arbitrary allocation is valid, the fixed signals can be used as other signals.

#	Items	Description	Setting range
1226	aux10(bit5)	Arbitrary allocation of dog signal Specify whether to enable the arbitrary allocation parameter for the origin dog and H/W OT. 0: Disable arbitrary allocation. (Fixed device) 1: Enable arbitrary allocation. (Device specified by the parameter)	0/1
2073	zrn_dog	Origin dog Under the standard specifications, the origin dog signal is assigned to a fixed device. When it is desired to assign the origin dog signal to a position other than the fixed device, specify the input device in this parameter. ♦ This parameter is enabled in the following conditions. NC axis: When "#1226 aux10/bit5" is set to "1". PLC axis: When "#1246 set18/bit7" is set to "1". ♦ When this parameter is valid, do not set the same device number. If the same device number exists, an emergency stop occurs. However, no device number check is performed for an axis to which a signal that ignores the near-point dog signal (R272) is input.	0000 to 02FF (HEX)
2074	H/W_OT+	H/W OT+ Under the standard specifications, the OT (+) signal is assigned to a fixed device. When it is desired to assign the OT (+) signal to a position other than the fixed device, specify the input device in this parameter. ♦ This parameter is enabled in the following conditions. NC axis: When "#1226 aux10/bit5" is set to "1". PLC axis: When "#1246 set18/bit7" is set to "1". ♦ When this parameter is valid, do not set the same device number. If the same device number exists, an emergency stop occurs. However, no device number check is performed for an axis to which a signal that ignores the OT signal (R248) is input.	0000 to 02FF (HEX)
2075	H/W_OT-	H/W OT- Under the standard specifications, the OT (-) signal is assigned to a fixed device. When it is desired to assign the OT (-) signal to a position other than the fixed device, specify the input device in this parameter. ♦ This parameter is enabled in the following conditions. NC axis: When "#1226 aux10/bit5" is set to "1". PLC axis: When "#1246 set18/bit7" is set to "1". ♦ When this parameter is valid, do not set the same device number. If the same device number exists, an emergency stop occurs. However, no device number check is performed for an axis to which a signal that ignores the OT signal (R248) is input.	0000 to 02FF (HEX)

2.4 PLC I/F Axis Random Device Assignment

PLC I/F axis random device assignment (hereinafter referred to as random device assignment) function assigns the PLC input/output signals (CNC control and CNC status signals) of each axis to any desired axes. Using the random device assignment parameter allows you to reduce the change in ladder when you use a ladder programmed for a different axis configuration system.

The PLC input/output signals for 32 axes are available (8 axes per part system x 4 part systems).

For the system which has 5 or more part systems or 9 axes in the part system, the setting of "#1603 PLCdev_no" is required.

■ (Example) When a ladder for the system with 5 axes in the part system is used for the said system from which the 4th axis is deleted

When you use a ladder in the axis configuration that is different from that for which the ladder was originally programmed, the device Nos. in the ladder need to be corrected; however, you can use the ladder for 5-axis control almost as is simply by assigning the 5th device No. to the 4th axis.

[Setting parameter of device assignment function]

Axis number	1	2	3	4	5	6	7	8	9
#1603 PLCdev_no	1	2	3	5	9	10	11	12	13

Axis number	\$1	\$2	\$3	\$4
1	PC01	PC09	PC17	PC25
2	PC02	PC10	PC18	PC26
3	PC03	PC11	PC19	PC27
4	PC04	PC12	PC20	PC28
5	PC05	PC13	PC21	PC29
6	PC06	PC14	PC22	PC30
7	PC07	PC15	PC23	PC31
8	PC08	PC16	PC24	PC32

Axis number	\$1	\$2	\$3	\$4
1	PC01	PC09		
2	PC02	PC10		
3	PC03	PC11		
4	PC05	PC12		
5		PC13		
6				
7				
8				

[Fixed device assignment of PLC input/output signal]

[PLC input/output signal after device assignment]

(PC** indicates the device number of PLC input/output signal.)

2 System Configuration of H/W

2.4 PLC I/F Axis Random Device Assignment

2.4.1 Function Enabling Conditions

■ When enabling device assignment

Set the device numbers (1 to 32) to assign to each axis of the parameter "#1603 PLCdev_no". Even when the assignment is not changed as the 1st to 3rd axes in the table below, the setting is required for all valid axes.

[Setting parameter of device assignment function]

Axis number	1	2	3	4	5	6	7	8	9
#1603 PLCdev_no	1	2	3	5	9	10	11	12	13

■ When disabling device assignment

Set the parameter "#1603 PLCdev_no" of all axes to an invalid value (0).

2.4.2 Random Assignment of Bit-type Device

For bit-type PLC input/output signals, random device assignment is performed as follows:

■ (Example) Servo OFF (Y7A0 to Y7BF)

[Setting example of random device assignment parameter]

Axis number	1	2	3	4	5	6	7	8	9
#1603 PLCdev_no	1	2	3	5	9	10	11	4	13

Axis number	\$1	\$2	\$3	\$4
1	Y7A0	Y7A8	Y7B0	Y7B8
2	Y7A1	Y7A9	Y7B1	Y7B9
3	Y7A2	Y7AA	Y7B2	Y7BA
4	Y7A3	Y7AB	Y7B3	Y7BB
5	Y7A4	Y7AC	Y7B4	Y7BC
6	Y7A5	Y7AD	Y7B5	Y7BD
7	Y7A6	Y7AE	Y7B6	Y7BE
8	Y7A7	Y7AF	Y7B7	Y7BF

Axis number	\$1	\$2	\$3	\$4
1	Y7A0	Y7A8		
2	Y7A1	Y7A9		
3	Y7A2	Y7AA		
4	Y7A4	Y7A3		
5		Y7AC		
6				
7				
8				

[Fixed device assignment of servo OFF signal]

[Random device assignment example of Servo OFF signal]

2.4.3 Example Usage

The following is an example of random device assignment for the axis configuration with 2 part systems from which Y axis is removed.

[Example of axis configuration before change]

Axis number	1	2	3	4	5
Axis names of the 1st part system	X1	Z1	C1	Y1	B1
Axis names of the 2nd part system	X2	Z2	C2	Y2	B2

[Example of axis configuration after change]

Axis number	1	2	3	4	5
Axis names of the 1st part system	X1	Z1	C1	B1	
Axis names of the 2nd part system	X2	Z2	C2	B2	

[Random device assignment setting before change (the same settings as when axis configuration is invalid)]

Axis number	1	2	3	4	5	6	7	8	9	10
#1013 axname	X1	Z1	C1	Y1	B1	X2	Z2	C2	Y2	B2
#1603 PLCdev_no	1	2	3	4	5	9	10	11	12	13

Set the parameters as follows:

- (1) Set the 4th axis of "#1603 PLCdev_no" to "5" because B1 axis is changed from the 5th axis to the 4th axis.
- (2) Set the 5th to 7th axes of "#1603 PLCdev_no" to "9" to "11" because the part system-common axis numbers of X2, Z2 and C2 axes are shifted.
- (3) Set the 8th axis of "#1603 PLCdev_no" to "13" because B2 axis is changed from the 10th axis to the 8th axis.
- (4) Also set X1, Z1 and C1 axes of "#1603 PLCdev_no" although their axis numbers are unchanged, because assignment is required for all axes.

[Setting example of random device assignment after change]

Axis number	1	2	3		4	5	6	7		8
#1013 axname	X1	Z1	C1		B1	X2	Z2	C2		B2
#1603 PLCdev_no	1	2	3		5	9	10	11		13

2.5 Outline of Digital Signal Input Circuit

Both 24 V common and 0 V common connections are allowed in the digital signal input circuit. Follow the wiring diagram below for each type.

Input circuit

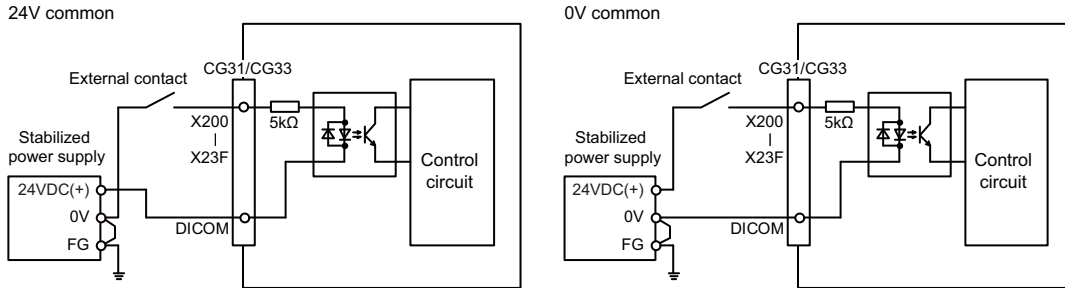

Input conditions

The input signals must be used within the following condition ranges.

		24 V common	0 V common
1	Input voltage at external contact ON	6 V or less	18 V or more, 25.2 V or less
2	Input current at external contact ON	3 mA or more	
3	Input voltage at external contact OFF	20.2 V or more, 25.2 V or less	3.8V or less
4	Input current at external contact OFF	0.7 mA or less	
5	Input resistance	5 kΩ	
6	Tolerable chattering time (T1)	3 ms	
7	Input signal holding time (T2)	40 ms or more(*1)	
8	input circuit operation delay time (T3 and T4)	3 ms to 16 ms	
9	Machine side contact capacity	30 V or more, 16 mA or more	

(*1) Input signal holding time: The guide is 40 ms or more. The input signal is recognized only when its "ON" state is held longer than the ladder processing cycle time.

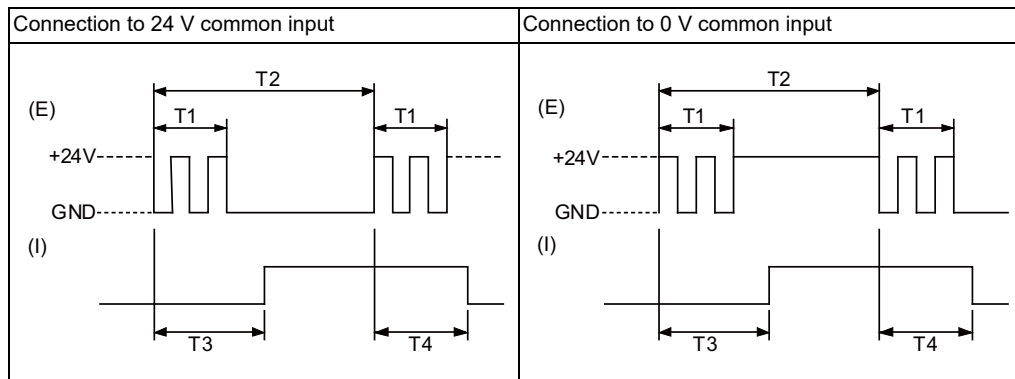

(E): External signal

(I): Internal signal

2.6 Outline of Digital Signal Output Circuit

Use within the specification ranges shown below.

■ Output circuit

[FCU8-DX830 / FCU8-DX837]

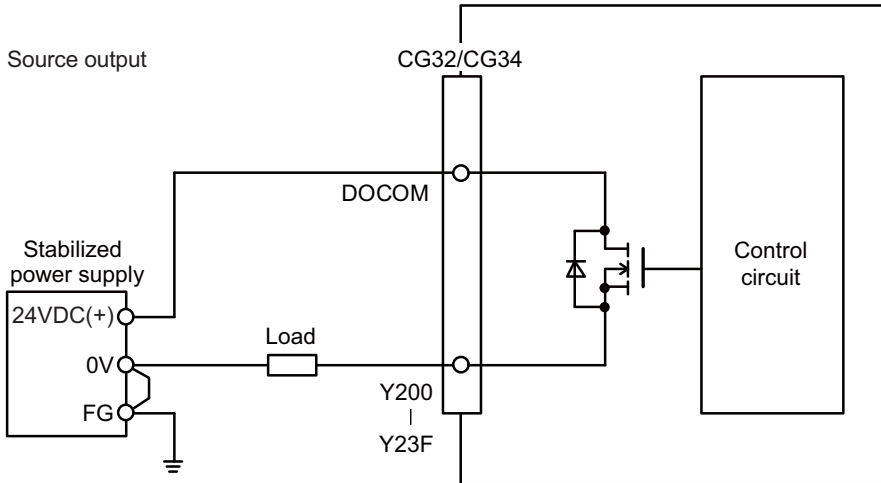

[FCU8-DX834]

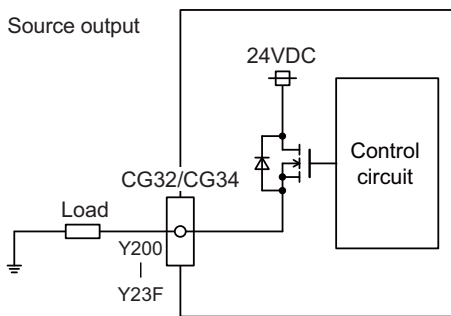

■ Output conditions

Insulation method	Non-insulation
Rated load voltage	24VDC
Max. output current	0.2 A/point 3.8 A or less in the unit
Output delay time	40 μ s

2 System Configuration of H/W

2.6 Outline of Digital Signal Output Circuit

Note

- (1) When using an inductive load such as a relay, always connect a diode (voltage resistance 100V or more, twice or more the load current) in parallel to the load.

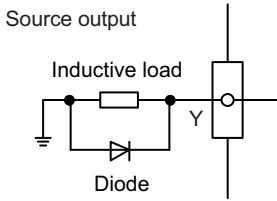

- (2) When the rush current exceeds the maximum output current, always connect a protective resistor serially to the load to suppress rush currents. Make sure that the current is less than the maximum output current including the momentary current.

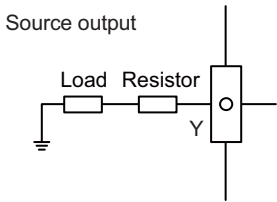

- (3) Always keep the total sum of output current of each Y200 to Y207, Y208 to Y20F, Y210 to Y217, Y218 to Y21F, Y220 to Y227, Y228 to Y22F, Y230 to Y237 and Y238 to Y23F less than 0.8 A.

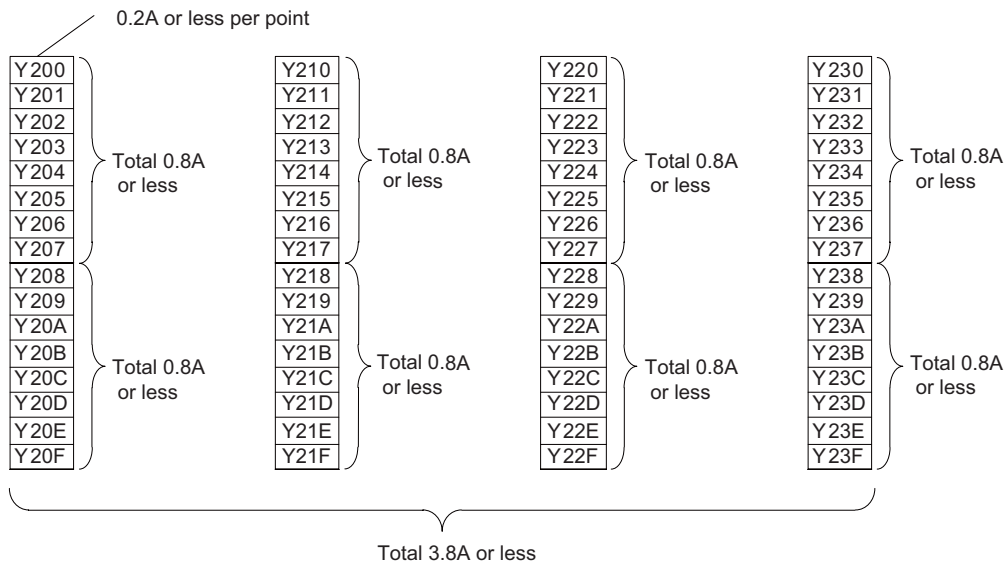

CAUTION

- (1) When using an inductive load such as a relay, always connect a diode in parallel to the load to prevent a counter-electromotive force.
- (2) When the rush current exceeds the maximum output current, always connect a protective resistor serially to the load to suppress rush currents.

2.7 Outline of Analog Signal Input Circuit

■ Input circuit

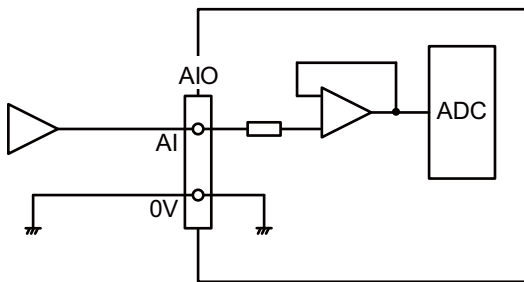

■ Input conditions

Analog input voltage	-10 V to 10 V
Max. input rating (*1)	±15 V
Resolution	$ -10 \text{ V to } +10 \text{ V} / 4095 = 4.88 \text{ mV}$
Repeatability	Within ±25 mV (*2)
Tolerance	±0.35 V

(*1) This indicates the input voltage which must not exceed even in an instant.

(*2) Except when the accuracy is affected by the noise.

2.8 Outline of Analog Signal Output Circuit

■ Output circuit

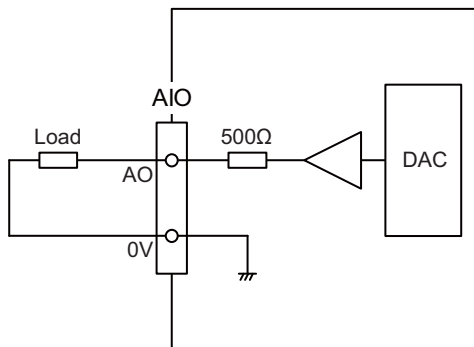

■ Output conditions

Analog output voltage	-10 V to 10 V ($\pm 5\%$)
Resolution	$10 \text{ V} / 4095 = 2.44 \text{ mV}$
Load conditions	10 k Ω load resistance
Output resistance value	500 Ω

2.9 Outline of I/O Assignment with PROFIBUS-DP

By installing the PROFIBUS-DP unit FCU8-EX563 and connecting the slave stations compatible with PROFIBUS-DP communication to M8V Series expansion slot, NC can input/output the devices to/from the slave stations as the master station for PROFIBUS-DP communication. However, it is not possible to use the NC with two units of FCU8-EX563 installed at a time. If two units of FCU8-EX563 are installed at a time, both units stop their operation and the error occurs.

Hilscher's Fieldbus communication control unit (COM module) is mounted on FCU8-EX563, and parameters are set using Hilscher configurator "SYCON.net". Up to 125 slave stations can be connected.

Inputs/outputs of the devices from NC's PLC are all handled as bit device data. Up to 512 points can be input/output.

Maximum number of inputs/outputs for NC remote I/O unit is 768, whether or not FCU8-EX563 is installed.

[PROFIBUS-DP connection outline (M800VW)]

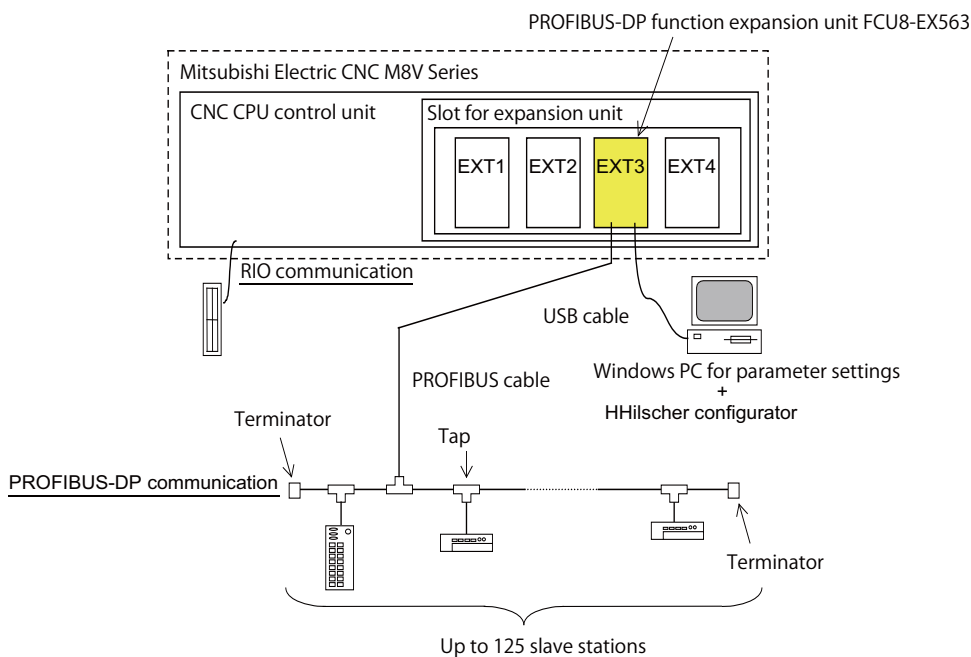

[Machine input/output signal allocation]

Input/output device allocation when FCU8-EX563 is mounted is as shown below.

	RIO communication only			With PROFIBUS-DP communication			
	RIO1	RIO2	RIO3	RIO1	RIO2	RIO3	PROFIBUS-DP communication
Input	X00 to XFF	X100 to X1FF	X200 to X2FF	X00 to XFF	X100 to X1FF	X200 to X2FF	X400 to X5FF
Output	Y00 to YFF	Y100 to Y1FF	Y200 to Y2FF	Y00 to YFF	Y100 to Y1FF	Y200 to Y2FF	Y400 to Y5FF

2.10 Flow of Signals

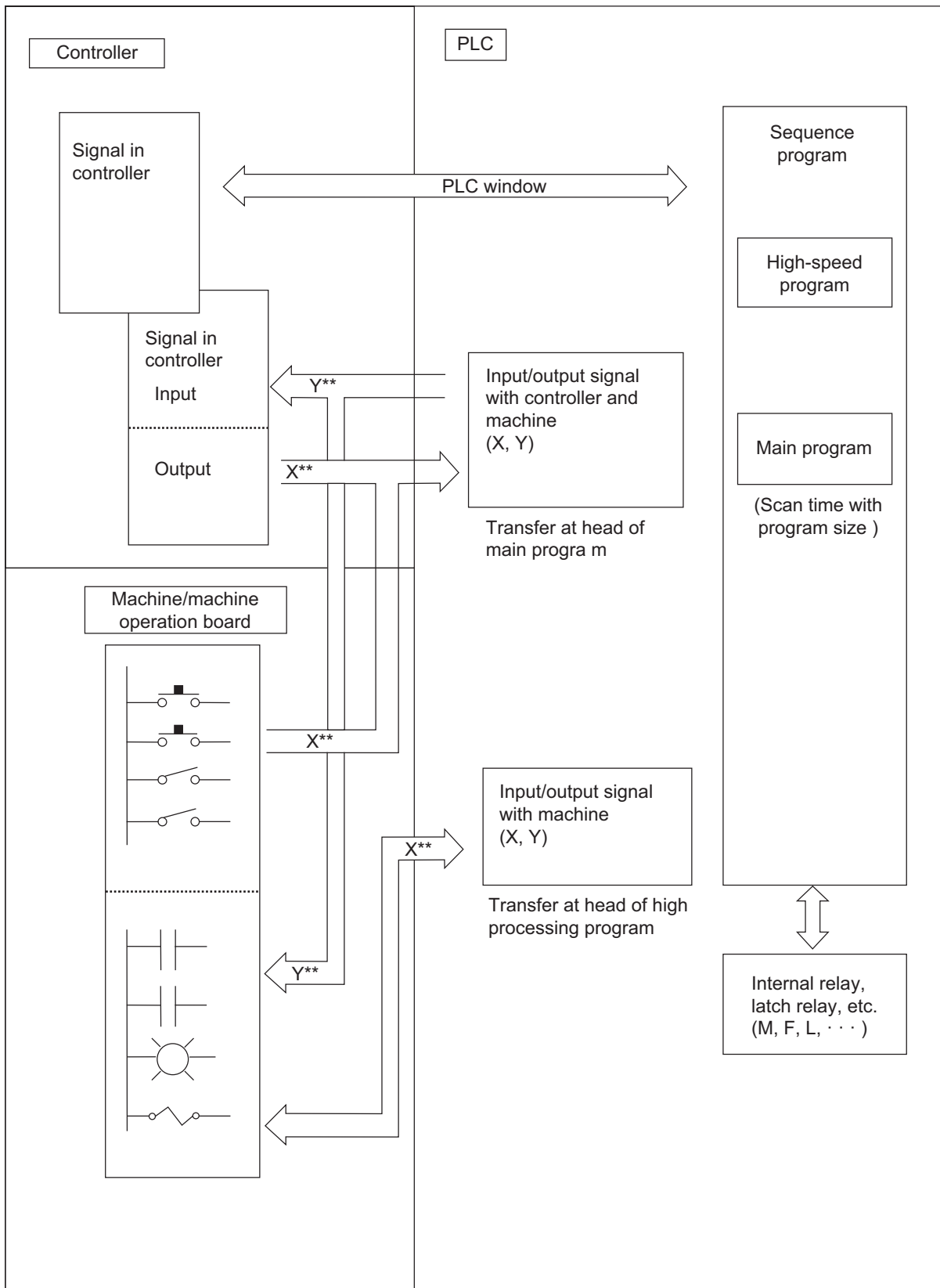

2.11 List of Devices

The device range in the following table is the default number of device points set in the project 1 when the multi-project setting or the setting of the number of device points is not performed.

Device	Device No.	Unit	Details
X (*1)	X0 to X1FFF (8192 points)	1 bit	Input signal to PLC: Machine input, etc.
Y (*1)	Y0 to Y1FFF (8192 points)	1 bit	Output signal from PLC: Machine output, etc.
M	M0 to M61439 (61440 points)	1 bit	Temporary memory
F	F0 to F2047 (2048 points)	1 bit	Temporary memory, alarm message interface
L	L0 to L1023 (1024 points)	1 bit	Latch relay (back up memory)
SM	SM0 to SM2047 (2048 points)	1 bit	Special relay
V	V0 to V511 (512 points)	1 bit	Edge relay
SB	SB0 to SB3FF (1024 points)	1 bit	Special relay
B	B0 to BDFFF (57344 points)	1 bit	Link relay
SW	SW0 to SW3FF (1024 points)	16 bits	Special register
SD	SD0 to SD2047 (2048 points)	16 bits	Special register
T	T0 to T2047 (2048 points)	1 bit/16 bits	Timer (The variable/fixed boundary is set with a parameter.) (*2)
ST	ST0 to ST127 (128 points)	1 bit/16 bits	Integrated timer (100 ms unit)
C	C0 to C511 (512 points)	1 bit/16 bits	Counter (The variable/fixed boundary is set with a parameter.)
D	D0 to D4095 (4096 points)	16 bits/32 bits	Data register (Register for calculation)
R (*1)	R0 to R32767 (32768 points)	16 bits/32 bits	File register, CNC word interface
ZR (*1)	ZR0 to ZR13311 (13312 points)	16 bits/32 bits	File register (Input/output signals with the PLC, machine input/output, etc.)
W	W0 to W2FFF (12288 points)	16 bits/32 bits	Link register
Z (*3)	Z0 to Z13/Z0 to Z9 (14 points/10 points)	16 bits	Address index
N	N0 to N7 (8 points)		Master controller nesting level
P (*1)	P0 to P4095 (4096 points)		Label for conditional jump, subroutine call command (*4)
K	K-32768 to K32767		Decimal constant for 16-bit command
	K-2147483648 to K2147483647		Decimal constant for 32-bit command
H	H0 to HFFFF		Hexadecimal constant for 16-bit command
	H0 to HFFFFFFFF		Hexadecimal constant for 32-bit command
E	E±1.17549435-38 to E±3.40282347+38		Hexadecimal constant for 16-bit command
	E±2.2250738585072014 - 308 to E±1.7976931348623157+308		Hexadecimal constant for 32-bit command
\$	0 to 32 characters		String constant

(*1) These devices have designated applications. Do not use devices other than those corresponding to the input/output signals with the machine side (input/output signals of the remote I/O unit), even if it is an undefined vacant device.

(*2) Distinction of 10 ms timer and 100 ms timer is performed by command.

(10 ms timer is performed by OUTH command, 100 ms timer is performed by OUT command.)

(*3) For the Z device, the number of device points depends on the parameter setting.

(*4) The P device has two types of pointers (local and common), and the above points are the total points.

2.11.1 Device Range Setting at Multi-project

Each device will be categorized to either the common device among projects (common device among projects) or the independent device for each projects (independent device among projects) when the multi-project function is used.

■ Common device among projects

Device is influenced by the access from the multiple projects.

The number of device points is fixed without being affected by the number of projects.

For example, the X/Y/R devices are common devices among projects.

■ Independent device among projects

Device can be used independently in the multiple projects.

In addition, Independent device among projects are categorized into variable points or fixed points device.

[Independent device among projects (fixed points)]

The number of device points is fixed without being affected by the number of projects.

For example, the SM/SD/Z devices are independent devices among projects (fixed points).

[Independent device among projects (variable points)]

The maximum number of project is allocated to each project and used.

For example, the M/L/SB devices are independent devices among projects (variable points).

2 System Configuration of H/W

2.11 List of Devices

The list of device categories is as follows.

[Category explanation]

Category	Details
Common	Common device among projects
Independent (fixed)	Independent device among projects (fixed points)
Independent (variable)	Independent device among projects (variable points)
Common/independent	Independent device among projects (variable points) However, it is possible to set as the common device among projects from the top.

[List of categories]

Device	Category	Number of devices (Maximum number of projects)
X	Common	8192 point
Y	Common	8192 point
M	Common/independent	61440 points (122880 points)
L	Independent (Variable)	1024 points (2048 points)
F	Common	2048 point
SB	Independent (Variable)	1024 points (2048 points)
B	Independent (Variable)	57344 points (114688 points)
SM	Independent (Fixed)	2048 point
V	Independent (Variable)	256 points (1024 points)
SW	Independent (Variable)	1024 points (2048 points)
SD	Independent (Fixed)	2048 point
T	Independent (Variable)	2048 points (4096 points)
ST	Independent (Variable)	128 points (256 points)
C	Independent (Variable)	512 points (1024 points)
D	Common/independent	4096 points (8192 points)
R	Common	32768 point
ZR	Common	13312 point
W	Independent (Variable)	12288 points (24576 points)
Z	Independent (Fixed)	14 points/10 points
N	Independent (Fixed)	15 point
P	Independent (Fixed)	4096 point

- When the additional specification of "Number of PLC projects: 6" is valid, the number of device points in "()" (parentheses) becomes valid.
- The number of device points of the Z device varies depending on the parameter setting.

Refer to "PLC Programming Manual" for details on the independent device among projects and the common device among projects.

2.12 File Register General Map

Device	Details
R00000 to R00199	System common data (NC -> PLC)
R00200 to R00499	System common data (PLC -> NC)
R00500 to R00699	1st part system data (NC -> PLC)
R00700 to R00899	2nd part system data (NC -> PLC)
R00900 to R01099	3rd part system data (NC -> PLC)
R01100 to R01299	4th part system data (NC -> PLC)
R01300 to R01499	5th part system data (NC -> PLC)
R01500 to R01699	6th part system data (NC -> PLC)
R01700 to R01899	7th part system data (NC -> PLC)
R01900 to R02099	8th part system data (NC -> PLC)
R02100 to R02397	Pallet program data (Drive unit -> PLC)
R02398 to R20499	System reserve
R02500 to R02699	1st part system data (PLC -> NC)
R02700 to R02899	2nd part system data (PLC -> NC)
R02900 to R03099	3rd part system data (PLC -> NC)
R03100 to R03299	4th part system data (PLC -> NC)
R03300 to R03499	5th part system data (PLC -> NC)
R03500 to R03699	6th part system data (PLC -> NC)
R03700 to R03899	7th part system data (PLC -> NC)
R03900 to R04099	8th part system data (PLC -> NC)
R04100 to R04103	Pallet program data (PLC -> Drive unit)
R04104 to R04499	System reserve
R04500 to R05683	Axis data (NC -> PLC)
R05684 to R05699	System reserve
R05700 to R06371	Axis data (PLC -> NC)
R06372 to R06499	User macro (NC -> PLC: 64 point, PLC -> NC: 64 point)
R06500 to R06549	1st spindle data (NC -> PLC)
R06550 to R06599	2nd spindle data (NC -> PLC)
R06600 to R06649	3rd spindle data (NC -> PLC)
R06650 to R06699	4th spindle data (NC -> PLC)
R06700 to R06749	5th spindle data (NC -> PLC)
R06750 to R06799	6th spindle data (NC -> PLC)
R06800 to R06849	7th spindle data (NC -> PLC)
R06850 to R06899	8th spindle data (NC -> PLC)
R06900 to R06999	System reserve
R07000 to R07049	1st spindle data (PLC -> NC)
R07050 to R07099	2nd spindle data (PLC -> NC)
R07100 to R07149	3rd spindle data (PLC -> NC)
R07150 to R07199	4th spindle data (PLC -> NC)
R07200 to R07249	5th spindle data (PLC -> NC)
R07250 to R07299	6th spindle data (PLC -> NC)
R07300 to R07349	7th spindle data (PLC -> NC)
R07350 to R07399	8th spindle data (PLC -> NC)
R07400 to R07499	System reserve
R07500 to R07949	PLC constants
R07950 to R07999	System reserve
R08000 to R08099	PLC axis indexing
R08100 to R08259	System reserve
R08260 to R08289	Option status export to PLC
R08290 to R08299	Optimum acceleration/deceleration (Spindle)
R08300 to R09799	User backed up area
R09800 to R09899	User work area

2 System Configuration of H/W

2.12 File Register General Map

Device	Details
R10000 to R10099	Remote I/O communication error information
R10181 to R10187	System reserve
R10188 to R10189	Base PLC mounting check
R10600 to R12759	ATC data, tool life management for M system/Tool life management I, II for L system
R12760 to R13999	System reserve
R14000 to R14499	EcoMonitorLight data (NC -> PLC)
R14500 to R14699	MES Interface (System common data)
R14700 to R14949	MES Interface (1st part system data) (PLC -> NC)
R14950 to R15199	MES Interface (2nd part system data) (PLC -> NC)
R15200 to R15449	MES Interface (3rd part system data) (PLC -> NC)
R15450 to R15699	MES Interface (4th part system data) (PLC -> NC)
R15700 to R15949	MES Interface (5th part system data) (PLC -> NC)
R15950 to R16199	MES Interface (6th part system data) (PLC -> NC)
R16200 to R16449	MES Interface (7th part system data) (PLC -> NC)
R16450 to R16699	MES Interface (8th part system data) (PLC -> NC)
R16700 to R17299	System reserve
R17300 to R18299	Modbus input/output device
R18300 to R19799	User backed up area
R19800 to R19899	User work area
R19900 to R19999	System reserve
R20000 to R20199	System common data (NC -> PLC)
R20200 to R20499	System common data (PLC -> NC)
R20500 to R20699	1st part system data (NC -> PLC)
R20700 to R20899	2nd part system data (NC -> PLC)
R20900 to R21099	3rd part system data (NC -> PLC)
R21100 to R21299	4th part system data (NC -> PLC)
R21300 to R21499	5th part system data (NC -> PLC)
R21500 to R21699	6th part system data (NC -> PLC)
R21700 to R21899	7th part system data (NC -> PLC)
R21900 to R22099	8th part system data (NC -> PLC)
R22100 to R22499	System reserve
R22500 to R22699	1st part system data (PLC -> NC)
R22700 to R22899	2nd part system data (PLC -> NC)
R22900 to R23099	3rd part system data (PLC -> NC)
R23100 to R23299	4th part system data (PLC -> NC)
R23300 to R23499	5th part system data (PLC -> NC)
R23500 to R23699	6th part system data (PLC -> NC)
R23700 to R23899	7th part system data (PLC -> NC)
R23900 to R24099	8th part system data (PLC -> NC)
R24100 to R24499	System reserve
R24500 to R25683	Axis data (NC -> PLC)
R25684 to R26371	Axis data (PLC -> NC)
R26372 to R27499	System reserve
R27500 to R28299	PLC constants (prepared for specific machine tool builders)
R28300 to R29799	User backed up area
R29800 to R29899	User work area
R29900 to R32767	System reserve

Note

(1) Do not use the system reserve as it is used by Mitsubishi Electric for function expansion.

Input/Output Signals with Machine

Classification of Machine Input/Output Signals

The signals handled by the PLC are classified as shown below.

When designing, refer to the section indicated below and make allocations according to the table in the respective section.

	Signal type		Explanation	Reference
Input	DI	Machine	<ul style="list-style-type: none"> Allocated to device X. Some connector pin allocations are determined. <ul style="list-style-type: none"> Stroke end signal (+, -) Reference point return near-point detection signal The high-speed processing input is set with the parameters. (Read in at the head of the high-speed processing scan.) 	3.1.1 Input Signals from Machine
		PLC Switch Input(*1)	<ul style="list-style-type: none"> The switches can be substituted by the setting and display unit. Allocated to device X. The switch names displayed on the setting and display unit are user release switches. The names can be created with the ladder message creation. 	3.1.2 PLC Switch/Sensor
		Sensor input	<ul style="list-style-type: none"> Differs from other DI signals, and is connected to the controller. This is only used for monitoring on the ladder side. 	3.1.2 PLC Switch/Sensor
		AI (Analog Input)	<ul style="list-style-type: none"> The connector pin allocation is determined. Allocated to the file register (R). 	PLC Interface Manual PLC Input Signals (Data Type: R***)
Output	DO	Machine	<ul style="list-style-type: none"> Allocated to device Y. The high-speed processing Output is set with the parameters. (Output at end of the high-speed processing scan.) 	3.2.1 Output Signals to Machine
		PLC Switch Output(*1)	<ul style="list-style-type: none"> Output used to show that setting and display unit PLC switch input is valid. Allocated to device Y. 	3.2.2 PLC Switch
		AO (Analog Output)	<ul style="list-style-type: none"> The connector pin allocation is determined. Data to be D/A converted and output can be output by reading it into the file register (R). 	PLC Interface Manual PLC Out Signals (Data Type: R***)

(*1) The PLC switches are not signals for directly inputting/outputting with the machine, and are hypothetical switches used by the user on the setting and display unit. When classified by property, they are as shown above.

3.1 Machine Input Signals

3.1.1 Input Signals from Machine

Device	Abbrev.	Signal name	Connector	Device	Abbrev.	Signal name	Connector
X0			B20	X8			B12
X1			B19	X9			B11
X2			B18	XA			B10
X3			B17	XB			B09
X4			B16	XC			B08
X5			B15	XD			B07
X6			B14	XE			B06
X7			B13	XF			B05

Device	Abbrev.	Signal name	Connector	Device	Abbrev.	Signal name	Connector
X10			A20	X18		Reference position return near point detection 1(*1)	A12
X11			A19	X19		Reference position return near point detection 2(*1)	A11
X12			A18	X1A		Reference position return near-point detection 3(*1)	A10
X13			A17	X1B		Reference position return near point detection 4(*1)	A09
X14			A16	X1C			A08
X15			A15	X1D			A07
X16			A14	X1E			A06
X17			A13	X1F			A05

Device	Abbrev.	Signal name	Connector	Device	Abbrev.	Signal name	Connector
X20		Stroke end -1(*1)	B20	X28		Stroke end +1(*1)	B12
X21		Stroke end -2(*1)	B19	X29		Stroke end +2(*1)	B11
X22		Stroke end -3(*1)	B18	X2A		Stroke end +3(*1)	B10
X23		Stroke end -4(*1)	B17	X2B		Stroke end +4(*1)	B09
X24			B16	X2C			B08
X25			B15	X2D			B07
X26			B14	X2E			B06
X27			B13	X2F			B05

Device	Abbrev.	Signal name	Connector	Device	Abbrev.	Signal name	Connector
X30			A20	X38			A12
X31			A19	X39			A11
X32			A18	X3A			A10
X33			A17	X3B			A09
X34			A16	X3C			A08
X35			A15	X3D			A07
X36			A14	X3E			A06
X37			A13	X3F			A05

(*1) For the allocations of the reference position return near-point detection and stroke end signals, refer to the section "2.3 Fixed Signals".

3 Input/Output Signals with Machine

3.1 Machine Input Signals

Device	Abbrev.	Signal name	Connector	Device	Abbrev.	Signal name	Connector
X40			B20	X48			B12
X41			B19	X49			B11
X42			B18	X4A			B10
X43			B17	X4B			B09
X44			B16	X4C			B08
X45			B15	X4D			B07
X46			B14	X4E			B06
X47			B13	X4F			B05

Device	Abbrev.	Signal name	Connector	Device	Abbrev.	Signal name	Connector
X50			A20	X58			A12
X51			A19	X59			A11
X52			A18	X5A			A10
X53			A17	X5B			A09
X54			A16	X5C		Reference position return near point detection 5(*1)	A08
X55			A15	X5D		Reference position return near point detection 6(*1)	A07
X56			A14	X5E		Reference position return near point detection 7(*1)	A06
X57			A13	X5F		Reference position return near point detection 8(*1)	A05

Device	Abbrev.	Signal name	Connector	Device	Abbrev.	Signal name	Connector
X60			B20	X68			B12
X61			B19	X69			B11
X62			B18	X6A			B10
X63			B17	X6B			B09
X64		Stroke end -5(*1)	B16	X6C		Stroke end +5(*1)	B08
X65		Stroke end -6(*1)	B15	X6D		Stroke end +6(*1)	B07
X66		Stroke end -7(*1)	B14	X6E		Stroke end +7(*1)	B06
X67		Stroke end -8(*1)	B13	X6F		Stroke end +8(*1)	B05

Device	Abbrev.	Signal name	Connector	Device	Abbrev.	Signal name	Connector
X70			A20	X78			A12
X71			A19	X79			A11
X72			A18	X7A			A10
X73			A17	X7B			A09
X74			A16	X7C			A08
X75			A15	X7D			A07
X76			A14	X7E			A06
X77			A13	X7F			A05

(*1) For the allocations of the reference position return near-point detection and stroke end signals, refer to the section "Fixed Signals".

3 Input/Output Signals with Machine

3.1 Machine Input Signals

Device	Abbrev.	Signal name	Connector	Device	Abbrev.	Signal name	Connector
X80			B20	X88			B12
X81			B19	X89			B11
X82			B18	X8A			B10
X83			B17	X8B			B09
X84			B16	X8C			B08
X85			B15	X8D			B07
X86			B14	X8E			B06
X87			B13	X8F			B05

Device	Abbrev.	Signal name	Connector	Device	Abbrev.	Signal name	Connector
X90			A20	X98			A12
X91			A19	X99			A11
X92			A18	X9A			A10
X93			A17	X9B			A09
X94			A16	X9C			A08
X95			A15	X9D			A07
X96			A14	X9E			A06
X97			A13	X9F			A05

Device	Abbrev.	Signal name	Connector	Device	Abbrev.	Signal name	Connector
XA0			B20	XA8			B12
XA1			B19	XA9			B11
XA2			B18	XAA			B10
XA3			B17	XAB			B09
XA4			B16	XAC			B08
XA5			B15	XAD			B07
XA6			B14	XAE			B06
XA7			B13	XAF			B05

Device	Abbrev.	Signal name	Connector	Device	Abbrev.	Signal name	Connector
XB0			A20	XB8			A12
XB1			A19	XB9			A11
XB2			A18	XBA			A10
XB3			A17	XBB			A09
XB4			A16	XBC			A08
XB5			A15	XBD			A07
XB6			A14	XBE			A06
XB7			A13	XBF			A05

3 Input/Output Signals with Machine

3.1 Machine Input Signals

Device	Abbrev.	Signal name	Connector	Device	Abbrev.	Signal name	Connector
XC0			B20	XC8			B12
XC1			B19	XC9			B11
XC2			B18	XCA			B10
XC3			B17	XCB			B09
XC4			B16	XCC			B08
XC5			B15	XCD			B07
XC6			B14	XCE			B06
XC7			B13	XCF			B05

Device	Abbrev.	Signal name	Connector	Device	Abbrev.	Signal name	Connector
XD0			A20	XD8			A12
XD1			A19	XD9			A11
XD2			A18	XDA			A10
XD3			A17	XDB			A09
XD4			A16	XDC			A08
XD5			A15	XDD			A07
XD6			A14	XDE			A06
XD7			A13	XDF			A05

Device	Abbrev.	Signal name	Connector	Device	Abbrev.	Signal name	Connector
XE0			B20	XE8			B12
XE1			B19	XE9			B11
XE2			B18	XEA			B10
XE3			B17	XEB			B09
XE4			B16	XEC			B08
XE5			B15	XED			B07
XE6			B14	XEE			B06
XE7			B13	XEF			B05

Device	Abbrev.	Signal name	Connector	Device	Abbrev.	Signal name	Connector
XF0			A20	XF8			A12
XF1			A19	XF9			A11
XF2			A18	XFA			A10
XF3			A17	XFB			A09
XF4			A16	XFC			A08
XF5			A15	XFD			A07
XF6			A14	XFE			A06
XF7			A13	XFF			A05

3 Input/Output Signals with Machine

3.1 Machine Input Signals

3.1.2 PLC Switch/Sensor

[PLC Switch Input]

Common for part systems	Abbrev.	Signal name	Common for part systems	Abbrev.	Signal name
X680		PLC switch #1	X688		PLC switch #9
X681		PLC switch #2	X689		PLC switch #10
X682		PLC switch #3	X68A		PLC switch #11
X683		PLC switch #4	X68B		PLC switch #12
X684		PLC switch #5	X68C		PLC switch #13
X685		PLC switch #6	X68D		PLC switch #14
X686		PLC switch #7	X68E		PLC switch #15
X687		PLC switch #8	X68F		PLC switch #16

Common for part systems	Abbrev.	Signal name	Common for part systems	Abbrev.	Signal name
X690		PLC switch #17	X698		PLC switch #25
X691		PLC switch #18	X699		PLC switch #26
X692		PLC switch #19	X69A		PLC switch #27
X693		PLC switch #20	X69B		PLC switch #28
X694		PLC switch #21	X69C		PLC switch #29
X695		PLC switch #22	X69D		PLC switch #30
X696		PLC switch #23	X69E		PLC switch #31
X697		PLC switch #24	X69F		PLC switch #32

Common for part systems	Abbrev.	Signal name	Common for part systems	Abbrev.	Signal name
X6A0		PLC switch #33	X6A8		PLC switch #41
X6A1		PLC switch #34	X6A9		PLC switch #42
X6A2		PLC switch #35	X6AA		PLC switch #43
X6A3		PLC switch #36	X6AB		PLC switch #44
X6A4		PLC switch #37	X6AC		PLC switch #45
X6A5		PLC switch #38	X6AD		PLC switch #46
X6A6		PLC switch #39	X6AE		PLC switch #47
X6A7		PLC switch #40	X6AF		PLC switch #48

Common for part systems	Abbrev.	Signal name	Common for part systems	Abbrev.	Signal name
X6B0		PLC switch #49	X6B8		PLC switch #57
X6B1		PLC switch #50	X6B9		PLC switch #58
X6B2		PLC switch #51	X6BA		PLC switch #59
X6B3		PLC switch #52	X6BB		PLC switch #60
X6B4		PLC switch #53	X6BC		PLC switch #61
X6B5		PLC switch #54	X6BD		PLC switch #62
X6B6		PLC switch #55	X6BE		PLC switch #63
X6B7		PLC switch #56	X6BF		PLC switch #64

Note

(1) Device Nos. X6A0 to X6BF are assigned when 64 points are provided for the switches.

3 Input/Output Signals with Machine

3.1 Machine Input Signals

Common for part systems	Abbrev.	Signal name	Common for part systems	Abbrev.	Signal name
X1C40		PLC switch #65	X1C48		PLC switch #73
X1C41		PLC switch #66	X1C49		PLC switch #74
X1C42		PLC switch #67	X1C4A		PLC switch #75
X1C43		PLC switch #68	X1C4B		PLC switch #76
X1C44		PLC switch #69	X1C4C		PLC switch #77
X1C45		PLC switch #70	X1C4D		PLC switch #78
X1C46		PLC switch #71	X1C4E		PLC switch #79
X1C47		PLC switch #72	X1C4F		PLC switch #80

Common for part systems	Abbrev.	Signal name	Common for part systems	Abbrev.	Signal name
X1C50		PLC switch #81	X1C58		PLC switch #89
X1C51		PLC switch #82	X1C59		PLC switch #90
X1C52		PLC switch #83	X1C5A		PLC switch #91
X1C53		PLC switch #84	X1C5B		PLC switch #92
X1C54		PLC switch #85	X1C5C		PLC switch #93
X1C55		PLC switch #86	X1C5D		PLC switch #94
X1C56		PLC switch #87	X1C5E		PLC switch #95
X1C57		PLC switch #88	X1C5F		PLC switch #96

Note

(1) Device Nos. X1C40 to X1C5F are assigned when 64 points are provided for the switches.

[Sensor input]

Common for part systems	Abbrev.	Signal name	Common for part systems	Abbrev.	Signal name
X6F0			X6F8		Skip input 1
X6F1			X6F9		Skip input 2
X6F2			X6FA		Skip input 3
X6F3			X6FB		Skip input 4
X6F4			X6FC		Skip input 5
X6F5			X6FD		Skip input 6
X6F6			X6FE		Skip input 7
X6F7			X6FF		Skip input 8

3.2 Machine Output Signals

3.2.1 Output Signals to Machine

Device	Abbrev.	Signal name	Connector	Device	Abbrev.	Signal name	Connector
Y0			B20	Y8			B12
Y1			B19	Y9			B11
Y2			B18	YA			B10
Y3			B17	YB			B09
Y4			B16	YC			B08
Y5			B15	YD			B07
Y6			B14	YE			B06
Y7			B13	YF			B05

Device	Abbrev.	Signal name	Connector	Device	Abbrev.	Signal name	Connector
Y10			A20	Y18			A12
Y11			A19	Y19			A11
Y12			A18	Y1A			A10
Y13			A17	Y1B			A09
Y14			A16	Y1C			A08
Y15			A15	Y1D			A07
Y16			A14	Y1E			A06
Y17			A13	Y1F			A05

Device	Abbrev.	Signal name	Connector	Device	Abbrev.	Signal name	Connector
Y20			B20	Y28			B12
Y21			B19	Y29			B11
Y22			B18	Y2A			B10
Y23			B17	Y2B			B09
Y24			B16	Y2C			B08
Y25			B15	Y2D			B07
Y26			B14	Y2E			B06
Y27			B13	Y2F			B05

Device	Abbrev.	Signal name	Connector	Device	Abbrev.	Signal name	Connector
Y30			A20	Y38			A12
Y31			A19	Y39			A11
Y32			A18	Y3A			A10
Y33			A17	Y3B			A09
Y34			A16	Y3C			A08
Y35			A15	Y3D			A07
Y36			A14	Y3E			A06
Y37			A13	Y3F			A05

3 Input/Output Signals with Machine

3.2 Machine Output Signals

Device	Abbrev.	Signal name	Connector	Device	Abbrev.	Signal name	Connector
Y40			B20	Y48			B12
Y41			B19	Y49			B11
Y42			B18	Y4A			B10
Y43			B17	Y4B			B09
Y44			B16	Y4C			B08
Y45			B15	Y4D			B07
Y46			B14	Y4E			B06
Y47			B13	Y4F			B05

Device	Abbrev.	Signal name	Connector	Device	Abbrev.	Signal name	Connector
Y50			A20	Y58			A12
Y51			A19	Y59			A11
Y52			A18	Y5A			A10
Y53			A17	Y5B			A09
Y54			A16	Y5C			A08
Y55			A15	Y5D			A07
Y56			A14	Y5E			A06
Y57			A13	Y5F			A05

Device	Abbrev.	Signal name	Connector	Device	Abbrev.	Signal name	Connector
Y60			B20	Y68			B12
Y61			B19	Y69			B11
Y62			B18	Y6A			B10
Y63			B17	Y6B			B09
Y64			B16	Y6C			B08
Y65			B15	Y6D			B07
Y66			B14	Y6E			B06
Y67			B13	Y6F			B05

Device	Abbrev.	Signal name	Connector	Device	Abbrev.	Signal name	Connector
Y70			A20	Y78			A12
Y71			A19	Y79			A11
Y72			A18	Y7A			A10
Y73			A17	Y7B			A09
Y74			A16	Y7C			A08
Y75			A15	Y7D			A07
Y76			A14	Y7E			A06
Y77			A13	Y7F			A05

3 Input/Output Signals with Machine

3.2 Machine Output Signals

Device	Abbrev.	Signal name	Connector	Device	Abbrev.	Signal name	Connector
Y80			B20	Y88			B12
Y81			B19	Y89			B11
Y82			B18	Y8A			B10
Y83			B17	Y8B			B09
Y84			B16	Y8C			B08
Y85			B15	Y8D			B07
Y86			B14	Y8E			B06
Y87			B13	Y8F			B05

Device	Abbrev.	Signal name	Connector	Device	Abbrev.	Signal name	Connector
Y90			A20	Y98			A12
Y91			A19	Y99			A11
Y92			A18	Y9A			A10
Y93			A17	Y9B			A09
Y94			A16	Y9C			A08
Y95			A15	Y9D			A07
Y96			A14	Y9E			A06
Y97			A13	Y9F			A05

Device	Abbrev.	Signal name	Connector	Device	Abbrev.	Signal name	Connector
YA0			B20	YA8			B12
YA1			B19	YA9			B11
YA2			B18	YAA			B10
YA3			B17	YAB			B09
YA4			B16	YAC			B08
YA5			B15	YAD			B07
YA6			B14	YAE			B06
YA7			B13	YAF			B05

Device	Abbrev.	Signal name	Connector	Device	Abbrev.	Signal name	Connector
YB0			A20	YB8			A12
YB1			A19	YB9			A11
YB2			A18	YBA			A10
YB3			A17	YBB			A09
YB4			A16	YBC			A08
YB5			A15	YBD			A07
YB6			A14	YBE			A06
YB7			A13	YBF			A05

3 Input/Output Signals with Machine

3.2 Machine Output Signals

Device	Abbrev.	Signal name	Connector	Device	Abbrev.	Signal name	Connector
YC0			B20	YC8			B12
YC1			B19	YC9			B11
YC2			B18	YCA			B10
YC3			B17	YCB			B09
YC4			B16	YCC			B08
YC5			B15	YCD			B07
YC6			B14	YCE			B06
YC7			B13	YCF			B05

Device	Abbrev.	Signal name	Connector	Device	Abbrev.	Signal name	Connector
YD0			A20	YD8			A12
YD1			A19	YD9			A11
YD2			A18	YDA			A10
YD3			A17	YDB			A09
YD4			A16	YDC			A08
YD5			A15	YDD			A07
YD6			A14	YDE			A06
YD7			A13	YDF			A05

Device	Abbrev.	Signal name	Connector	Device	Abbrev.	Signal name	Connector
YE0			B20	YE8			B12
YE1			B19	YE9			B11
YE2			B18	YEA			B10
YE3			B17	YEB			B09
YE4			B16	YEC			B08
YE5			B15	YED			B07
YE6			B14	YEE			B06
YE7			B13	YEF			B05

Device	Abbrev.	Signal name	Connector	Device	Abbrev.	Signal name	Connector
YF0			A20	YF8			A12
YF1			A19	YF9			A11
YF2			A18	YFA			A10
YF3			A17	YFB			A09
YF4			A16	YFC			A08
YF5			A15	YFD			A07
YF6			A14	YFE			A06
YF7			A13	YFF			A05

3.2.2 PLC Switch

[PLC Switch Output]

Common for part systems	Abbrev.	Signal name	Common for part systems	Abbrev.	Signal name
Y680		PLC switch reversed display #1	Y688		PLC switch reversed display #9
Y681		PLC switch reversed display #2	Y689		PLC switch reversed display #10
Y682		PLC switch reversed display #3	Y68A		PLC switch reversed display #11
Y683		PLC switch reversed display #4	Y68B		PLC switch reversed display #12
Y684		PLC switch reversed display #5	Y68C		PLC switch reversed display #13
Y685		PLC switch reversed display #6	Y68D		PLC switch reversed display #14
Y686		PLC switch reversed display #7	Y68E		PLC switch reversed display #15
Y687		PLC switch reversed display #8	Y68F		PLC switch reversed display #16

Common for part systems	Abbrev.	Signal name	Common for part systems	Abbrev.	Signal name
Y690		PLC switch reversed display #17	Y698		PLC switch reversed display #25
Y691		PLC switch reversed display #18	Y699		PLC switch reversed display #26
Y692		PLC switch reversed display #19	Y69A		PLC switch reversed display #27
Y693		PLC switch reversed display #20	Y69B		PLC switch reversed display #28
Y694		PLC switch reversed display #21	Y69C		PLC switch reversed display #29
Y695		PLC switch reversed display #22	Y69D		PLC switch reversed display #30
Y696		PLC switch reversed display #23	Y69E		PLC switch reversed display #31
Y697		PLC switch reversed display #24	Y69F		PLC switch reversed display #32

Common for part systems	Abbrev.	Signal name	Common for part systems	Abbrev.	Signal name
Y6A0		PLC switch reversed display #33	Y6A8		PLC switch reversed display #41
Y6A1		PLC switch reversed display #34	Y6A9		PLC switch reversed display #42
Y6A2		PLC switch reversed display #35	Y6AA		PLC switch reversed display #43
Y6A3		PLC switch reversed display #36	Y6AB		PLC switch reversed display #44
Y6A4		PLC switch reversed display #37	Y6AC		PLC switch reversed display #45
Y6A5		PLC switch reversed display #38	Y6AD		PLC switch reversed display #46
Y6A6		PLC switch reversed display #39	Y6AE		PLC switch reversed display #47
Y6A7		PLC switch reversed display #40	Y6AF		PLC switch reversed display #48

Common for part systems	Abbrev.	Signal name	Common for part systems	Abbrev.	Signal name
Y6B0		PLC switch reversed display #49	Y6B8		PLC switch reversed display #57
Y6B1		PLC switch reversed display #50	Y6B9		PLC switch reversed display #58
Y6B2		PLC switch reversed display #51	Y6BA		PLC switch reversed display #59
Y6B3		PLC switch reversed display #52	Y6BB		PLC switch reversed display #60
Y6B4		PLC switch reversed display #53	Y6BC		PLC switch reversed display #61
Y6B5		PLC switch reversed display #54	Y6BD		PLC switch reversed display #62
Y6B6		PLC switch reversed display #55	Y6BE		PLC switch reversed display #63
Y6B7		PLC switch reversed display #56	Y6BF		PLC switch reversed display #64

Note

(1) Device Nos. Y6A0 to Y6BF are assigned when 64 points are provided for the switches.

3 Input/Output Signals with Machine

3.2 Machine Output Signals

Common for part systems	Abbrev.	Signal name	Common for part systems	Abbrev.	Signal name
Y1C40		PLC switch reversed display #65	Y1C48		PLC switch reversed display #73
Y1C41		PLC switch reversed display #66	Y1C49		PLC switch reversed display #74
Y1C42		PLC switch reversed display #67	Y1C4A		PLC switch reversed display #75
Y1C43		PLC switch reversed display #68	Y1C4B		PLC switch reversed display #76
Y1C44		PLC switch reversed display #69	Y1C4C		PLC switch reversed display #77
Y1C45		PLC switch reversed display #70	Y1C4D		PLC switch reversed display #78
Y1C46		PLC switch reversed display #71	Y1C4E		PLC switch reversed display #79
Y1C47		PLC switch reversed display #72	Y1C4F		PLC switch reversed display #80

Common for part systems	Abbrev.	Signal name	Common for part systems	Abbrev.	Signal name
Y1C50		PLC switch reversed display #81	Y1C58		PLC switch reversed display #89
Y1C51		PLC switch reversed display #82	Y1C59		PLC switch reversed display #90
Y1C52		PLC switch reversed display #83	Y1C5A		PLC switch reversed display #91
Y1C53		PLC switch reversed display #84	Y1C5B		PLC switch reversed display #92
Y1C54		PLC switch reversed display #85	Y1C5C		PLC switch reversed display #93
Y1C55		PLC switch reversed display #86	Y1C5D		PLC switch reversed display #94
Y1C56		PLC switch reversed display #87	Y1C5E		PLC switch reversed display #95
Y1C57		PLC switch reversed display #88	Y1C5F		PLC switch reversed display #96

Note

(1) Device Nos. Y1C40 to Y1C5F are assigned when 64 points are provided for the switches.

3 Input/Output Signals with Machine

3.2 Machine Output Signals

Common for part systems	Abbrev.	Signal name	Common for part systems	Abbrev.	Signal name
Y6C0		PLC switch for reverse #1	Y6C8		PLC switch for reverse #9
Y6C1		PLC switch for reverse #2	Y6C9		PLC switch for reverse #10
Y6C2		PLC switch for reverse #3	Y6CC		PLC switch for reverse #11
Y6C3		PLC switch for reverse #4	Y6CB		PLC switch for reverse #12
Y6C4		PLC switch for reverse #5	Y6CC		PLC switch for reverse #13
Y6C5		PLC switch for reverse #6	Y6CD		PLC switch for reverse #14
Y6C6		PLC switch for reverse #7	Y6CE		PLC switch for reverse #15
Y6C7		PLC switch for reverse #8	Y6CF		PLC switch for reverse #16

Common for part systems	Abbrev.	Signal name	Common for part systems	Abbrev.	Signal name
Y6D0		PLC switch for reverse #17	Y6D8		PLC switch for reverse #25
Y6D1		PLC switch for reverse #18	Y6D9		PLC switch for reverse #26
Y6D2		PLC switch for reverse #19	Y6DA		PLC switch for reverse #27
Y6D3		PLC switch for reverse #20	Y6DB		PLC switch for reverse #28
Y6D4		PLC switch for reverse #21	Y6DC		PLC switch for reverse #29
Y6D5		PLC switch for reverse #22	Y6DD		PLC switch for reverse #30
Y6D6		PLC switch for reverse #23	Y6DE		PLC switch for reverse #31
Y6D7		PLC switch for reverse #24	Y6DF		PLC switch for reverse #32

Common for part systems	Abbrev.	Signal name	Common for part systems	Abbrev.	Signal name
Y6E0		PLC switch for reverse #33	Y6E8		PLC switch for reverse #41
Y6E1		PLC switch for reverse #34	Y6E9		PLC switch for reverse #42
Y6E2		PLC switch for reverse #35	Y6EA		PLC switch for reverse #43
Y6E3		PLC switch for reverse #36	Y6EB		PLC switch for reverse #44
Y6E4		PLC switch for reverse #37	Y6EC		PLC switch for reverse #45
Y6E5		PLC switch for reverse #38	Y6ED		PLC switch for reverse #46
Y6E6		PLC switch for reverse #39	Y6EE		PLC switch for reverse #47
Y6E7		PLC switch for reverse #40	Y6EF		PLC switch for reverse #48

Common for part systems	Abbrev.	Signal name	Common for part systems	Abbrev.	Signal name
Y6F0		PLC switch for reverse #49	Y6F8		PLC switch for reverse #57
Y6F1		PLC switch for reverse #50	Y6F9		PLC switch for reverse #58
Y6F2		PLC switch for reverse #51	Y6FA		PLC switch for reverse #59
Y6F3		PLC switch for reverse #52	Y6FB		PLC switch for reverse #60
Y6F4		PLC switch for reverse #53	Y6FC		PLC switch for reverse #61
Y6F5		PLC switch for reverse #54	Y6FD		PLC switch for reverse #62
Y6F6		PLC switch for reverse #55	Y6FE		PLC switch for reverse #63
Y6F7		PLC switch for reverse #56	Y6FF		PLC switch for reverse #64

Note

(1) Device Nos. Y6E0 to Y6FF are assigned when 64 points are provided for the switches.

3 Input/Output Signals with Machine

3.2 Machine Output Signals

Common for part systems	Abbrev.	Signal name	Common for part systems	Abbrev.	Signal name
Y1C60		PLC switch for reverse #65	Y1C68		PLC switch for reverse #73
Y1C61		PLC switch for reverse #66	Y1C69		PLC switch for reverse #74
Y1C62		PLC switch for reverse #67	Y1C6A		PLC switch for reverse #75
Y1C63		PLC switch for reverse #68	Y1C6B		PLC switch for reverse #76
Y1C64		PLC switch for reverse #69	Y1C6C		PLC switch for reverse #77
Y1C65		PLC switch for reverse #70	Y1C6D		PLC switch for reverse #78
Y1C66		PLC switch for reverse #71	Y1C6E		PLC switch for reverse #79
Y1C67		PLC switch for reverse #72	Y1C6F		PLC switch for reverse #80

Common for part systems	Abbrev.	Signal name	Common for part systems	Abbrev.	Signal name
Y1C70		PLC switch for reverse #81	Y1C78		PLC switch for reverse #89
Y1C71		PLC switch for reverse #82	Y1C79		PLC switch for reverse #90
Y1C72		PLC switch for reverse #83	Y1C7A		PLC switch for reverse #91
Y1C73		PLC switch for reverse #84	Y1C7B		PLC switch for reverse #92
Y1C74		PLC switch for reverse #85	Y1C7C		PLC switch for reverse #93
Y1C75		PLC switch for reverse #86	Y1C7D		PLC switch for reverse #94
Y1C76		PLC switch for reverse #87	Y1C7E		PLC switch for reverse #95
Y1C77		PLC switch for reverse #88	Y1C7F		PLC switch for reverse #96

Note

(1) Device Nos. Y1C60 to Y1C7F are assigned when 96 points are provided for the switches.

System Configuration of Development Environment

4.1 System Configuration for PLC Development

The general configuration of the development environment is shown below.

Most of the development work is carried out with "GX Developer" or "GX Works2", which runs on a personal computer. GX Developer/GX Works2 and the CNC control unit are connected with Ethernet at this time.

On the CNC unit PLC on-board edit screen, it is possible to use the data saved with GX Developer/GX Works2 or develop PLC programs, as well. Note that some functions may be limited. (Print output, Japanese input, etc.)

Note

(1) Do not use GX Developer/GX Works2 simultaneously when several PCs are connected with NC.

[General configuration of development environment]

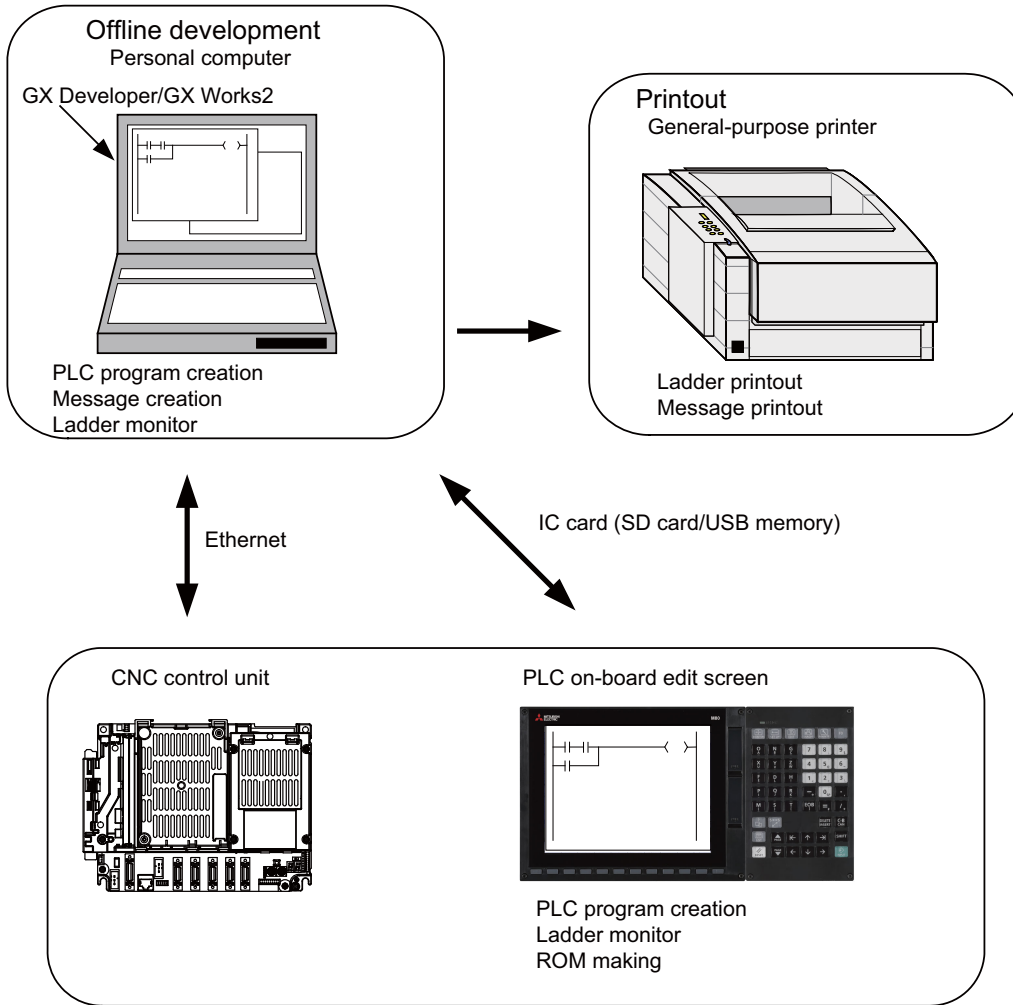

Note

Note the following points when using the SD card or USB memory.

- (1) Do not remove the SD card/USB memory during reading data.
- (2) If a card must be inserted and removed while the power is ON, make sure to take sufficient time (approve. ten seconds or more) between the insertion and removal.
- (3) Do not pull out the card or turn OFF the power during access to the SD card. Failure to observe this could cause the memory contents to be erased.
- (4) Do not connect the devices other than the USB memory. (including extension cable and USB hub)
- (5) It is recommended to use genuine SD cards. Mitsubishi Electric does not guarantee the machine operation when a commercially available SD card/USB memory is used. In that case, performance check must be made carefully by machine tool builder.

4.2 User PLC (Ladder) Development Procedure

User PLC programs can be created and input by means of either GX Developer/GX Works2 installed in the external PC or PLC on-board edit screen.

Procedures for creating/inputting PLC programs with either method are shown below.

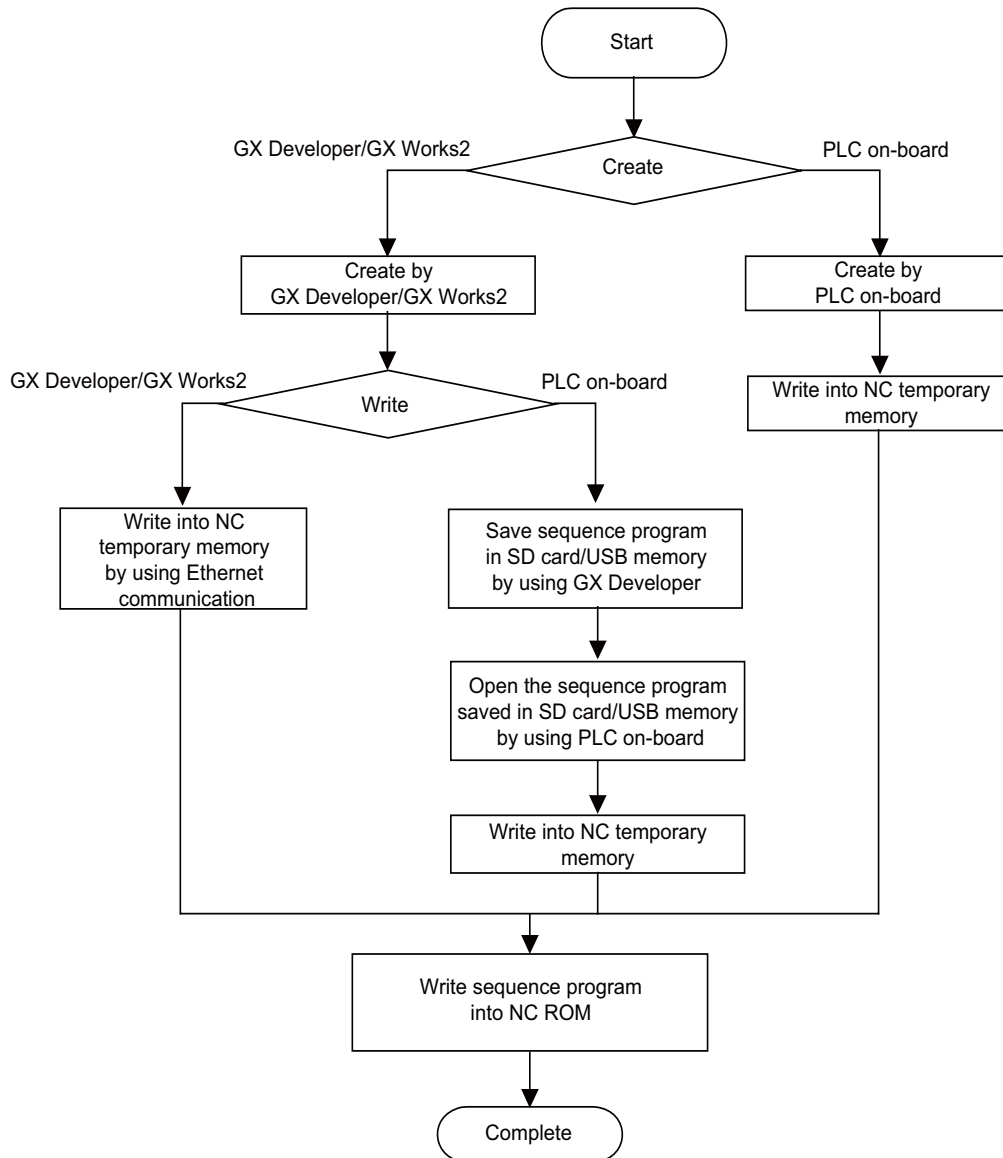

Next, procedures for creating sequence programs are shown below.

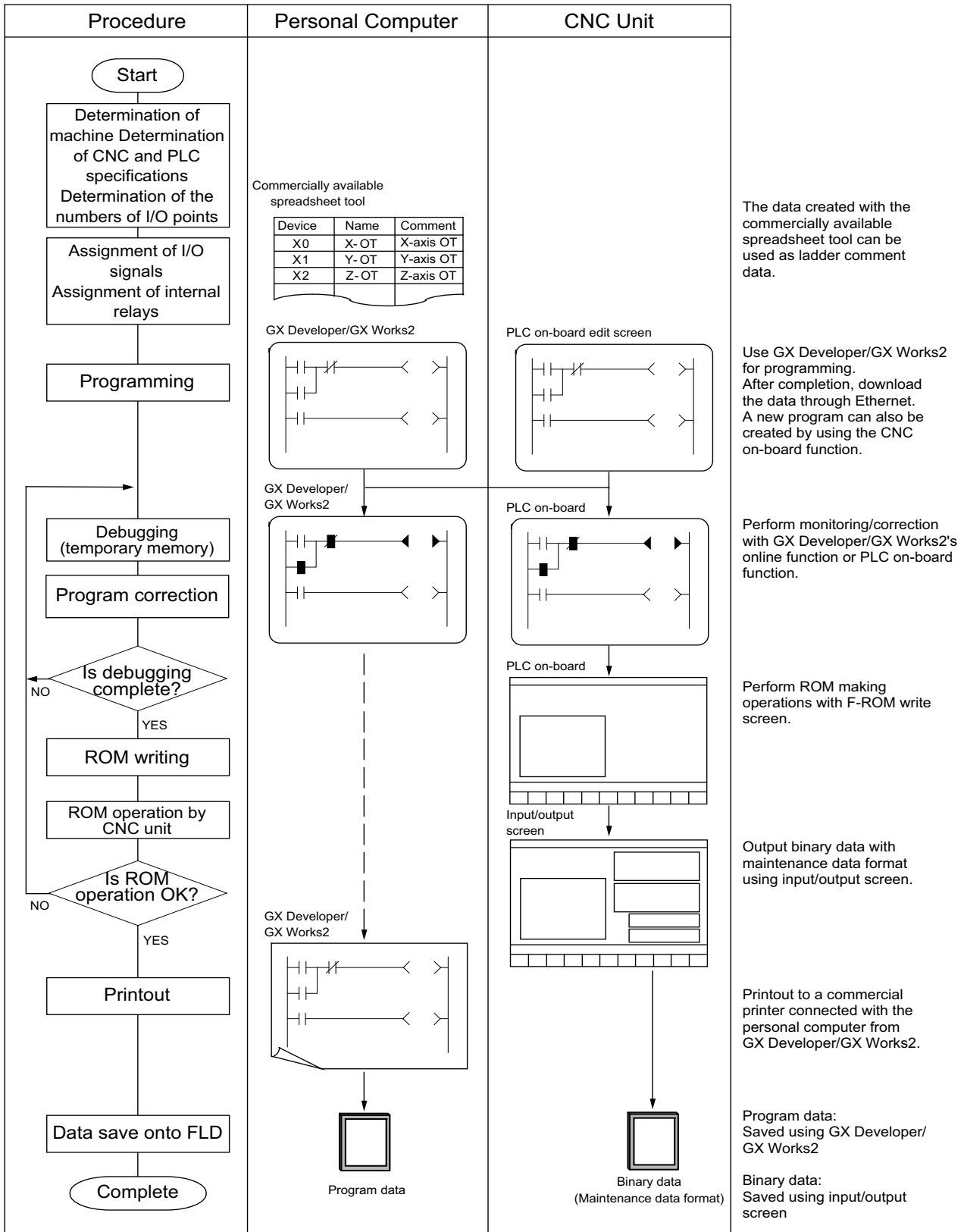

It is recommended to use genuine SD cards. Mitsubishi Electric does not guarantee the machine operation when a commercially available SD card is used. In that case, performance check must be made carefully by machine tool builder. For descriptions regarding the user PLC development environment using GX Developer, refer to the relevant manuals and specifications manuals on "Manual List".

Peripheral Development Environment (GX Works2)

5.1 Outline

This CNC supports user PLC development environment using Mitsubishi Electric FA engineering software GX Works2, which is the PLC development tool for PLC MELSEC Series.

This manual describes user PLC development environment using GX Works2, focusing on usage specific to Mitsubishi Electric CNC.

GX Developer is installed when GX Works2 is installed.

The difference between machine sequence and user safety sequence is as follows.

Machine sequence: Control ladder to control machine tools

User safety sequence: Control ladder for safety-related I/O observation created by the Smart Safety observation function

For the smart safety observation function, refer to "M800/M80 Series Smart safety observation Specification manual".

5.1.1 Software Configuration

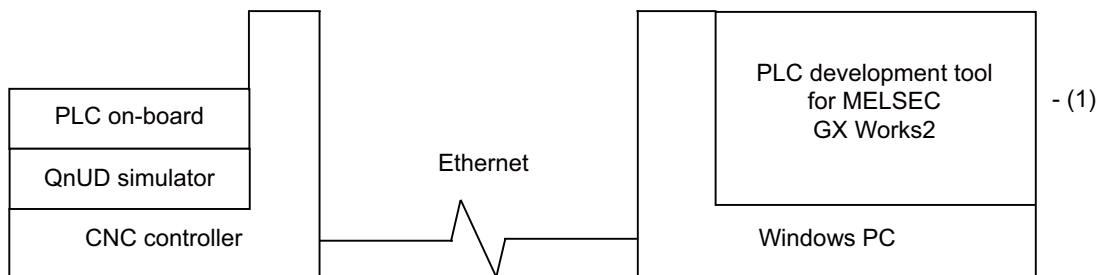

(1) GX Works2 (PLC development software package)

GX Works2 is a programming software package (model name:SW1DND-GXW2) for Mitsubishi Electric programmable controller MELSEC series. It enables sequence programs for Mitsubishi Electric CNC series to be developed using similar operations to those for MELSEC series. Some of the functions are exclusively for MELSEC series and cannot be used in developing sequence programs for CNC.

GX Works2 Version 1.570U or newer version is recommended for developing sequence programs for Mitsubishi Electric CNC series. For details of the functions, refer to each of "GX Works2 Operating Manuals".

5.1.2 Operating Environment

The tools that make up the development environment can be used with the personal computer that satisfies the following operating environment of GX Works2.

The following are the specifications of the "GX Works2 Version 1.568S" operating environment. For details on the specifications of different versions, consult "GX Works2 Installation Instructions".

Item		Description
Personal computer		Personal computer supporting Windows operating systems
Performance	CPU	Intel Core 2 Duo processor 2 GHz or higher
	Required memory	64 bit OS: 2 GB or larger is recommended 32 bit OS: 1GB or larger is recommended
Available hard disk space		2.5 GB or larger is required for installation (17 GB or larger is required for installation of GX Works3) 512 MB or larger (virtual memory) is required for operation
Monitor		Resolution of 1024 × 768 pixels or higher
Communication interface		Ethernet port
OS (English version)		<ul style="list-style-type: none"> ♦ Windows 10 (Home, Pro, Enterprise, Education, IoT Enterprise 2016 LTSB (*1)) ♦ Windows 8.1, Windows 8.1 (Pro, Enterprise) ♦ Windows 8, Windows 8 (Pro, Enterprise) ♦ Windows 7 (Starter, Home Premium, Professional, Ultimate, Enterprise) ♦ Windows Vista (Home Basic, Home Premium, Ultimate, Business, Enterprise) (*2) ♦ Windows XP (Professional SP3, Home SP3) (*2)

(*1) 64-bit version is not supported.

(*2) 32-bit version is not supported.

Note

- (1) For details of the system requirements for GX Works3, refer to GX Works3 Installation Instructions.
GX Works3 is only used to display project verification results in ladder diagrams in developing sequence programs for CNC.

5.2 Types of GX Works2 Projects and Programs Used for Mitsubishi Electric CNC

This chapter describes the types of GX Works2 projects and programs that can be used in developing ladders for CNC controllers.

5.2.1 Support Status of Project Types, Program Types and POU's

The following lists show the project types that can be used in developing ladders for CNC controllers, and the program types and POU's (Program Organization Units) that can be handled in each project type.

The program types marked by ☉ can be used in developing ladders for this CNC.

The program types marked by × cannot be used in developing ladders for this CNC.

The difference between machine sequence and user safety sequence is as follows.

Machine sequence: Control ladder to control machine tools

User safety sequence: Control ladder for safety-related I/O observation created by the Smart Safety observation function

[List of project types]

☉ : Supported; × : Not supported

Program type	Machine sequence	User safety sequence	Support in GX Developer	Remarks
Simple project (without labels)	☉	☉	☉	
Simple project (with labels)	☉	☉	×	The label function can only be monitored in PLC on-board
Structured project	☉	☉	×	Structured projects can only be monitored in PLC on-board

Note

- By selecting [Project] - [Change Project Type], simple projects (without labels) can be changed to simple projects (with labels), and simple projects (with labels) to structured projects after they are created. Note that these changes cannot be reverted.

[List of program types for simple projects (without labels)]

☉ : Supported; × : Not supported

Program type	Machine sequence	User safety sequence	Support in GX Developer	Remarks
Ladder (without labels)	☉	☉	☉	
List	×	×	☉	Editing list for each ladder block is possible
ST	×	×	×	
SFC	×	×	×	

[List of POU's for simple projects (without labels)]

☉ : Supported; × : Not supported

Program type	Machine sequence	User safety sequence	Support in GX Developer	Remarks
FB	×	×	×	
Structure	×	×	×	
Function	×	×	×	

[List of program types for simple projects (with labels)]

◎ : Supported; × : Not supported

Program type	Machine sequence	User safety sequence	Support in GX Developer	Remarks
Ladder (with labels)	◎	◎	×	The label function can only be monitored in PLC on-board
List	×	×	×	Editing list for each ladder block is possible
ST	◎	◎	×	In-line structured text is unavailable
SFC	×	×	×	

[List of POUs for simple projects (with labels)]

◎ : Supported; × : Not supported

Element	Machine sequence	User safety sequence	Support in GX Developer	Remarks
FB	◎	◎	×	Can only be monitored in PLC on-board Only one-level nesting is allowed for ladder Up to four-level nesting is allowed for structured text
Structure	◎	◎	×	
Function	×	×	×	

[List of program types for structured project]

◎ : Supported; × : Not supported

Program type	Machine sequence	User safety sequence	Support in GX Developer	Remarks
Ladder (with labels)	◎	◎	×	The label function can only be monitored in PLC on-board
List	×	×	×	Editing list for each ladder block is possible
ST	◎	◎	×	Inline structured text is unavailable
SFC	×	×	×	
Structured ladder/FBD	×	×	×	

[List of POUs for structured project]

◎ : Supported; × : Not supported

Element	Machine sequence	User safety sequence	Support in GX Developer	Remarks
FB	◎	◎	×	Can only be monitored in PLC on-board Only one-level nesting is allowed for ladder Nesting of structured text • Up to four-level nesting is allowed for macro type FB • Up to fifteen-level nesting is allowed for subroutine type FB
Structure	◎	◎	×	
Function	◎	◎	×	Available only when structured text is selected

5.3 GX Works2 Functions Available for Mitsubishi Electric CNC

This chapter lists the GX Works2 functions that this CNC supports. For details of each function, refer to "GX Works2 Operating Manual (Common)", "GX Works2 Operating Manual (Simple Project)" and "GX Works2 Operating Manual (Structured Project)".

The © mark indicates functions that can be used currently with this CNC.

The functions marked by × are exclusively for MELSEC series, and unavailable for this CNC.

The list of device memory functions is omitted because none of the functions is available for this CNC.

5.3.1 Function Support Status (Common Functions)

⊙ : Supported; △ : Supported with restrictions; × : Not supported

Function	Menu	Sub menu	Machine sequence	User safety sequence	Remarks	
Project	New		⊙	⊙		
	Open		⊙	⊙		
	Close		⊙	⊙		
	Save		⊙	⊙		
	Save As		⊙	⊙		
	Compress/Unpack		⊙	⊙		
	Delete		⊙	⊙		
	Verify		⊙	⊙	Verification results can be displayed in ladder diagram on GX Works3.	
	Project Revision		Revision Entry	⊙	⊙	
			Revision List	⊙	⊙	
	Change PLC Type			×	×	
	Change Project Type			⊙	⊙	
	Object		New	⊙	⊙	
			Rename	⊙	⊙	
			Delete	⊙	⊙	
			Copy	⊙	⊙	
			Paste	⊙	⊙	
			Set as Default Connection	⊙	⊙	
			Property	⊙	⊙	
	Intelligent Function Module			×	×	
	Open Other Data		Open Other Project	⊙	⊙	
			Read ASC Format File	×	×	
	Export to GX Developer Format File			⊙	⊙	
	Library		Create	⊙	⊙	
			Install	⊙	⊙	
			Export FB to Library (Project)	⊙	⊙	
			Deinstall	⊙	⊙	
			Reload	⊙	⊙	
			Rename	⊙	⊙	
			Open	⊙	⊙	
			Close	⊙	⊙	
			Change Password	⊙	⊙	
			Save As	⊙	⊙	
			Save	⊙	⊙	
			Help	⊙	⊙	
			Security		Change Password	⊙
	User Management	⊙			⊙	
	Data Security Setting	⊙			⊙	
	Soft Security Key Management	×			×	
	Print			⊙	⊙	
	Print Preview			⊙	⊙	
	Print Window			⊙	⊙	
	Print Window Preview			⊙	⊙	
	Printer Setup			⊙	⊙	
	Recently used files			⊙	⊙	
	Start GX Developer			⊙	⊙	
	Exit			⊙	⊙	

⊙ : Supported; △ : Supported with restrictions; ×: Not supported

Function	Menu	Sub menu	Machine sequence	User safety sequence	Remarks	
Edit	Undo		⊙	⊙		
	Redo		⊙	⊙		
	Cut		⊙	⊙		
	Copy		⊙	⊙		
	Paste		⊙	⊙		
Find/Replace	Cross Reference		⊙	⊙		
	Device List		⊙	⊙		
	Find Device		⊙	⊙		
	Find Instruction		⊙	⊙		
	Find Contact or Coil		⊙	⊙		
	Find String		⊙	⊙		
	Replace Device		⊙	⊙		
	Replace Instruction		⊙	⊙		
	Replace String		⊙	⊙		
	Change Open/Close Contact		⊙	⊙		
	Device Batch Replace		⊙	⊙		
	Register to Device Batch Replace		⊙	⊙		
Compile	Build		⊙	⊙	Displayed on programming without labels	
	Build		⊙	⊙	Displayed on programming with labels	
	Online Program Change		⊙	×	Displayed on programming without labels	
	Online Program Change		⊙	×	Displayed on programming with labels	
	Rebuild All		⊙	⊙	Displayed on programming without labels	
	Rebuild All		⊙	⊙	Displayed on programming with labels	
Display	Toolbar	Toolbar name	⊙	⊙		
		Display All	⊙	⊙		
	Status bar		⊙	⊙		
	Color and Font		⊙	⊙		
	Docking Window	Navigation		⊙	⊙	
		Element Selection		⊙	⊙	
		Output		⊙	⊙	
		Cross Reference		⊙	⊙	
		Device List		⊙	⊙	
		Device Reference		×	×	
		Watch		⊙	⊙	
		Intelligent Function Module Monitor		×	×	
		Intelligent Function Module Guidance		×	×	
		Find/Replace		⊙	⊙	
		Debug		⊙	⊙	
Reset the Window Position to its Default		⊙	⊙			

⊙ : Supported; △ : Supported with restrictions; × : Not supported

Function	Menu	Sub menu	Machine sequence	User safety sequence	Remarks	
Debug	Start/Stop Simulation		⊙	⊙		
	Instructions Unsupported by Simulation		⊙	⊙		
	Step Execution	Stop		⊙	⊙	
		Cancel		⊙	⊙	
		Break Execution		⊙	⊙	
		Step Execution		⊙	⊙	
		Enter in FB		×	×	
		Exit from FB		×	×	
		Block Execution		×	×	
		Scan Execution		×	×	
		Jump to the Canceled Position		×	×	
		Execution Option		⊙	⊙	
	Break Setting	Set/Cancel Break Point		⊙	⊙	
		Enable/Disable Break Point		⊙	⊙	
		Cancel All Break Points		⊙	⊙	
		Break Point Window		⊙	⊙	
		Cancel All Break Devices		⊙	⊙	
		Break Device Window		⊙	⊙	
	Skip Setting	Set/Cancel Skip Range		⊙	⊙	
		Enable/Disable Skip Range		⊙	⊙	
		Cancel All Skip Ranges		⊙	⊙	
		Skip Range Window		⊙	⊙	

⊙ : Supported; △ : Supported with restrictions; ×: Not supported

Function	Menu	Sub menu	Machine sequence	User safety sequence	Remarks	
Tool	IC Memory Card	Read IC Memory Card	⊙	⊙		
		Write IC Memory Card	⊙	⊙		
		Read Image Data	⊙	⊙		
		Write Image Data	⊙	⊙		
		Read IC Memory Card (Edit + Data Copy)	×	×		
		Write IC Memory Card (Edit + Data Copy)	×	×		
		Check Program		⊙	⊙	
		Check Parameter		⊙	⊙	
		Clear All Parameters		⊙	⊙	
		Check Device Duplication of Global Label		⊙	⊙	
		Device/Label Automatic-Assign Setting		⊙	⊙	
		Block password settings		⊙	⊙	
		Confirm Memory Size		⊙	△	(*1)
		Merge Data		⊙	⊙	
		Set TEL Data/Connect via Modem		×	×	
		Logging Configuration Tool		×	×	
		Ethernet Adapter Module Configuration Tool		×	×	
		Built-in I/O Module Tool		×	×	
		Check Intelligent Function Module Parameter		×	×	
		Intelligent Function Module Tool		×	×	
	Predefined Protocol Support Function		×	×		
	Language Selection		⊙	⊙		
	Profile Management		×	×		
	Key Customize		⊙	⊙		
	Options		⊙	⊙		
Window		Cascade	⊙	⊙		
		Tile Vertically	⊙	⊙		
		Tile Horizontally	⊙	⊙		
		Arrange Icons	⊙	⊙		
		Close All	⊙	⊙		
		(Switch to other window)	⊙	⊙		
		Other Window	⊙	⊙		
Help		GX Works2 help	⊙	⊙		
		Operating Manual	⊙	⊙		
		Connection to MITSUBISHI ELECTRIC FA Global Website	⊙	⊙		
		About	⊙	⊙		

(*1) While the online calculation is specified, free capacity may not be calculated correctly when the user safety sequence is connected.

Refer to "5.5.12 Checking Data Size" for details.

5.3.2 Function Support Status (Label Setting)

◎ : Supported; △ : Supported with restrictions; × : Not supported

Function	Menu	Sub menu	Machine sequence	User safety sequence	Remarks	
Edit	Delete		◎	◎		
	Select All		◎	◎		
	New Declaration (Before)		◎	◎		
	New Declaration (After)		◎	◎		
	Delete Row		◎	◎		
	Read from CSV File		◎	◎		
	Write to CSV File		◎	◎		
	System Label		×	×		
	Sort		Class	◎	◎	
			Label name	◎	◎	
			Data type	◎	◎	
			Constant	◎	◎	
			Device	◎	◎	
			Address	×	×	
			Comment	◎	◎	
Remarks	◎	◎				
Unused label list			◎	◎		

5.3.3 Function Support Status (Device Comments)

◎ : Supported; △ : Supported with restrictions; × : Not supported

Function	Menu	Sub menu	Machine sequence	User safety sequence	Remarks	
Edit	Delete		◎	◎		
	Select All		◎	◎		
	Import from Sample Comment		Special Relay/Special Register	◎	◎	
			Intelligent Function Module	×	×	
	Clear All (All Devices)			◎	◎	
	Clear All (All Displayed Devices)			◎	◎	
	Read from CSV File			◎	◎	
	Write to CSV File			◎	◎	
	Hide Bit Specification Information			◎	◎	
	Show Bit Specification Information			◎	◎	
	Cut The Range including Hidden Bit Specification Information			◎	◎	
	Copy The Range including Hidden Bit Specification Information			◎	◎	
	Paste The Range including Hidden Bit Specification Information			◎	◎	

5.3.4 Function Support Status (Ladder Diagram)

⊙ : Supported; △ : Supported with restrictions; × : Not supported

Function	Menu	Sub menu	Machine sequence	User safety sequence	Remarks	
Edit	Continuous Paste		⊙	⊙		
	Delete		⊙	⊙		
	Restore After Ladder Conversion		⊙	⊙		
	Insert Row		⊙	⊙		
	Delete Row		⊙	⊙		
	Insert Column		⊙	⊙		
	Delete Column		⊙	⊙		
	NOP Batch Insert		⊙	⊙		
	NOP Batch Delete		⊙	⊙		
	Edit Line		⊙	⊙		
	Delete Line		⊙	⊙		
	Change TC Setting		⊙	⊙		
	Ladder Edit Mode	Read Mode		⊙	⊙	
		Write Mode		⊙	⊙	
	Ladder Symbol	Open Contact		⊙	⊙	
		Close Contact		⊙	⊙	
		Open Branch		⊙	⊙	
		Close Branch		⊙	⊙	
		Coil		⊙	⊙	
		Application Instruction		⊙	⊙	
		Vertical Line		⊙	⊙	
		Horizontal Line		⊙	⊙	
		Delete Vertical Line		⊙	⊙	
		Delete Horizontal Line		⊙	⊙	
		Pulse Contact Symbol		△	△	Rising/Falling Pulse Close Branch (OR) are unavailable
		Invert Operation Results		⊙	⊙	
		Operation Result Rising Pulse		⊙	⊙	
		Operation Result Falling Pulse		⊙	⊙	
	Inline Structured Text		×	×		
	Edit FB Instance		⊙	⊙		
	Documentation	Device Comment		⊙	⊙	
		Statement		⊙	⊙	
		Note		⊙	⊙	
		Statement/Note Batch Edit		⊙	⊙	
	Easy Edit	Connect Line to Right-Side Symbol		⊙	⊙	
		Connect Line to Left-Side Symbol		⊙	⊙	
		Enter/Delete HLine Rightward		⊙	⊙	
		Enter/Delete HLine Leftward		⊙	⊙	
		Enter/Delete VLine Downward		⊙	⊙	
		Enter/Delete VLine Upward		⊙	⊙	
Switch Open/Close Contact			⊙	⊙		
Switch Statement/Note Type			⊙	⊙		
Instruction Partial Edit			⊙	⊙		
Edit List for Ladder Block		⊙	⊙			
Read from CSV File		⊙	⊙			
Write to CSV File		⊙	⊙			

⊙ : Supported; △ : Supported with restrictions; ×: Not supported

Function	Menu	Sub menu	Machine sequence	User safety sequence	Remarks	
Find/Replace	Change Module I/O No.		×	×		
	Switch Statement/Note Type		⊙	⊙		
	Line Statement List		⊙	⊙		
	Jump		⊙	⊙		
	Jump to Next Ladder Block Start		⊙	⊙		
	Jump to Previous Ladder Block Start		⊙	⊙		
	Next Device		⊙	⊙		
	Next Coil		⊙	⊙		
	Back		⊙	⊙		
View	Comment		⊙	⊙		
	Statement		⊙	⊙		
	Note		⊙	⊙		
	Display Lines of Monitored Current Value		⊙	⊙		
	Display Format for Device Comment		⊙	⊙		
	Display Ladder Block	Hide Ladder Block		⊙	⊙	
		Display Ladder Block		⊙	⊙	
		Hide All Ladder Block		⊙	⊙	
		Display All Ladder Block		⊙	⊙	
	Device	Device		⊙	⊙	
		Batch Device Display		⊙	⊙	
		Cancel All Device Display		⊙	⊙	
	Display Compile Result		⊙	⊙		
	Zoom		⊙	⊙		
	Text Size	Bigger		⊙	⊙	
		Smaller		⊙	⊙	
	Open Other Window	Open Reference Window		⊙	⊙	
		Update Reference Window		⊙	⊙	
		Open Reference Source Window		⊙	⊙	
		Tile FB Horizontally		⊙	⊙	
Open Label Setting			⊙	⊙		
Open Zoom SFC Block			⊙	⊙		
Move SFC Cursor		×	×			
Open Instruction Help		⊙	⊙			

Note

(1) For details on the sequence program instructions available for CNC, refer to "PLC programming Manual".

5.3.5 Function Support Status (ST Language)

◎ : Supported; △ : Supported with restrictions; ×: Not supported

Function	Menu	Sub menu	Machine sequence	User safety sequence	Remarks
Edit	Delete		◎	×	
	List Operands		◎	×	
	Display Template		◎	×	
	Mark Template (Left)		◎	×	
	Mark Template (Right)		◎	×	
Find/Replace	Jump		◎	×	
	Bookmark	Toggle Bookmark	◎	×	
		Bookmark List	◎	×	
		Next Bookmark	◎	×	
		Previous Bookmark	◎	×	
	Delete All Bookmarks	◎	×		
Online	Monitor	Start Monitoring	◎	×	
		Start Monitor (bit type only)	◎	×	
View	Display Compile Result		◎	×	
	Zoom	Set Zoom Factor	◎	×	
		Increase Zoom	◎	×	
		Decrease Zoom	◎	×	
	Zoom Header/Body	Header	◎	×	
		Body	◎	×	
	Open Header		◎	×	

5.3.6 Function Support Status (Online)

⊙ : Supported; △ : Supported with restrictions; × : Not supported

Function	Menu	Sub menu	Machine sequence	User safety sequence	Remarks	
Online (common function)	Read from PLC		⊙	⊙		
	Write to PLC		⊙	⊙		
	Verify with PLC		⊙	⊙		
	Remote Operation		⊙	⊙		
	Redundant Operation		×	×		
	Password/Keyword	New		⊙	⊙	
		Delete		⊙	⊙	
		Disable		⊙	⊙	
	Soft Security Key Management		×	×		
	PLC Memory Operation	Format PLC Memory		⊙	⊙	
		Clear PLC Memory		×	×	
		Arrange PLC Memory		×	×	
	Delete PLC data		⊙	⊙		
	PLC user data		×	×		
	Export to ROM Format		⊙	×		
	Program Memory Batch Download		×	×		
	Latch Data Backup		×	×		
	PLC Module Change		×	×		
	Set Clock		×	×		
	Register/Cancel Display Module Menu		×	×		
	Monitor	Monitor Mode		⊙	⊙	
		Monitor (Write Mode)		⊙	⊙	
		Start Monitoring (All Windows)		⊙	⊙	
		Stop Monitoring (All Windows)		⊙	⊙	
		Start Monitoring		⊙	⊙	
		Stop Monitoring		⊙	⊙	
		Change Value Format (Decimal)		⊙	⊙	
		Change Value Format (Hexadecimal)		⊙	⊙	
		Device/Buffer Memory Batch		⊙	⊙	
		Program List		×	×	
		Interrupt Program List		×	×	
		Change Instance (Function Block)		⊙	⊙	
SFC All Block Batch Monitoring			×	×		
SFC Auto Scroll			×	×		
Watch		Start Watching		⊙	⊙	
	Stop Watching		⊙	⊙		
	Insert Next Object		⊙	⊙		
	Display Format of Bit Device		⊙	⊙		
	Register to Watch		⊙	⊙		
Local Device Batch Read + Save CSV		×	×			
Online (Ladder Diagram)	Monitor	Monitor Condition Setting	×	×		
		Monitor Stop Condition Setting	×	×		
		Entry Ladder Monitor	⊙	⊙		
		Delete All Entry Ladder	⊙	⊙		

5 Peripheral Development Environment (GX Works2)

5.3 GX Works2 Functions Available for Mitsubishi Electric CNC

⊙ : Supported; △ : Supported with restrictions; × : Not supported

Function	Menu	Sub menu	Machine sequence	User safety sequence	Remarks	
Debug (common function)	Modify Value		△	△	Buffer memory is unavailable.	
	Forced Input Output Registration/Cancellation		×	×		
	Device Test with Execution Condition		×	×		
	SAMPLING TRACE	Open Sampling Trace	⊙	⊙		
	Scan Time Measurement		×	×		
Diagnosis (common function)	PLC diagnostics		⊙	⊙		
	Ethernet Diagnostics		×	×		
	CC IE Control Diagnostics		×	×		
	CC IE Field Diagnostics		×	×		
	MELSECNET Diagnostics		×	×		
	CC-Link Diagnostics		×	×		
	Sensor/Device Monitor		×	×		
	System Monitor		×	×		
Online Module Change		×	×			
Edit (function for verification result)	Write to CSV File		⊙	⊙		
Find/Replace (function for verification result)	Next Mismatch		⊙	⊙		
	Previous Mismatch		⊙	⊙		
View (function for verification result)	Return to Result List		⊙	⊙		
	Close Detail Result		⊙	⊙		
	Close All Detail Result		⊙	⊙		
View (function for executing sampling trace)	Result Position	Move to Trigger Point	⊙	⊙		
	Switching Display Items	Device		⊙	⊙	
		Address		×	×	
		Comment		⊙	⊙	
		Data type		⊙	⊙	
		Radix		⊙	⊙	
	Timing Chart Scale	Narrow Scale		⊙	⊙	
		Wide Scale		⊙	⊙	
	Trend Graph Scale	Narrow Scale		⊙	⊙	
		Wide Scale		⊙	⊙	
		Initial Display		⊙	⊙	
Additional Information	Time		⊙	⊙		
	Program Name		×	×		
Debug (function for executing sampling trace)	Sampling Trace	Open Sampling Trace	⊙	⊙		
		Trace setting	⊙	⊙		
		Start Trace	⊙	⊙		
		Stop Trace	⊙	⊙		
		Execute Manual Trigger	⊙	⊙		
		Register Trace	⊙	⊙		
		Forced Execution Registration Effective	×	×		
		Export CSV Data	⊙	⊙		
		Read from PLC	⊙	⊙		
		Write to PLC	×	×		
		Delete All Data	⊙	⊙		

5.3.7 Function Support Status (NC Special Functions)

◎ : Supported; △ : Supported with restrictions; ×: Not supported

Function	Menu	Sub menu	Machine sequence	User safety sequence	Remarks
Multi-project			◎	×	

5.4 Preparation

5.4.1 Installing Tools

In the PLC development environment for this CNC, the tools are assumed to be used on Windows PC. Install tools for Windows PC.

For details of GX Works2 installation procedure, refer to "GX Works2 Installation Instructions".

When GX Works2 is installed, GX Developer is automatically installed as well.

5.4.2 Preparing Ethernet Communication

Prepare Ethernet communication as follows. For details, refer to each instruction manual.

- (1) Check the IP address of the CNC unit
- (2) Check the setting for prohibiting connection from GX Developer/GX Works2 on the CNC unit
- (3) Set the IP address of the personal computer
- (4) Connect the Ethernet cable
- (5) Set connection destination on GX Works2

5.4.2.1 Checking IP address of CNC unit

Check the IP addresses of the CNC unit. The IP addresses are specified in the following parameters.

Base common parameter	Item	Description	Setting example
#1926	Global IP address	CNC unit IP address for external sources	192.168.200.1
#1927	Global Subnet mask	Subnet mask of #1926	255.255.255.0

This example uses "192.168.200.1", the initial value after SRAM clear.

5.4.2.2 Checking CNC unit setting prohibiting connection from GX Developer/GX Works2

Check the setting on the CNC unit that prohibits connection from GX Developer and GX Works2. The restriction is set with the following parameter. When the parameter is set in the way that prohibits connection from GX Developer and GX Works2, connection from GX Works2 is blocked.

Base common parameter	Item	Description	Setting range
#11094	GX Restriction	Select whether to block connection from GX Developer/GX Works2	0: Allow the connection 1: Block the connection

5.4.2.3 Setting IP Address of Personal Computer

Set the IP address of the personal computer that runs GX Works2 within the same range of subnet mask as that of the CNC unit.

In the case of the above mentioned "Confirming IP Address of the CNC Unit", the address should be selected from the range between "192.168.200.1" and "192.168.200.254", excluding "192.168.200.1". When other CNCs and devices are connected to the same network, ensure that their addresses are not duplicated.

5.4.2.4 Connecting the Ethernet Cable

Connect the Ethernet cable to the connector LAN1 (or LAN) of the control unit. If the connector is already connected, connect the cable to the HUB of the connection target, etc.

5.4.2.5 Setting Connection Destination

The connection target must be specified before performing online operations from GX Works2 to the CNC controller.

The following TCP connection method is supported when connecting with Ethernet.

[TCP protocol: Connection type]

Used with typical networks. TCP is highly reliable (it requests re-transmission when data are lost), but not optimized for timely delivery because of a large volume of communication it handles.

Start the setting screen by the following operation in the navigation window on GX Works2.

Select [Connection Destination], then double-click [Current Connection].

■ For the machine sequence

Set the following items in the order of the list.

Item	Setting	Remarks
PC side I/F	Ethernet Board	
Network No.	1	(*1)
Station No.	1	(*1)
Protocol	TCP	(*1)
PLC side I/F	Ethernet Module	
Module name	QJ71E71	(*2)
Station No.	1	(*2)
IP address	IP address of CNC	(*2)
IP Input Format	DEC.	(*2)
Station No. <-> IP information	Automatic Response System	(*2)
Other Station Setting	Other Station (Single Network)	
Check at communication time (sec.)	Arbitrary time (approximately 10 seconds and longer)	(*3)
Retry Times	0	(*3)
Network Communication Route Detailed setting of Ethernet		
	Access to Ethernet module set on PCL side I/F	(*4)

- (*1) Double-click [Ethernet Board] to display the setting item.
- (*2) Double-click [Ethernet Module] to display the setting item.
- (*3) Double-click [Other Station (Single network)] to display the setting item.
- (*4) Double-click [Ethernet] to display the setting item.

[Transfer Setup Connection 1 screen]

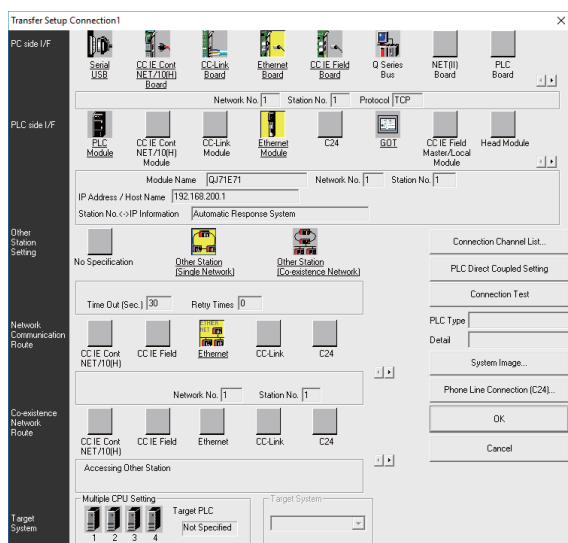

When the above setting is completed, press [Connection Test].

If connection is successful, the message "Connected with Q26UDHCPU" is displayed with the multi-CPU connection status below the message. This indicates the connection status of each project.

■ **For user safety sequence**

Set the following items in the order of the list.

Item	Setting	Remarks
PC side I/F	Ethernet Board	
Network No.	1	(*1)
Station No.	1	(*1)
Protocol	TCP	(*1)
PLC side I/F	CPU unit	
CPU mode	QCPU (Q mode)	(*2)
Ethernet: direct port connection and connection via hub selection	Connection via hub	(*2)
IP address	IP address of CNC	(*2)
IP Input Format	DEC.	(*2)
Other Station Setting	No other station designated	
Check at communication time (sec.)	Arbitrary time (approximately 10 seconds and longer)	(*3)
Retry Times	0	(*3)
Multi CPU		
	Select the first machine for the user safety sequence 1. Select the first machine for the user safety sequence 2.	

(*1) Double-click [Ethernet Board] to display the setting item.

(*2) Double-click [Ethernet Module] to display the setting item.

(*3) Double-click [Other Station (Single network)] to display the setting item.

[Transfer Setup Connection 1 screen]

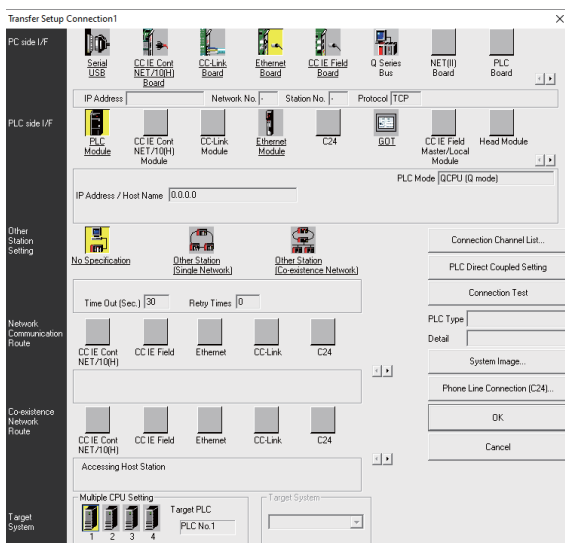

When the above setting is completed, press [Connection Test].

If connection is successful, the message "Connected with Q26UDHCPU" is displayed with the multi-CPU connection status below the message. This indicates the connection status of each project.

5.5 Common Items

5.5.1 Cautions Before Development

Before developing sequence programs using GX Works2, note the following.

Always observe the following precautions during work.

PLC type selection

The PLC type must be set when newly creating programs, etc. When prompted to set PLC type by GX Works2, select the following CPU type. If other types are selected, the transfer of sequence programs to a CNC controller fails with an error.

Note

(1) Select "Q26UDH" as CPU type.

Device settings

The number of devices must always be set when developing the sequence program for the CNC controller. If a sequence program is developed without setting the values as described later, the sequence program is not transferred to a CNC controller properly.

Note

(1) Always set the number of devices.

PLC Instructions

MELSEC-specific PLC instructions cannot be used in developing sequence programs for CNC controllers. The formats of some instructions have been changed. For details, refer to "PLC Programming Manual".

Note

(1) MELSEC-specific PLC instructions cannot be used.

Saving the sequence program

Sequence programs transferred from GX Works2 or built-in PLC (built-in edit function) to a CNC controller are stored in temporary storage. Data in temporary storage are cleared at power OFF. (The sequence program stored in the ROM in the CNC comes into effect at the next power ON.)

To retain the sequence programs transferred to the CNC controller after the next power ON, write them to the ROM in the CNC

Note

(1) Sequence programs not saved in the ROM in the CNC are not retained after power OFF.

Use of array labels

When devices/labels are used as indexes for array labels, set the PLC bit selection parameter "#6471/bit1" to "1". At this time, the number of devices of the index register Z is 10 points (Z0 to Z9). When a Z10 or later device is used, the transfer of sequence programs to the NC controller fails with an error.

Note

(1) When devices/labels are used as indexes for array labels, set the parameter "#6471/bit1" to "1". Do not use Z10 or later devices.

5.5.2 Multi-project Function

Multiple-CPU system configuration of MELSEC PLC is implemented in CNC. This function divides a project by machine sequence to manage and start multiple divided projects independently on one CNC.

For details, refer to "PLC Programming Manual".

The multi-project function is not available for the user safety sequence.

5.5.2.1 Setting Multi-project

To enable multi-project, set the multi-project setting parameters as follows and restart the CNC.

M01	PROJECT1					
MAIN	PROJECT SETTING					
Please set the parameters for the operation of the multi-project.						
MAX PROJECT No.	01	02	03	04	05	06
LIST						
PROJECT No.	01	02	03	04	05	06
PROJ. RATIO (%)	25	25	25	25		
EXECUTE PROJECT	ON	ON	ON	OFF		
EXE.ORDER	3	1	2	4		
←						
MAX PROJECT No.	LIST	SET				CLOSE

5.5.2.2 Switching Projects to Access

Set which projects in the CNC to access. If not set, the access destination is project 1. The number of projects that can be connected to depends on the setting of Multi-project parameter "Maximum project No. parameter".

■ How to connect to projects 1 to 4

The figure below shows how to connect to projects 1 to 4.

[Screen for selecting connection target]

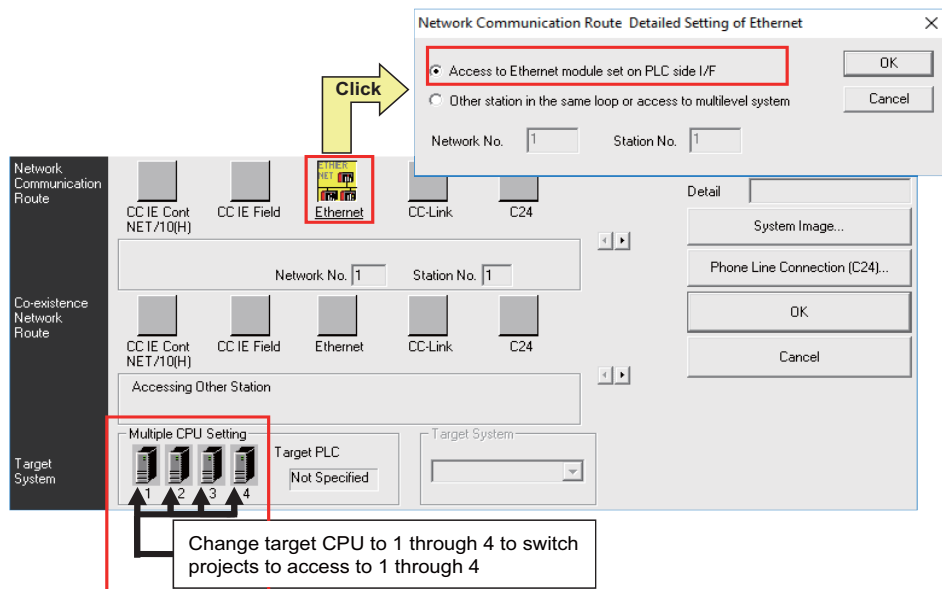

Setting items	Setting	Remarks
Network Communication Route	Ethernet	
	Access to the Ethernet module specified on PCL side I/F	(*1)
Multi CPU setting		
	Machine 1 to 4	Switch to multi-project 1 to 4

(*1) Double-click [Ethernet] to display the setting item.

■ How to connect to projects 5 and 6

The figure below shows how to connect to projects 5 and 6.

[Screen for selecting connection target]

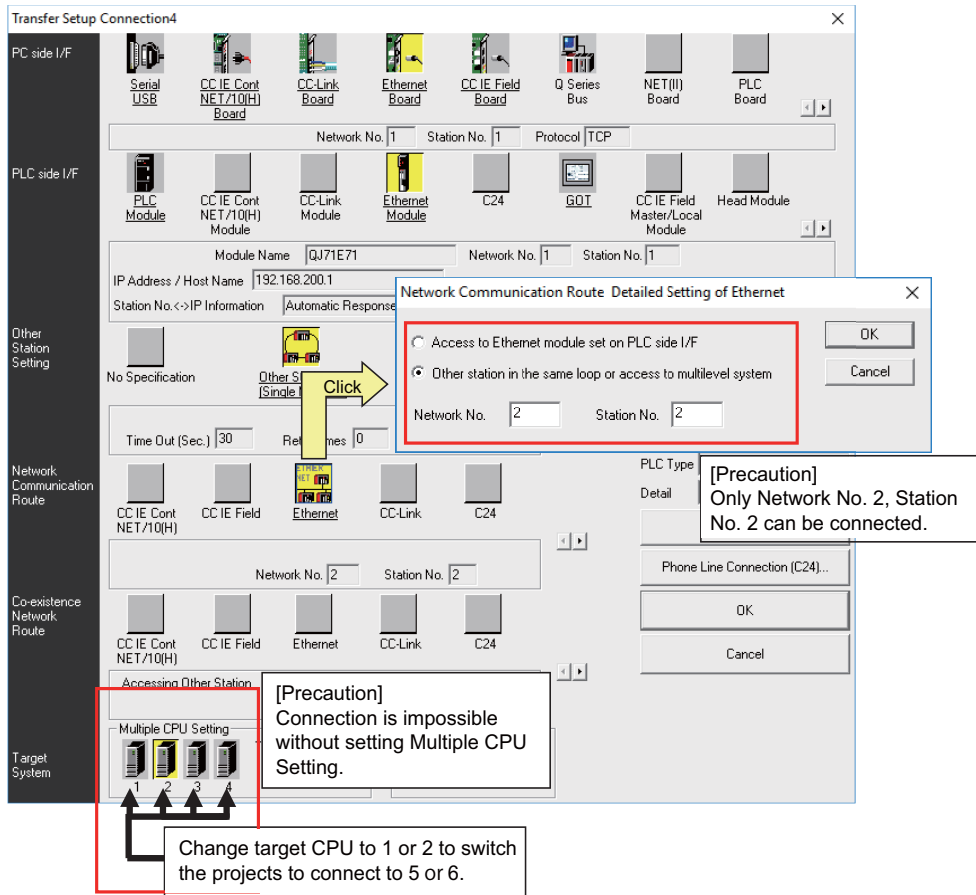

Setting items	Setting	Remarks
Network Communication Route	Ethernet	
Access to other stations in the same loop or multi-tier system		(*1)
Network No.	2	
Station No.	2	
Multi CPU setting		
CPU 1 and 2	Switch to multi-project 5 and 6	

(*1) Double-click [Ethernet] to display the setting item.

5.5.3 PLC Data Storage Area

M8V series CNC stores PLC data in the ROM in CNC. The storage is configured as follows.

(Refer to "PLC Programming Manual" for data area configuration and size.)

For the user safety sequence, refer to "M800/M80 Series Smart safety observation Specification manual".

Control information
Sequence program storage area
Control information
Storage area for files other than sequence programs e.g. Messages, device comments

5.5.3.1 Executing Sequence Program

When executed, a sequence program transferred from GX Works2 or built-in PLC (built-in edit function) is processed as follows.

■ At the power ON

Data are transferred from the ROM in the CNC to the execution area in the PLC processor via temporary storage (RAM in the CNC) before being executed.

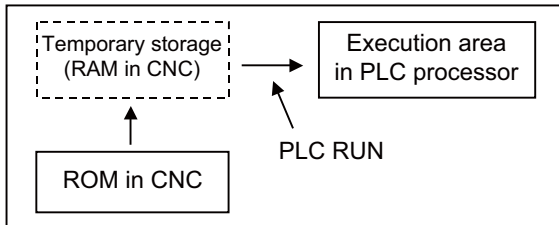

The mode that prevents PLC RUN from being executed can be activated by the following operation.

- Set the rotary switch 2 of the CNC unit to "1". ("0" is set as default.)

■ During PLC development

PLC data transferred from GX Works2 or built-in PLC (built-in edit function) are first stored in the volatile RAM for temporary storage. After transferred to the execution area in the PLC processor prior to PLC execution, the sequence program is executed.

The PLC data in temporary storage (RAM in CNC) are not retained after the CNC is powered OFF. To retain the PLC data after power OFF, write the data to the ROM in the CNC. (Refer to "5.6.6 Writing Sequence Programs to ROM in CNC")

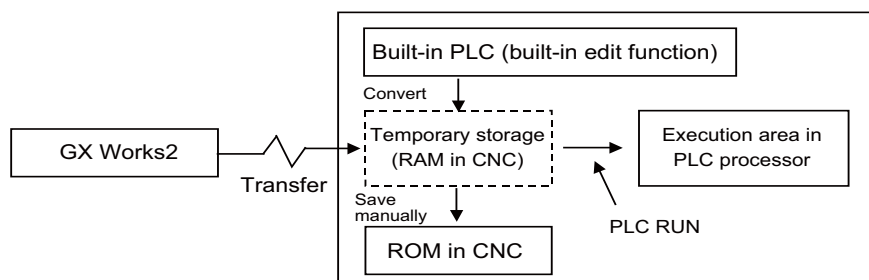

When a sequence program is transferred from the temporary storage area to the execution area, the program execution format is converted to that of the sequence program. Although the execution area of the PLC processor has twice the capacity of the temporary storage area, PLC cannot be executed if the capacity exceeds the allowable range.

When the PLC cannot be executed, reduce the number of steps of the sequence program.

5.5.3.2 Relationship between Areas in CNC and Storage Areas Selectable on GX Works2

This subsection describes the relationship between PLC data storage area in the CNC and the storage area selectable on GX Works2.

For details on what data can be stored in which area, refer to "PLC Programming Manual".

PLC data that can be saved from GX Works2	Memory selectable on GX Works2	PLC data storage area in CNC
Sequence programs Parameters	Program memory/device memory	Sequence program storage area/Temporary storage (RAM in CNC)
Device comments PLC messages Symbolic information (*1)	Program memory/device memory Memory Card (RAM)	Data storage area/Storage area (ROM in CNC)

(*1) Files written to CNC when simple projects (with labels) or structured projects are used.

5.5.3.3 Displaying Storage Area on GX Works2

The storage area available for the online functions can be specified as [Target Memory Setting] on each of the operation screens in GX Works2. Select [Program Memory/Device Memory] when not checking the available space and the number of steps for execution. When checking the available space in data storage area, select [Memory card(SRAM)]; when checking the number of steps for execution, select [Standard RAM].

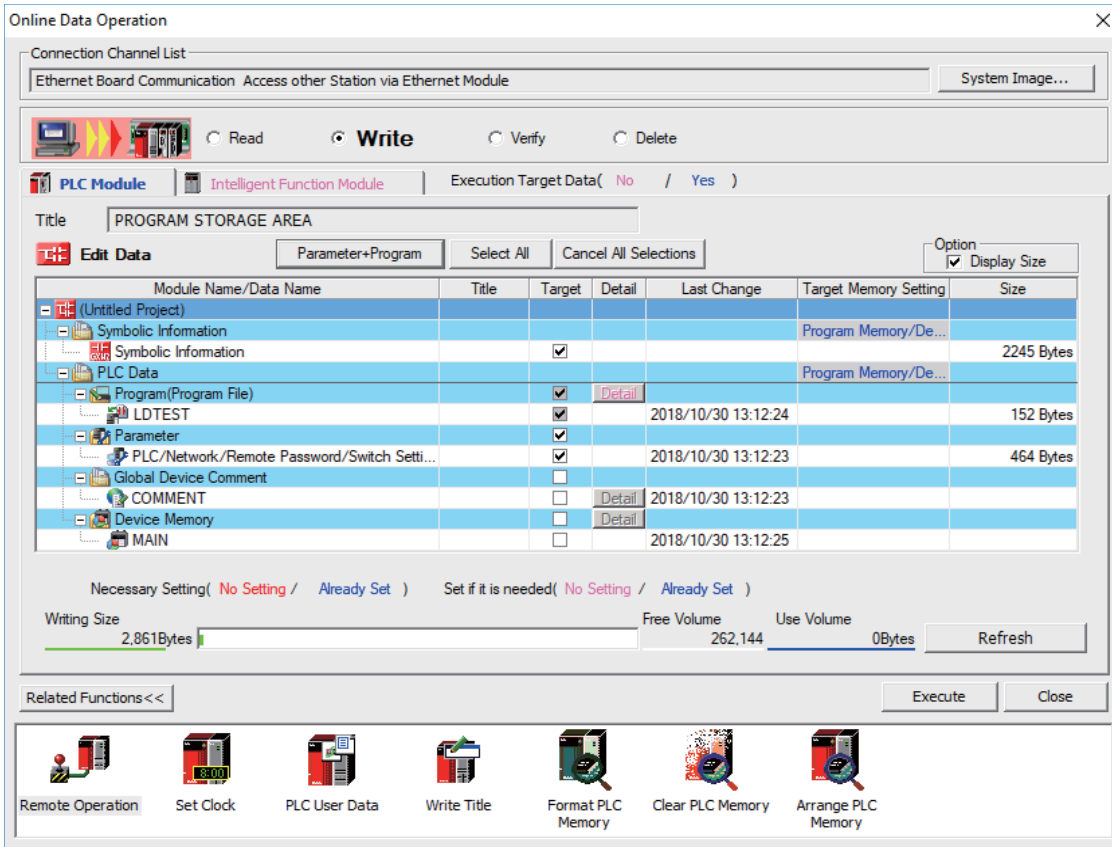

Click [Refresh] to display the available space in the area selected as [Target Memory Setting].

When [Target Memory Setting] is Program Memory/Device Memory:

The available space in storage area for sequence programs is displayed

When [Target Memory Setting] is Memory card (SRAM):

The available space in storage area for data is displayed

This table shows the relationship between the [Target Memory Setting] items and storage areas.

Target memory	Meaning in M8V series	Available space display
Program memory	Sequence program storage area (temporary storage (RAM in CNC))	Available space: Available space in storage area for sequence program
Device Memory		
Memory card (SRAM)	Data storage area (Storage area (ROM in CNC))	Available space: Available space in storage area for data
Memory card (Flash)	Not used (Not selectable)	
Memory card (ATA)	Not used (Not selectable)	
Standard RAM	Check number of steps for execution	Not used
Standard ROM	Not used (Not selectable)	

5.5.4 File Name

PLC-related data such as sequence programs and message data are managed and stored in categories inside this CNC as shown below. These data are also developed under each category.

⚠ CAUTION

Observe the following naming conventions for data files. Transferring data not adhering to these guidelines may confuse the CNC and lead to unintended results such as erasing sequence programs.

5.5.4.1 Naming Conventions for Sequence Programs, Parameters, and Device Comment Files

File naming conventions (sequence programs, parameters, device comments)

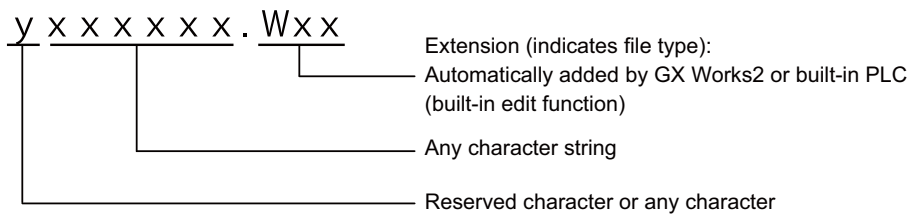

When saving data on GXWorks2 or on built-in PLC (built-in edit function), differentiate the data type with the file name. A file name can be up to 8 characters long and can contain half-width alphanumeric characters, hyphens (-), and underscores (_) (excluding extensions). The extension is automatically added to indicate the file type.

The first one character may be reserved to indicate the data type.

Note

- (1) If the first character of the file name is the following, the file name is reserved by the CNC.
- "H"
Do not use the file name in this combination.
- (2) Files of a structured project are named their program file name, not names of POU's (program blocks).

List of sequence programs, parameters, and device comments

	Data category	Data type	File name	Number of files storable	Remarks
1	Sequence programs (*4)	High-speed process	H+[Any character string].WPG	Total 120 programs (*2)	Execution type (scan) (*1)
		Main process	[Arbitrary character string].WPG		Execution type (scan) (*1)
		Initialization process	[Arbitrary character string].WPG		Execution type (initialization) (*1)
		Standby process	[Arbitrary character string].WPG		Execution type (wait/low-speed) (*1)
2	Parameter	PLC parameters	PARAM.WPA (fixed)	6 parameters (*2)	
		Network parameters			
3	Device comments	Common comment	COMMENT.WCD (fixed)	Total 80 comments (*2)(*3)	Common for all sequence programs
		Comment for each program	[Arbitrary character string].WCD		For sequence programs having same name

Any character string means a string of up to 8 one-byte alphanumeric characters, hyphens (-), and underscores (_).

- (*1) Execution type is a type of sequence program operation specified by parameters.
- (*2) The total number of projects when the multi-project function is active.
- (*3) The total number of files for device comments, messages, and symbolic information.
- (*4) Reserved words cannot be used in file names of data with labels.

5.5.4.2 File Name Rule for Message Data

There are two types of file naming conventions for message data, depending on the method for specifying the language. Although either method can be selected, method (2) is recommend, as it works with the language specification for the setting display screen.

For the user safety sequence, the message file cannot be used.

(Method 1) Specify bits 0-2 (3 bits) of bit selection parameter #6453 (Language selection method using only the PLC).

(Method 2) Specify with the display language selection parameter (Base specification parameter #1043 (Method linked with language selection on the setting and display screens)).

File naming convention (message data)

Method (1) **M N X x x x x x . W P G**

Any 6-character string (the first character is non-numeric)
 Number (1 digit)
 Reserved character

Method (2) **M N N x x x x x . W P G**

Any 5-character string
 Number (2 digits)
 Reserved character

The 6- or 5-character string above can contain half-width alphanumeric characters, hyphens (-), and underscores (_).
 The extension is automatically added to indicate the file type.
 The first character is reserved to indicate the data type.

The file name of the stored message file determines which method is valid.
 If there are both files meeting condition 1 and files meeting condition 2, method 1 is valid.

Condition 1: If the first 2 characters of the file name are "M + 1-digit number", method 1 is valid.
 Condition 2: If the first 3 characters of the file name are "M + 2-digit number", method 2 is valid.

Note

- (1) Files of a structured project are named their program file name, not names of POU's (program blocks).
- (2) When you input a reserved character or numeric characters, rename the program file.

Method 1

Language is selected by three bits (bit 0-2) of Bit selection parameter #6453; the number corresponds to the number in the message file name.

List of message file names in method 1

Data category	Bit selection parameter #6453 bit0 to bit2	Data type	File name	Number of files storable	Remarks
Message (Method 1)	0	1st language	M1Xxxxx.WPG	One file per language: 80 in total (*2)	Multiple files of the same language number cannot be stored even if the file names are different. If an attempt is made to save a file of the same language number, a dialog prompting for overwrite confirmation is displayed.
	1	2nd language	M2Xxxxx.WPG		
	2	3rd language	M3Xxxxx.WPG		
	3	4th language	M4Xxxxx.WPG		
	4	5th language	M5Xxxxx.WPG		
	5	6th language	M6Xxxxx.WPG		
	6	7th language	M7Xxxxx.WPG		
	7	8th language	M8Xxxxx.WPG		

- (*1) The "Xxxxxx" part of a file name consists of up to 6 one-byte alphanumerical characters, hyphen (-) and underline (_).
The third character X must be a non-numeric character. (To avoid being confused as method 2)
- (*2) When the multi-project function is active, one file for a language can be stored for each project.
The total number of projects when the multi-project function is active.
The total number of files for device comments+ messages+ and symbolic information.

■ Method 2

Language is specified with the language parameter #1043 on the setting and display screen, and the No. corresponds to the 2-digit No. used in message file name.

When there is no message file corresponding to the language parameter, the file to display English (M00xxxx.WPG) is referred to as the alternative file. Ensure that the message data file for alphabet display is stored.

List of message file names in method 2

Data category	Language parameter (Base specifications parameter #1043)	File name	Number of files storable	Remarks
Message (Method 2)	0 (English) (mandatory)	M00xxxx.WPG	One file per language: 80 in total (*1)	When there is no message file corresponding to the language parameter, the file for alphabet display (M00xxxx.WPG), if stored, is referred to as the alternative file. Multiple files of the same language number cannot be stored even if their file names ("xxxx" part) are different. If an attempt is made to save a file of the same language number, a dialog prompting for overwrite confirmation is displayed.
	1 (Japanese)	M01xxxx.WPG		
	11 (German)	M11xxxx.WPG		
	12 (French)	M12xxxx.WPG		
	13 (Italian)	M13xxxx.WPG		
	14 (Spanish)	M14xxxx.WPG		
	15 (Traditional Chinese)	M15xxxx.WPG		
	16 (Korean, Hangeul)	M16xxxx.WPG		
	17 (Portuguese)	M17xxxx.WPG		
	18 (Dutch)	M18xxxx.WPG		
	19 (Swedish)	M19xxxx.WPG		
	20 (Hungarian)	M20xxxx.WPG		
	21 (Polish)	M21xxxx.WPG		
	22 (Simplified Chinese)	M22xxxx.WPG		
Other than above (up to 99)	If the message for a corresponding No. exists, it is displayed. If not, the message of English file (M00xxxx.WPG) is displayed.			
Other than above (more than 100)	English (M00xxxx.WPG) is displayed.			

(*1) When the multi-project function is active, one data item per language can be stored for each project.

The total number of projects when the multi-project function is active.

The total number of files for device comments, messages and symbolic information.

■ Caution

- If the third character in the name of a stored file is a numeric character, the file may be recognized as method 2 (display language selection parameter), even if it is an existing method 1 file for old models.
(Example) "M1720V02.WPG", M750MESS.WPG", M65S-MES.WPG", etc.
- If file names contain the same number, the files are recognized as identical and overwritten even if the names contain different strings.
(Example) "M1TEST.WPG" and "M1JAPAN.WPG", M00ENG01.WPG" and "M00ENG02.WPG", etc.
- If the methods are different, files of similar file names are not recognized as identical, and not overwritten.
If there are both files meeting method 1 and files meeting method 2, method 1 is valid.
(Example) "M1TEST.WPG" and "M01TEST.WPG", M1JAPAN.WPG" and "M01JAPAN.WPG", etc.
- Files not meeting condition 1 or condition 2 are not recognized as message files. They are recognized as sequence program (ladder) files.
(Example) "M0TEST.WPG", M9MESS.WPG", M0-1TEST.WPG, "M-01ENG.WPG, "MM00ENG.WPG", etc.
- If reserved characters are used in the name of data file with labels, a compilation error occurs.
Include at least one non-numeric character in xxxxx.
(Example) "M00.WPG", M11000.WPG", M295.WPG.WPG", etc.

5.5.5 Creating Project

In GX Works2, PLC-related data such as sequence programs and message data are handled in units called "project". This section describes how to create project.

5.5.5.1 Project

A project is an assembly of sequence programs, device comments, PLC message data, and parameters. Those data are usually managed in project units organized by model or by version.

■ Overview of project

For the overview of project, refer to the following.

- ♦ 5.6.1 Overview of Simple Project
- ♦ 5.7.1 Overview of Structured Project

■ One project per GX Works2

Only one project unit can be edited on one GX Works2. When editing more than one project, start GX Works2 additionally.

■ Device comment

Comment type	Number of comments that can be created	Details
Global device comment	1	Device comment common to programs in a project
Language device comment	Same as the number of programs	Device comment set for each program Set the same name as program name.

■ The number of ladder files and PLC message files that can be handled in one GX Works2 project

Up to 124 ladder files and PLC message files in total can be handled in one project on GX Works2. (When an attempt is made to create the 125th file, an error occurs, and a file is not created.)

To handle more than 125 ladder files and PLC message files in total, perform either of the following operations for development.

- ♦ Create and manage a PLC message-dedicated project apart from sequence programs.
- ♦ Use the multi-project function to reduce the number of files per project to 124 or fewer.

5.5.5.2 Operating Procedures

Start the operation screen by the following operation on GX Works2.

[Project] -> [New]

Set the PLC series, PLC type, and project name, which are required to create a new project, in the following window.

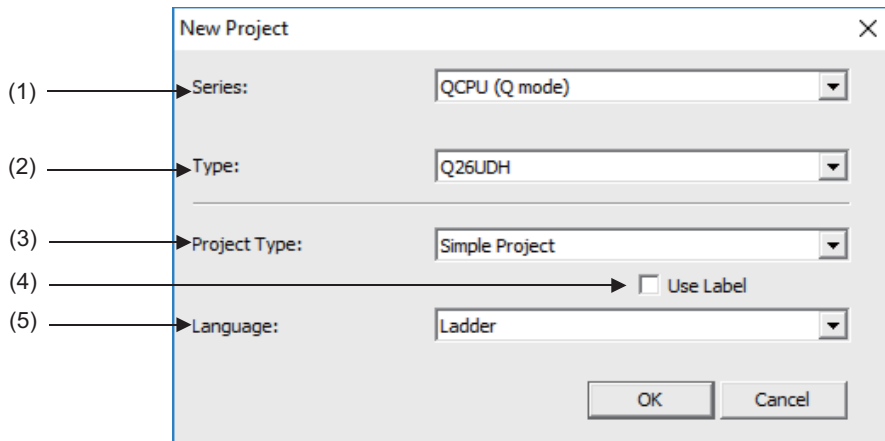

Set the following items, and press [OK] in the "New Project" window.

(1) Series

Set the series name of the PLC (Programmable controller). Select "QCPU (Q mode)" here.

(2) Type

Set the type of the PLC. Set "Q26UDH" here.

(3) Project type

Set the project type. To create a sequence program (without labels), select "Simple Project".

To create a sequence program (with labels), select "Simple Project" or "Structured Project".

To create a sequence program in ST language, select "Simple Project" or "Structured Project".

(4) Use Label

To create a sequence program (with labels), check the "Use Label" checkbox.

To use function blocks and labels, check the "Use Label" checkbox.

To use ST language in a simple project, check the "Use Label" checkbox.

Note

- ◆ Even when labels are used, the built-in PLC (built-in edit function) displays an actual unlabeled ladder (ladder with labels and functional blocks compiled).
- ◆ When "Structured Project" is selected, this setting becomes non-selectable. (Labels are used by default.)

(5) Language

Set the programming language. To create a sequence program (without labels, with labels), select "Ladder".

To create a sequence program in ST language, select "ST".

5.5.6 Writing Data to CNC Controller

To operate on the CNC controller the data created and edited by GX Works2, write them to the CNC controller. This section describes how to write data to the CNC controller.

For the user safety sequence, refer to "M800/M80 Series Smart safety observation Specification manual".

- (1) Start the operation screen by the following operation on GX Works2.

[Online] -> [Write to PLC]

- (2) Select the files to write, and click [Execute] on the following screen.

- To write individual files, select files to be written.
- To write parameters and sequence programs, click [Parameter+Program].
- To write all files, click [Select All].

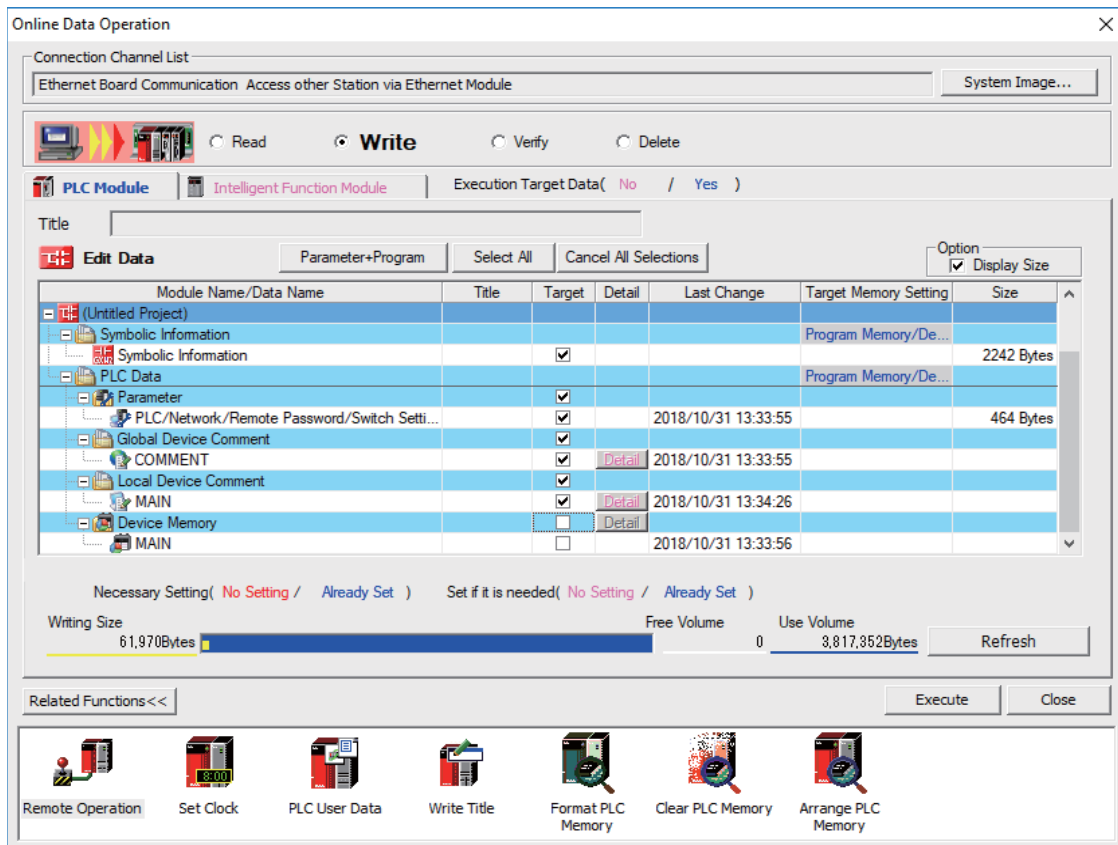

Note

- [Program Memory/Device Memory] is the only valid option for [Target Memory Setting].
- Since device memory cannot be written to the CNC controller, unselect the checkbox for device memory.
- If an attempt is made to remove the check from the parameter and to write sequence programs while PLC is running, the prompt "PLC is running. Do you want to force write of the files?" is displayed.
The CNC can only write during RUN from the [Compile] menu; when [Yes] is clicked, writing sequence programs fails with an error message.
When [No] is clicked, the message "Do you want to write to PLC after remote stop?" is displayed; click [Yes].

5.5.7 Reading Data from CNC Controller

Read data in the CNC controller to GX Works2 to edit them. This section describes how to read data from the CNC controller.

- (1) Start the operation screen by the following operation on GX Works2.
[Online] -> [Read from PLC]
- (2) Select the file to be read on the following screen, and click [Execute].
 - ◆ To read individual files, select files to be read.
 - ◆ To read parameters and sequence programs, click [Parameter+Program].
 - ◆ To read all files, click [Select All].

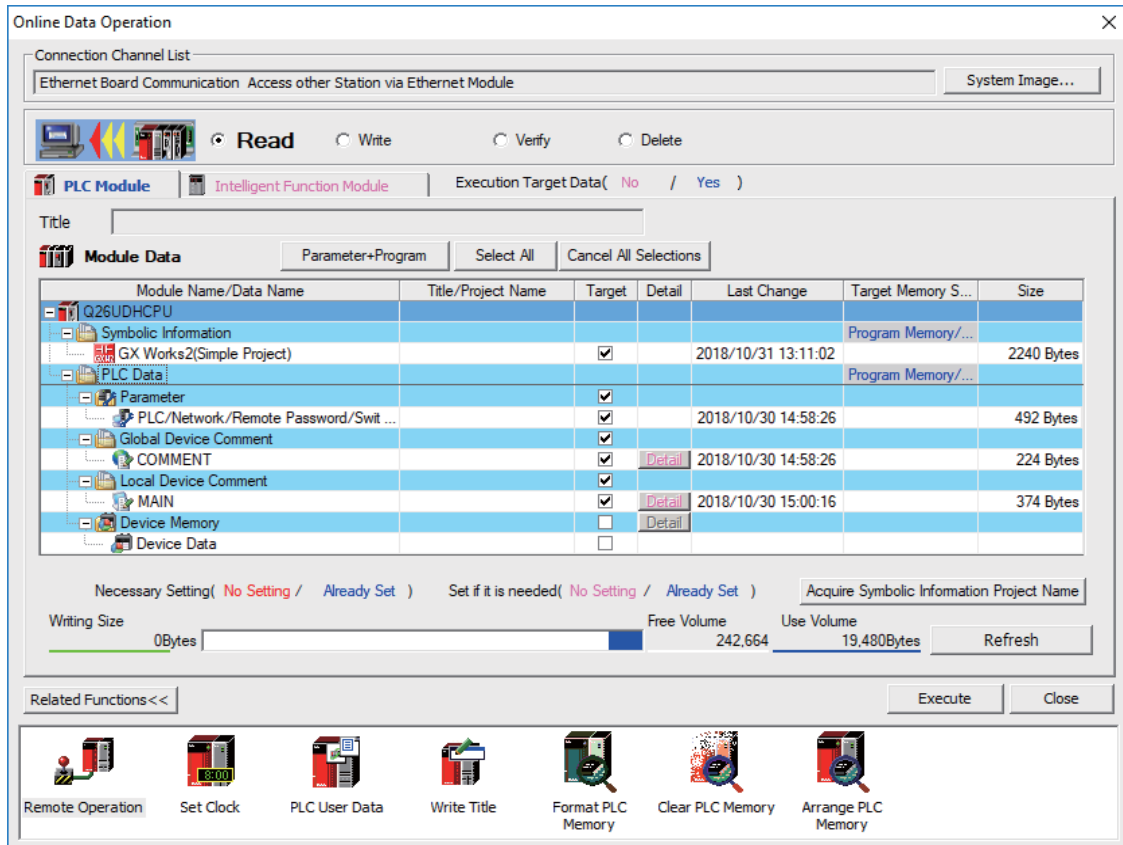

Note

- ◆ [Program Memory/Device Memory] is the only valid option for [Target Memory Setting].
- ◆ Device memory is not written on the CNC controller. Remove the check of "Device Memory".

5.5.8 Setting the Parameters

Set GX Works2 parameters when developing sequence programs for the CNC controller on GX Works2. The required parameter settings are shown below.

For details of each setting item, refer to "GX Works2 Operating Manual (Common)".

- ♦ Setting the Number of Device Points
- ♦ Setting the number of common pointers
- ♦ Setting the program execution order
- ♦ Setting the labels/comments of project

5.5.8.1 Parameter Setting Screen

(1) Displaying parameter setting screen

To open the parameter setting screen, display the project view on the navigation window by the following operation.

Expand the tree by double-clicking [Parameter], and double-click [PLC Parameter].

[Project] -> Double-click [Parameter] -> Double-click [PLC Parameter]

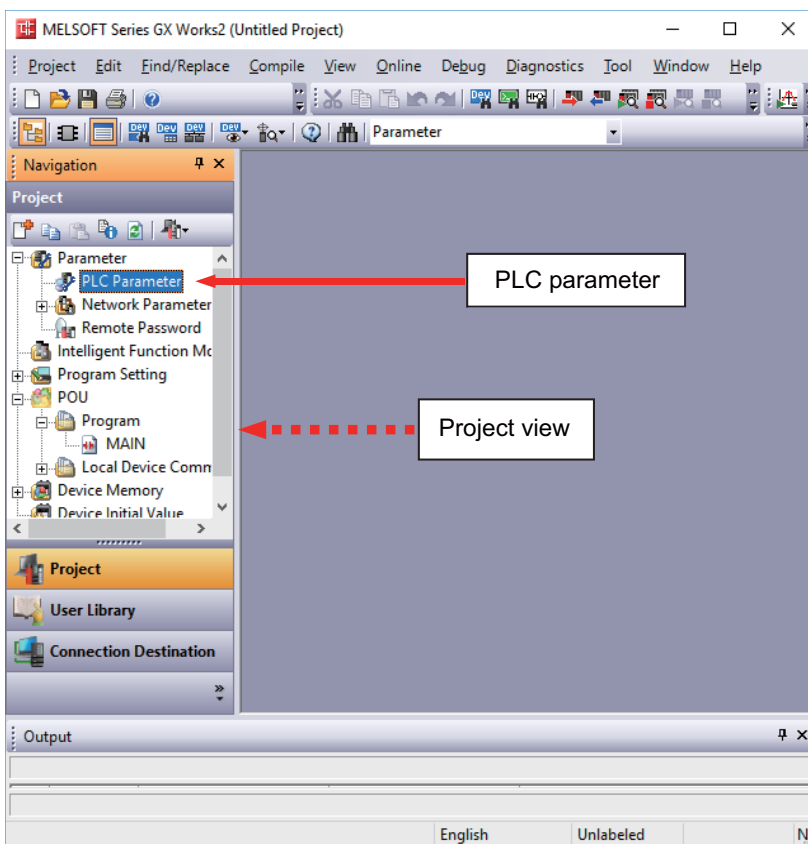

The above operation opens the following parameter setting screen. Tab names in red indicate that the initial values are set.

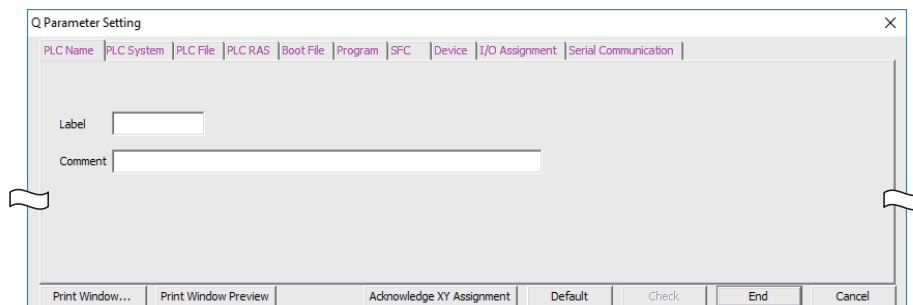

5.5.8.2 Setting the Number of Device Points

After creating an area (project) to manage sequence programs, set the number of the devices used in the project at first. This operation is required every time a new project is created.

For details on each setting item, refer to the "PLC Programming Manual".

Note

- Without this operation, an error occurs when sequence programs are downloaded to the CNC controller.

(1) Select [Device] tab.

Populate the device points in the parameter with the numbers of device points + common points that are set on the device setting screen in built-in PLC (built-in edit function). Setting wrong device points incurs an error. The range of devices that can be used in each project varies in multi-project environment.

(2) Enter the number of the devices, and click [End] on the following screen.

Enter the number of devices in the project currently connected to inside the red line indicated in the figure below. When all device points are set, press [End] to end editing.

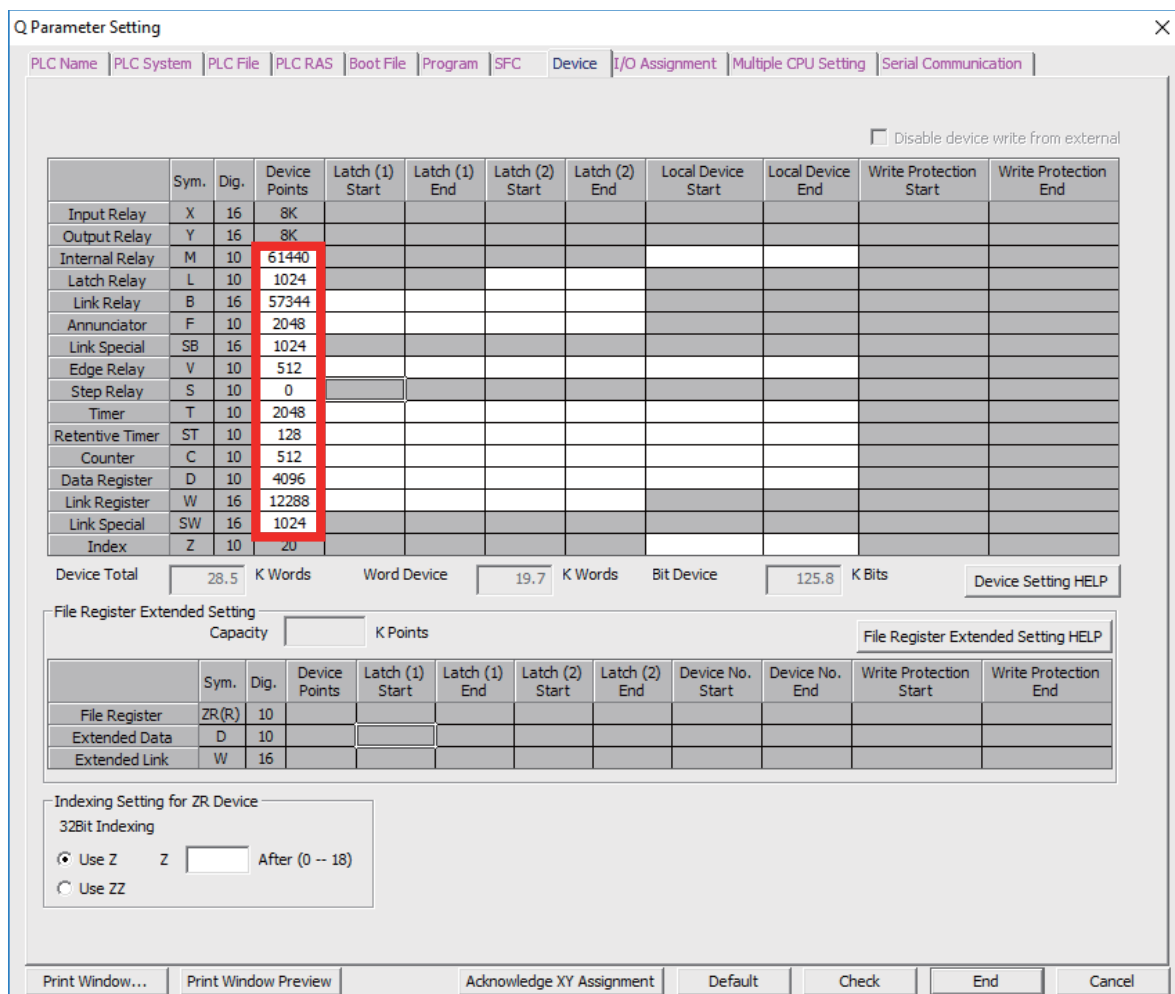

Note

- If the wrong number is set, downloading to the CNC controller fails with an error.

■ If the set values for devices are illegal

If there is a problem with the device setting value, the following error dialog will appear when writing the sequence programs to the CNC controller. Set the number of device points as explained above in this case.

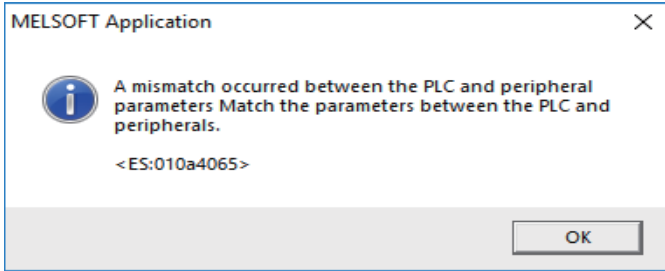

■ Setting example of the number of devices (Project 1)

The setting example of the number of devices for the project 1 is described below.

Populate the device setting parameter of GX Works2 with the sum of device points and device common points of project 1 set in built-in PLC (built-in edit function) as this example shows.

Q Parameter Setting

PLC Name | PLC System | PLC File | PLC RAS | Boot File | Program | SFC | Device | I/O Assignment | Multiple CPU Setting | Serial Communication

Disable device write from external

	Sym.	Dig.	Device Points	Latch (1) Start	Latch (1) End	Latch (2) Start	Latch (2) End	Local Device Start	Local Device End	Write Protection	Write Protection
Input Relay	X	16	8K								
Output Relay	Y	16	8K								
Internal Relay	M	10	27360								
Latch Relay	L	10	512								
Link Relay	B	16	20480								
Annunciator	F	10	1024								
Link Special	SB	16	512								
Edge Relay	V	10	256								
Step Relay	S	10	0K								
Timer	T	10	1024								
Retentive Timer	ST	10	64								
Counter	C	10	256								
Data Register	D	10	2736								
Link Register	W	16	8192								
Link Special	SW	16	512								
Index	Z	10	20								

Device Total 16.8 K Words

File Register Extended Setting Capacity

	Sym.	Dig.	Device Points
File Register	ZR(R)	10	
Extended Data	D	10	
Extended Link	W	16	

Indexing Setting for ZR Device 32Bit Indexing

Use Z Z After (0 -- 15) Use ZZ

PROJECT1

PARAM MULTI PROJECT PARAM. DEVICE SETTING

Please set the number of the device to be used.

	01	02	03	COMMON	TOTAL
M	17120	17120	16960	10240	61440
L	512	256	256	0	1024
B	20480	18432	18432	0	57344
F	0	0	0	2048	2048
SB	512	256	256	0	1024
V	256	128	128	0	512
S	0	0	0	0	0
T	1024	512	512	0	2048
ST	64	32	32	0	128
C	256	128	128	0	512
D	688	688	672	2048	4096
W	8192	2048	2048	0	12288
SW	512	256	256	0	1024
TOTAL	24.5K	1.2K	1.2K		

Annotations:

- Device setting window of built-in PLC built-in edit function
- [Example: M device] Set 27360 (= device points [17120] + device common points [10240]) in GX Works2 device setting parameters for project 1
- Setting for the number of device common points
- Set device points for project 1

Buttons: SET, CLOSE

Print Window... | Print Window Preview | Acknowledge XY Assignment | Default | Check | End | Cancel

GX Works2 Dialog box for parameter setting (Device setting)

5.5.8.3 Setting the Number of Common Pointer Points

In the following cases, set the pointer No. common to sequence programs.

- When creating the sequence programs with the multi-program method
- When creating sequence programs of main process with ST language

This operation is required every time a new project is created, and parameter files must be written to the CNC controller.

Note

- If no value is set to the common pointer No., "P1800" will be set.
When a simple project (with labels) or a structured project is newly created, or when "Project Type" is changed to any of the said project, "2048" is automatically set to "Common Pointer No." as the default value if its setting has been blank.

(1) Select [PLC System] tab.

(2) Set a numeric value in [Common Pointer No.], and click [End] on the following screen.

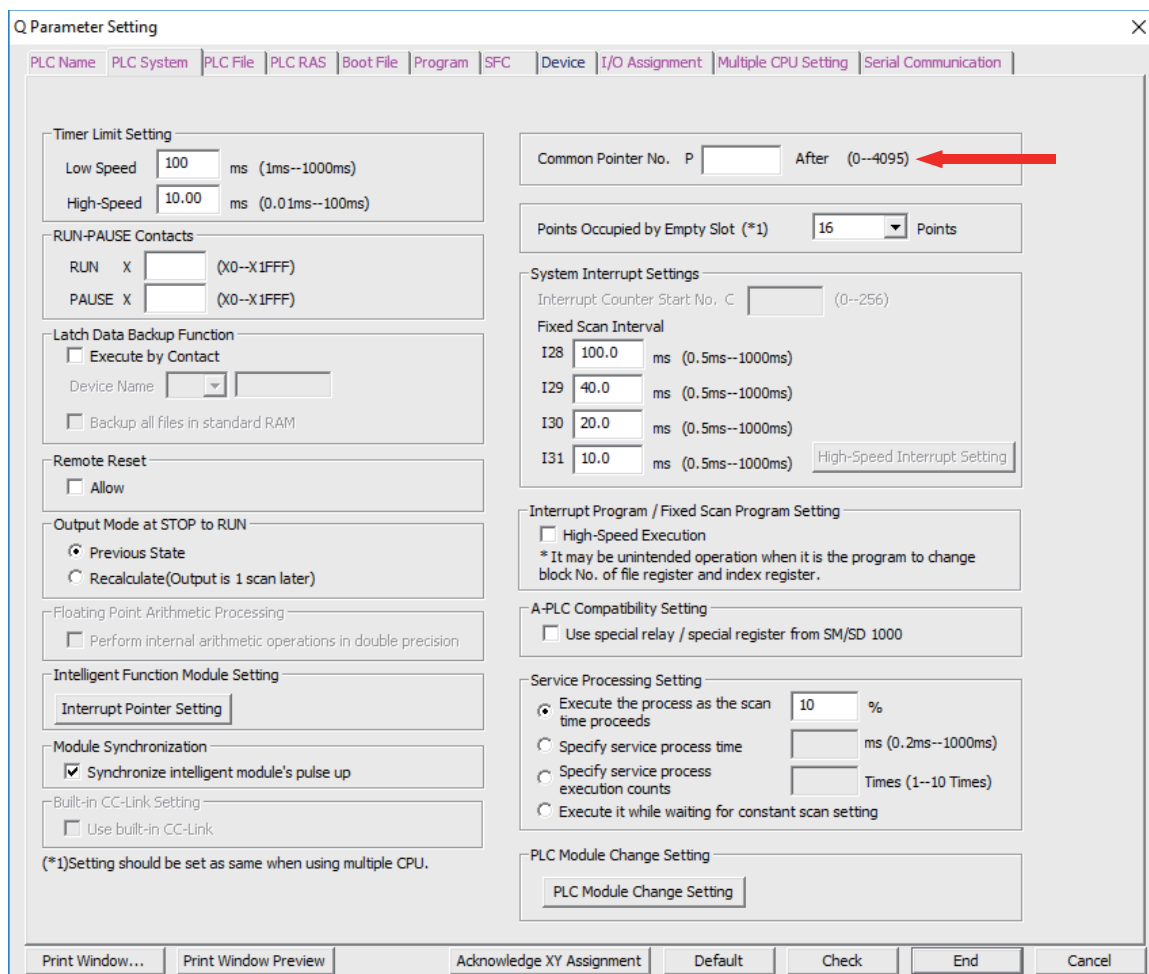

5.5.8.4 Setting the Program Execution Order

In the following cases, set the execution method and execution order to sequence programs.

- ♦ When creating the sequence programs with the multi-program method
- ♦ When creating sequence programs of main process with ST language

This operation is required before a sequence program is executed on the CNC controller, and parameter files must be written to the CNC controller.

Note

- ♦ If this operation is not completed when the multi-program method is in use or when creating sequence programs of main process with ST language, an error will occur on the RUN of sequence programs.

- (1) Select [Program] tab.
- (2) Select the name of the sequence program to be registered for execution from the program list on the left side of the following screen, and press [Insert]. Select the execution mode from the registered program list on the right side.
- (3) After registering all sequence programs to execute, click [End].

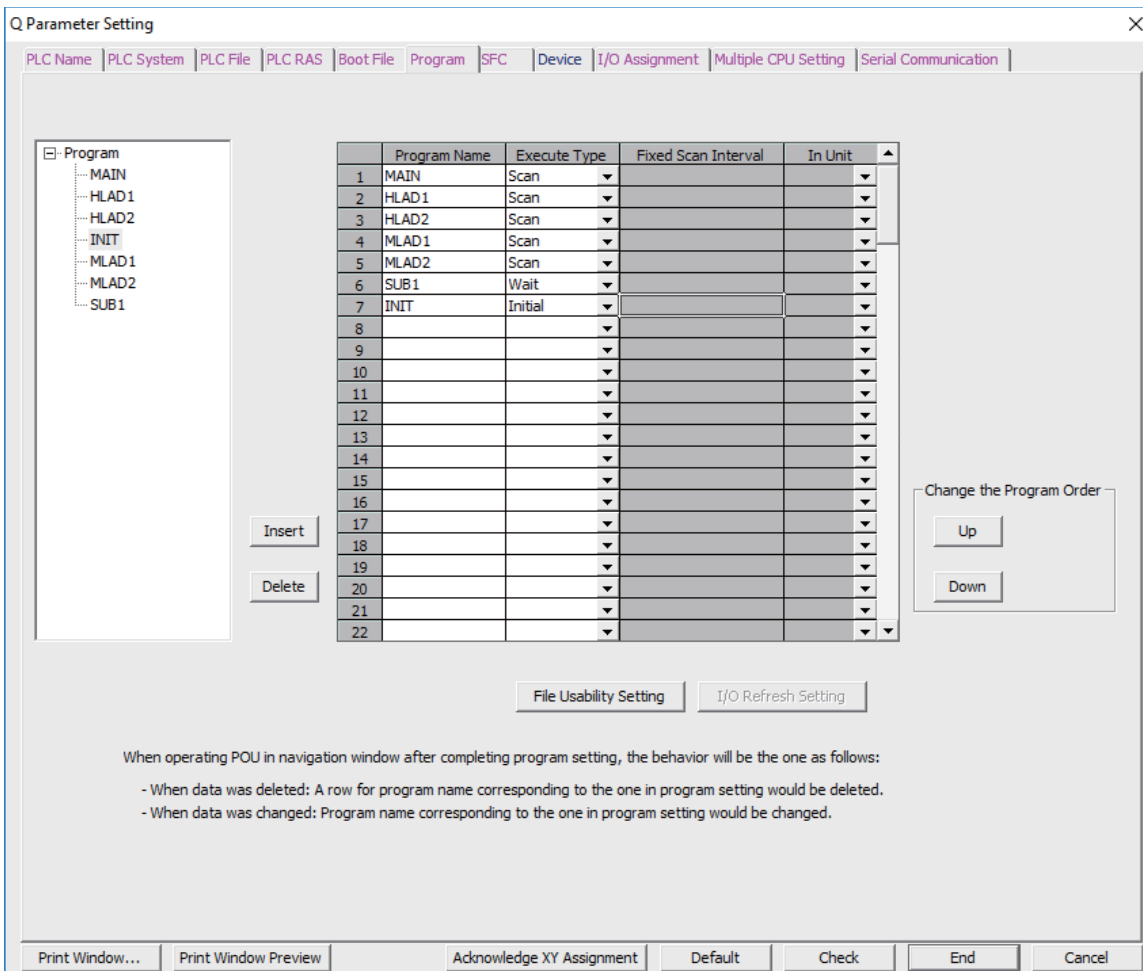

5.5.8.5 Setting Labels and Comments to Each Project

Labels and comments can be set for each project for clarification of the functions of the programs running on a project. Labels· comments can be set using GX Works2 or built-in PLC (built-in edit function).

- (1) Select [PLC Name] tab.
- (2) Input labels and comments, and click [End].

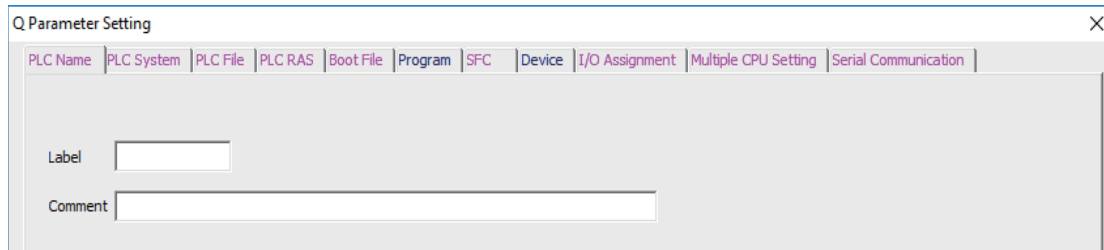

The following table describes the setting on the window above.

Parameter name	Tab name	Setting item	Number of characters	Setting
PC parameter	PC name	Label	Up to 10 one-byte characters or 5 two-byte characters	Label for project
		Comment	Up to 64 one-byte characters or 32 two-byte characters	Comment of project

5.5.8.6 Writing and Reading Parameters to CNC Controller

To create sequence programs in multi-program method, parameter files must be written to the CNC controller. They can be read from the CNC controller to be used on GX Works2.

They can be read and written in the same way as reading and writing sequence programs.

- (1) Start the operation screen by the following operation on GX Works2.

[Online] -> [Write to PLC]/[Read from PLC]

- (2) Select write/read parameter [PLC/Network/Remote Password/Switch Setting], and click [Execute] on the Online Data Operation screen.

Use [Remote Operation] under [Related Functions] to instruct the PLC to RUN or STOP.

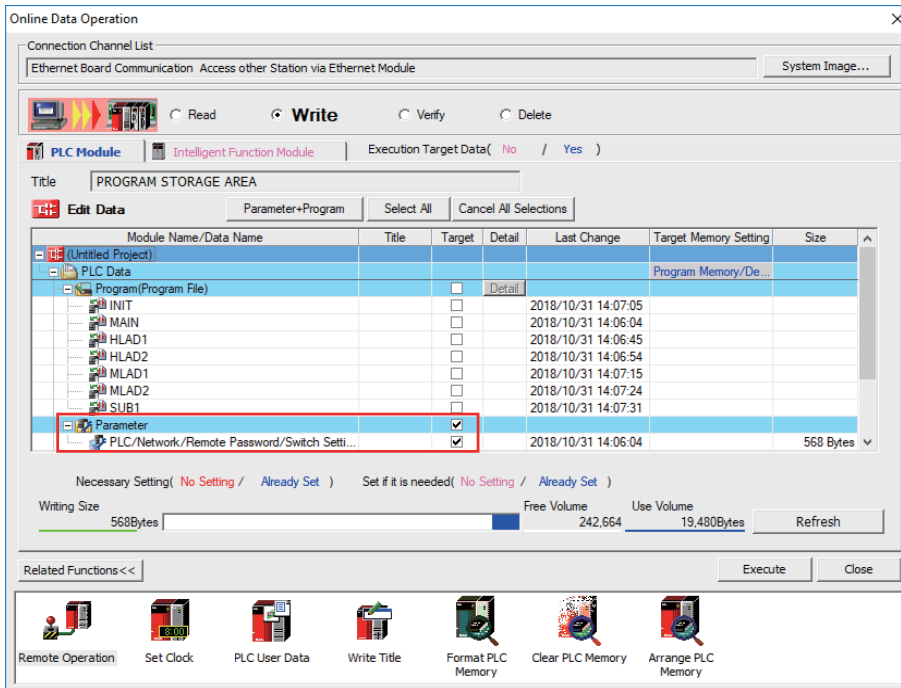

Note

- [Program Memory/Device Memory] is the only valid option for [Target Memory Setting].

5.5.9 Starting/Stopping PLC

Stop PLC on the CNC controller before writing sequence programs.

Confirmation of stop and restart is usually required before and after the operation that requires PLC stop. Stop and restart can be done in advance by the following operation.

5.5.9.1 Operation Procedure

(1) Start the operation screen by the following operation on GX Works2.

[Online] -> [Remote Operation]

(2) Set "STOP" or "RUN" in [Operation], and click [Execute] on the following screen. The status can be checked by the lighting of the "RUN" LED (ON: RUN, OFF: STOP) on the left side of the screen.

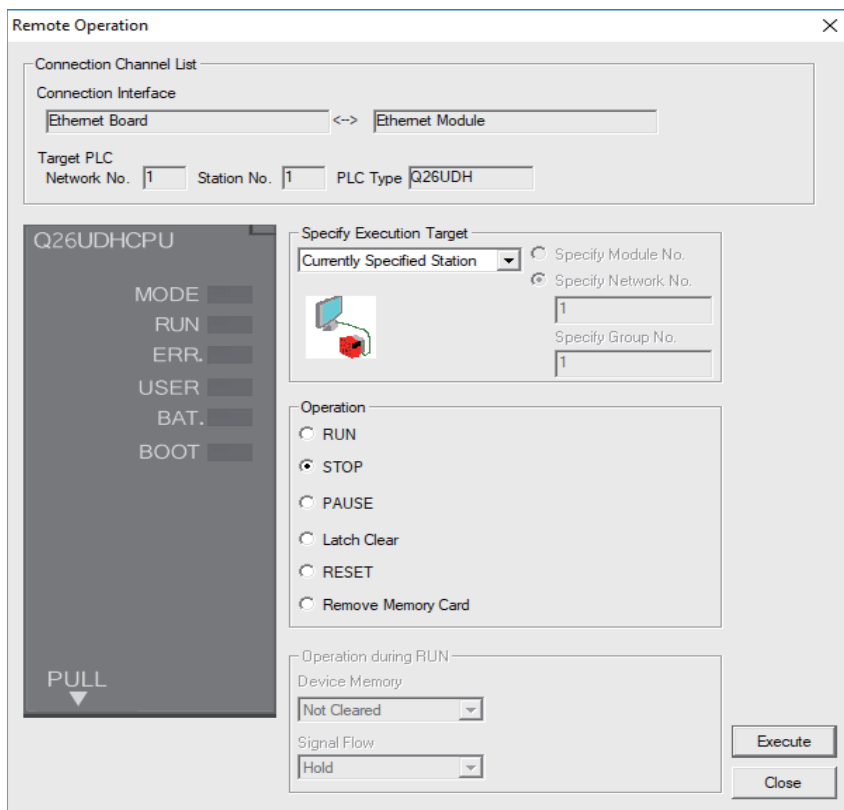

Note

- Only RUN and STOP can be executed.

(3) The operation is completed when the following dialog appears. Click [OK]. The status of the PLC can be checked by the lighting of the "RUN" LED. When the status does not change, check whether an alarm is displayed on the CNC controller.

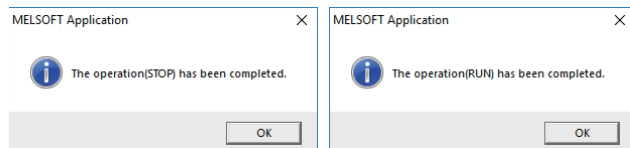

5.5.10 Reading Sequence Programs in GX Developer Format

Sequence programs created by GX Developer can be read on GX Works2.

This allows sequence programs for CNC controllers previously created by GX Developer to be used in development on GX Works2.

Refer to "5.15.3 Multi-Language Data" for precaution of multi-language data setting.

5.5.10.1 Reading Sequence Programs in GX Developer Format on GX Works2

Read sequence programs created by GX Developer on GX Works2 as follows.

(1) Display the file selection screen by the following operation on GX Works2.

[Project] -> [Open Other Data] -> [Open Other Project]

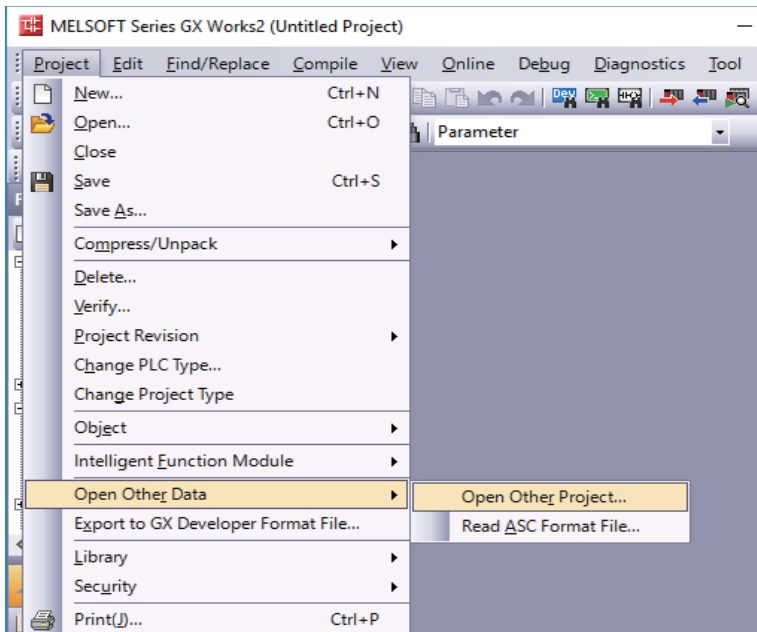

(2) Select the project, and click [Open] on the following screen.

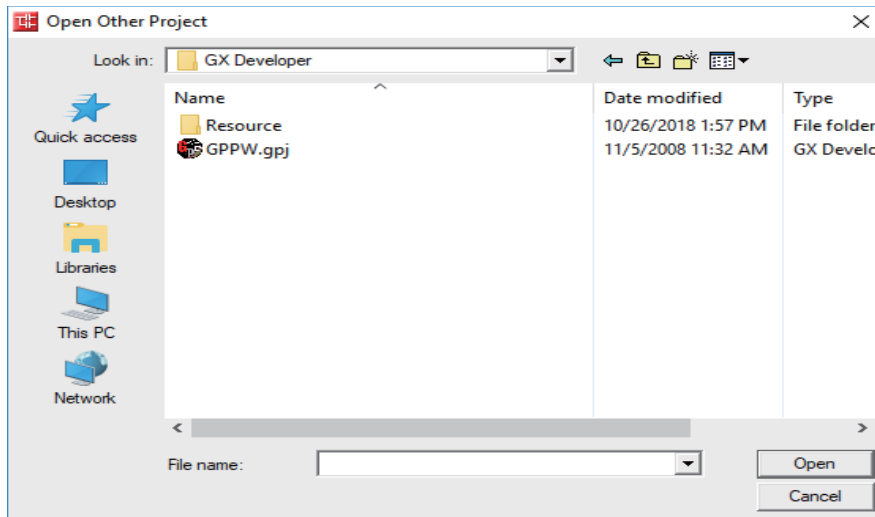

The operation is completed when the following dialog appears. Click [OK].

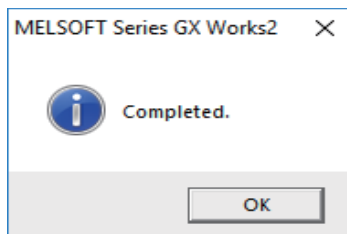

5.5.11 Sampling Trace of Device

The sampling trace function of GX Works2 enables the sampling trace (hereafter trace) of the status of the external signals of the CNC controller and devices used in user ladders. Trace results can be read from the CNC controller after trace to be displayed on the screen and output as a CSV file.

■ Example of trace result display

The present values of devices are displayed for each sampling point. The trend graph of word devices is also displayed. The chart is displayed in the upper part of the screen; the trend graph of word devices is displayed in the lower part of the display. The red mark indicates the trigger position.

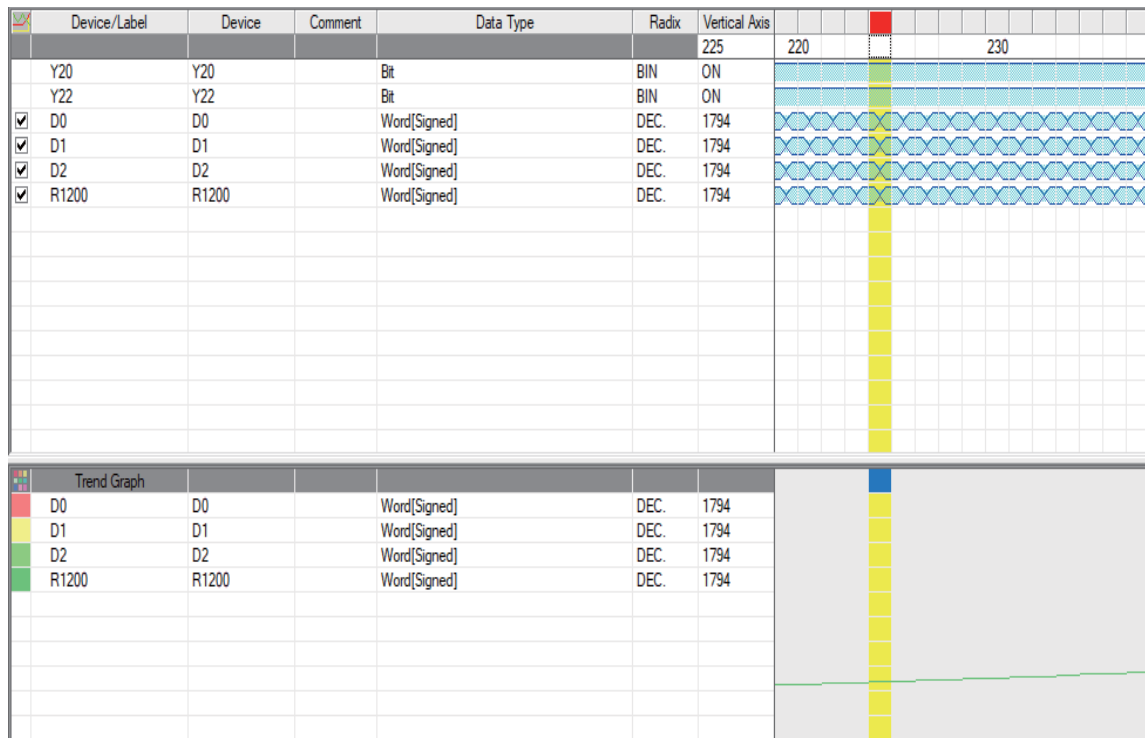

The display items on the Sampling Trace screen are as follows.

Item name	Details
Device/Label	Set devices and labels to be traced. 50 bit devices and 50 word devices can be registered.
Device	Devices corresponding to "Device/Label" are displayed.
Comment	Input device comments corresponding to "Device/Label" are displayed.
Data type	"Data type "of "Device/Label" is displayed.
Radix	Radix of the devices input in "Device/Label" is displayed. For bit devices, it is fixed as "BIN". For word devices, "BIN (Binary)", "DEC. (Decimal)", "HEX. (Hexadecimal)", or "ASCII" can be selected.
Vertical Axis	Data of the time axis of the selected cell is displayed.

Click the [Switch Chart/Detail] button  to display detailed data.

Device/Label	Device	Comment	Data Type	Radix	Vertical Axis	223	224	225	226	227	228	229	230
Y20	Y20		Bit	BIN	ON	*	*	*	*	*	*	*	*
Y22	Y22		Bit	BIN	ON	*	*	*	*	*	*	*	*
<input checked="" type="checkbox"/> D0	D0		Word[Signed]	DEC.	1794	1792	1793	1794	1795	1796	1797	1798	1799
<input checked="" type="checkbox"/> D1	D1		Word[Signed]	DEC.	1794	1792	1793	1794	1795	1796	1797	1798	1799
<input checked="" type="checkbox"/> D2	D2		Word[Signed]	DEC.	1794	1792	1793	1794	1795	1796	1797	1798	1799
<input checked="" type="checkbox"/> R1200	R1200		Word[Signed]	DEC.	1794	1792	1793	1794	1795	1796	1797	1798	1799

Trace count, trace condition, trigger condition, and trace count after trigger can be set in trace setting.

Trace is executed when trace conditions are all met.

After trigger conditions are met, trace is executed for the number of times set in the trace count after trigger, then finishes. The status before and after trigger conditions are met can be sampled.

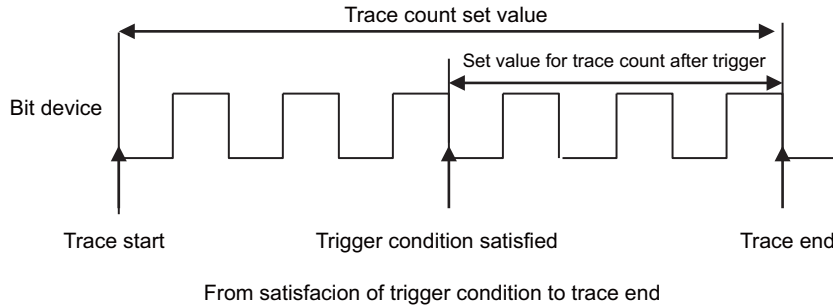

5.5.11.1 Basic Operation

The operation for sampling trace is done on GX Works2. Execute the sampling trace function as follows. For detail on actual operating procedure on GX Works2, refer to "5.5.11.4 Sampling Trace Operating Procedure". Sampling trace of each project in the multi-project mode is possible.

(1) Configure trace setting.

Setting item	Setting
Trace Count Setting	Set trace count to be saved. Data items for trace count from the latest data are saved. When trace count is exceeded, data is deleted from the oldest one.
Count After Trigger	Set the trace count executed from the trigger is established until the sampling completes.
Data Acquisition Timing Setting	This refers to "trace condition". Set the data tracing timing. Either "Each Scan" or "Detail Setting" can be selected. Do not select the other options. In "Detail Setting", conditions for executing trace can be set.
Trigger Condition Setting	Set the timing of trigger. When trigger is established, status of trace device is taken in. "At the Time of Manual Trigger Execution" or "Detail Setting" can be selected. "Detail" enables the trigger establishment condition setting.
Trace device	Set the device to be traced.

(2) Write trace setting to the CNC controller.

(3) Execute trace. The CNC controller starts tracing devices. The execution status during trace is displayed on the trace status in GX Works2, and can be checked by the special relay SM800 to SM805 of the CNC. Trace continues until the following conditions are met.

- (a) Tracing is completed upon establishment of trigger.
- (b) Stop tracing from GX Works2.
- (c) Turn the CNC controller power OFF.
- (d) PLC turns to STOP mode.

(4) Read the trace data from the CNC controller.

(5) Display the result, and, if necessary, output the result to a file.

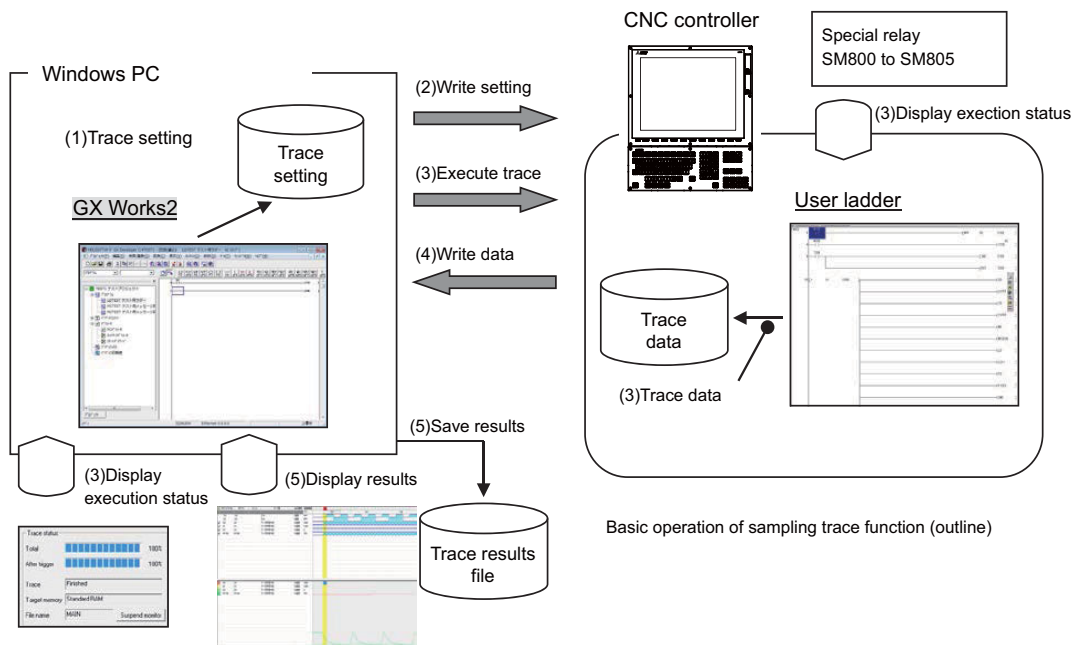

- The trace conditions (setting) set in (1) are retained even after the CNC is powered OFF.
- The trace data obtained in (4) are erased after the CNC is powered OFF.
- The trace conditions are retained in (2). If the CNC power is turned OFF before the settings are written, the conditions changed before settings are written are not retained, and the previous trace conditions are retained.

5.5.11.2 Basic Specifications

[Basic specifications list]

("[" shows the name in built-in edit function)

Details	Specifications		
Multi-project	Sampling trace can be executed for each project. Refer to (*6) for the timing of sampling when the multi-project is enabled.		
Trace count	The number between 1 and 8192 can be set. Note that, however, the total trace data size has to be smaller than 220 kilobytes. (The data size for a project depends on the number of usable projects.) Refer to (*1) for trace data size calculation.		
Trace count after trigger	Sets the number smaller than the No. of traces.		
Data acquisition timing [trace point] (Each scan or specified interval)	Each scan	Trace on scan of main processes.	
	Detail (Other notes are listed outside the table. (*4)Refer to "(*4)" for details.	Word device	Applicable device: Refer to (*2). Setting condition: Set the value to be used for the condition and the judgement. When the setting value becomes equal to the word device value, or when the value of the word device changes judgement will be effective and trigger is executed.
		Bit device	Applicable device: Refer to (*2). Setting condition: Set ↑ or ↓ . When the setting condition is satisfied, trace is executed.
Trigger condition [trigger point] (Two types of setting: "At the time of trigger operation from GX Works2" and "Detail" are available.)	At the time of trigger operation from GX Works2 Executes trigger by GX Works2 operations.		
	Detail (Other notes are listed outside the table. (*5)Refer to "(*5)" for details.	Word device	Applicable device: Refer to (*2). Setting condition: Sets the value to be used for judgement. When the setting value becomes equal to the word device value, judgement will be effective and trigger is executed. Refer to (*5) for when writing to the device.
		Bit device	Applicable device: Refer to (*2). Setting condition: Set ↑ or ↓ . When the setting condition is satisfied, trace is executed.
Trace device	Up to 50 points of word device, 50 points of bit device can be set. Note that, however, the total trace data size has to be smaller than 220 kilobytes. Refer to (*1) for trace data size calculation. (The data size for a project depends on the number of usable projects.) Applicable device: Refer to (*3).		

(*1) Trace data size calculation

The trace data size in one project varies with the number of multi-projects that can be used.

[Trace data size per project for the number of projects that can be used]

The number of projects that can be used	Maximum trace data size per project
6	25 kilobytes
5	32 kilobytes
4	44 kilobytes
3	64 kilobytes
2 projects	103 kilobytes
1	220 kilobytes
User safety sequence	220 kilobytes

For example, if the number of usable projects is 6, set the number of traces and the trace devices so that the trace data size is 25 kilobytes (25600 bytes) or smaller. Trace data size will be calculated as follows.

[Trace data size (byte)] = [Size required for one trace (byte)] x [Number of traces]

Size required for one trace is calculated from the number of word devices, the number of bit devices for trace and the size required for one trace of each device. When time information is added, 4 bytes per trace is required.

[Size required for one trace of each device]

Trace device type	Size (byte) required for one trace
Word device	2 bytes per point
Bit device	2 bytes per unit (1 unit = 16 points) 1 to 16 points -> 1 unit -> 2 bytes 17 to 32 points -> 2 units -> 4 bytes 33 to 48 points -> 3 units -> 6 bytes 49 to 50 points -> 4 units -> 8 bytes

The size of trace data can be calculated from the following equation.

[Trace data size (byte)]

$$= (([\text{number of bit device units}] + [\text{number of word devices}]) \times [2 \text{ (byte)}] + [4 \text{ (byte) (*)}] \times [\text{trace count}])$$

(*) Only when time information is added

Calculation example for trace data size is shown below.

Trace data size calculation examples (when three projects are valid)

No.	Bit device points	Word device points	Trace count	Trace data size	Sampling
1	16 (1 unit)	2	8192	$((1 + 2) \times 2) \times 8192 = 49152 \text{ bytes}$	Possible
2	8 (1 unit)	8	1000	$((1 + 8) \times 2) \times 1000 = 18000 \text{ bytes}$	Possible
3	50 (4 unit)	50	606	$((4 + 50) \times 2) \times 606 = 65448 \text{ bytes}$	Possible
4	50 (4 unit)	50	607	$((4 + 50) \times 2) \times 607 = 65556 \text{ bytes}$	Not possible

(*2) Applicable devices with trace/trigger point details setting

Applicable device
Bit device: X, Y, M, L, F, SB, B, SM, T(contact), ST(contact), C(contact) Word device: T(current value), ST(current value), C(current value), D, R, SW, SD, W,ZR Following qualifications are available for the above devices. • Bit device digit designation • Word device bit designation

When any inapplicable device is set for [Device], an error occurs when the trace setting file to execute trace is read.

(*3) Applicable devices with device setting

Applicable device
Bit device: X, Y, M, L, F, SB, B, SM, T(contact), T(coil), ST(contact), ST(coil), C(contact), C(coil) Word device: T(current value), ST(current value), C(current value), D, R, SW, SD, W,ZR Following qualifications are available for the above devices. • Bit device digit designation • Word device bit designation

Process following an inapplicable device setting is as follows.

- If one or more applicable devices already exist, the setting of the inapplicable device will be ignored.
- If no applicable devices exist, an error occurs at trace execution.

(*4) Precautions for trace point details setting

- When only devices that are not corresponding to Mitsubishi Electric CNC are set for "Device", an error occurs when the trace setting file to execute trace is read.

(*5) Precautions for trigger point details setting

- When devices that are not corresponding to Mitsubishi Electric CNC are set for [Device], an error occurs when the trace setting file to execute trace is read.
- When you select "Word device" in [Device] and "Write data" in [Condition] for the trigger point settings, an error occurs when the trace setting file to execute trace is read.

(*6) Precautions on multi-project function

When the multi-project is enabled, one scan is executed in the order specified by the user.

Sampling is started after one scan is executed. Therefore, there may be some restrictions in operation depending on the settings.

[Example 1: Three projects]

Project execution order		1 -> 2 -> 3
Program (ladder) Device R: project-common Device D: project-specific	Project 1	Device R0 <- 1, Device D0 <- 1
	Project 2	Device R0 <- 2, Device D0 <- 2
	Project 3	Device R0 <- 3, Device D0 <- 3
Trace setting	Project 1 to 3 the same	Trace point: Each scan Trace device: R0, D0
Trace result (1 sampling extracted)	Project 1	R0: 3, D0: 1
	Project 2	R0: 3, D0: 2
	Project 3	R0: 3, D0: 3

In the above example, sampling is executed after the operation of project 3. Therefore, the result of update performed in project 3 is used as the sampling data for R0 (the device common to all projects) of all projects.

[Example 2: Six projects]

Project execution order		6 -> 1 -> 5 -> 2 -> 4 -> 3
Program (ladder) Device R: project-common Device D: project-specific	Project 1	Device R0 <- 1, Device D0 <- 1
	Project 2	Device R0 <- 2, Device D0 <- 2
	Project 3	Device R0 <- 3, Device D0 <- 3
	Project 4	Device R0 <- 4, Device D0 <- 4
	Project 5	Device R0 <- 5, Device D0 <- 5
	Project 6	Device R0 <- 6, Device D0 <- 6
Trace setting	Project 1 to 3 the same	Trace point: Each scan Trace device: R0, D0
	Project 4 to 6 the same	Trace point: Detailed setting When device R0 is 5 Trace device: R0, D0
Trace result (1 sampling extracted)	Project 1	R0: 3, D0: 1
	Project 2	R0: 3, D0: 2
	Project 3	R0: 3, D0: 3
	Project 4	No trace
	Project 5	No trace
	Project 6	No trace

In the above example, sampling is executed after the operation of project 3. Therefore, the result of update performed in project 3 is used as the sampling data for R0 (the device common to all projects) of all projects.

For project 4 to 6 for which the trace point is specified as "when device R0 is 5", tracing is not performed because R0 is "3" at the sampling timing.

5.5.11.3 Status of Special Relay during Sampling Trace

The status during the execution of the sampling trace function can be checked by the status of SM device 800 to 805.

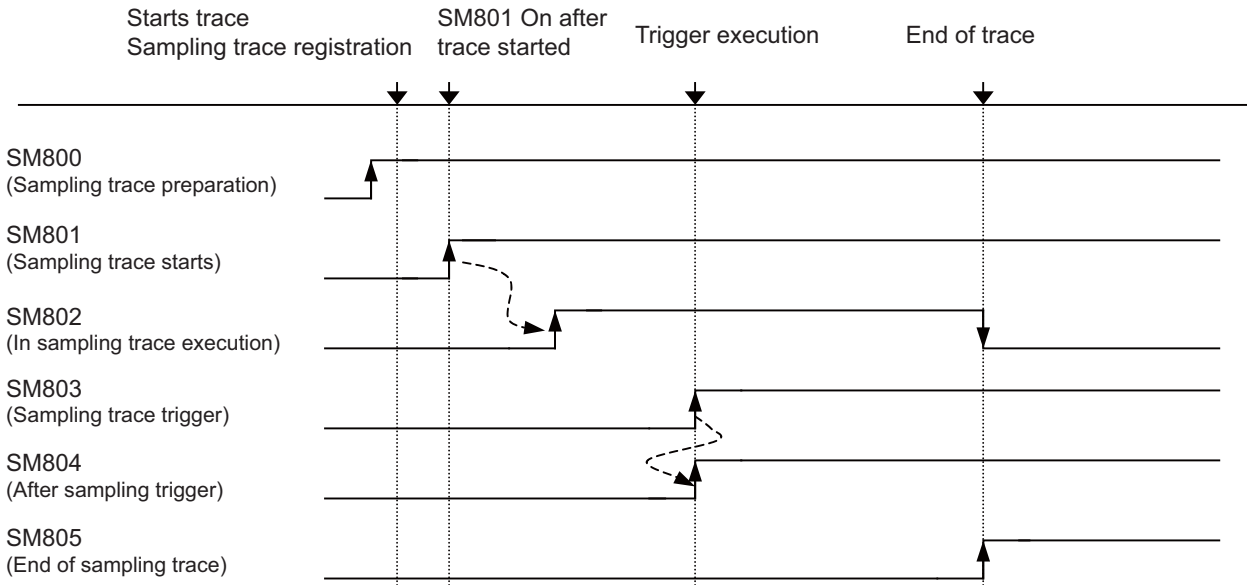

*SM800 automatically turns ON when sampling trace preparation is done.

Device status when trace execution operation is carried out.

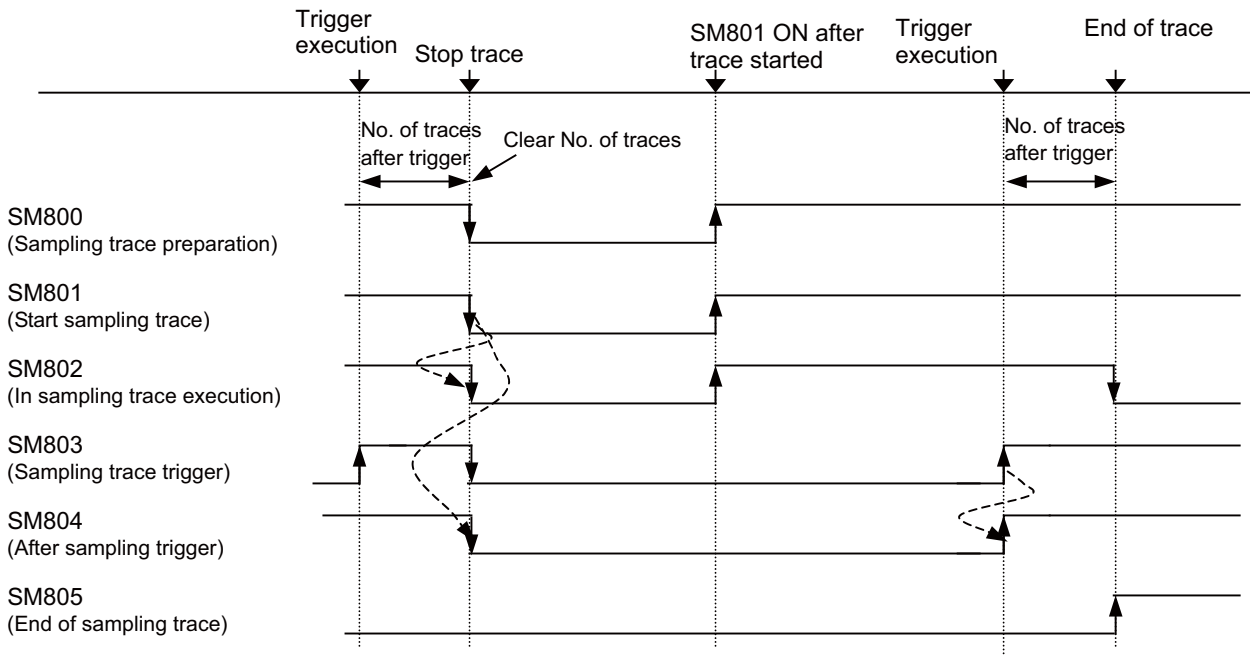

Device status when trace stop operation is carried out

The specifications of SM800 to SM805 are as follows.

[List of sampling trace function related device specifications]

No.	Items	Details
SM800	Sampling trace preparation	OFF: Preparation not completed ON: Preparation completed
SM801	Starts sampling trace	OFF: Cancel ON : Start
SM802	In sampling trace execution	OFF: Cancel ON : Start
SM803	Sampling trace trigger	OFF -> ON:Trigger execution
SM804	After sampling trace trigger	OFF: Not after trigger ON : After trigger
SM805	End of sampling trace	OFF: Not completed ON: Completed

5.5.11.4 Sampling Trace Operating Procedure

This section provides the overview of trace operating procedure and cautions. For details of basic operating procedure, refer to "GX Works2 Operating Manual (Common)".

Sampling trace screen

Select [Debug] - [Sampling Trace] - [Open Sampling Trace] to open the "Sampling Trace" screen.

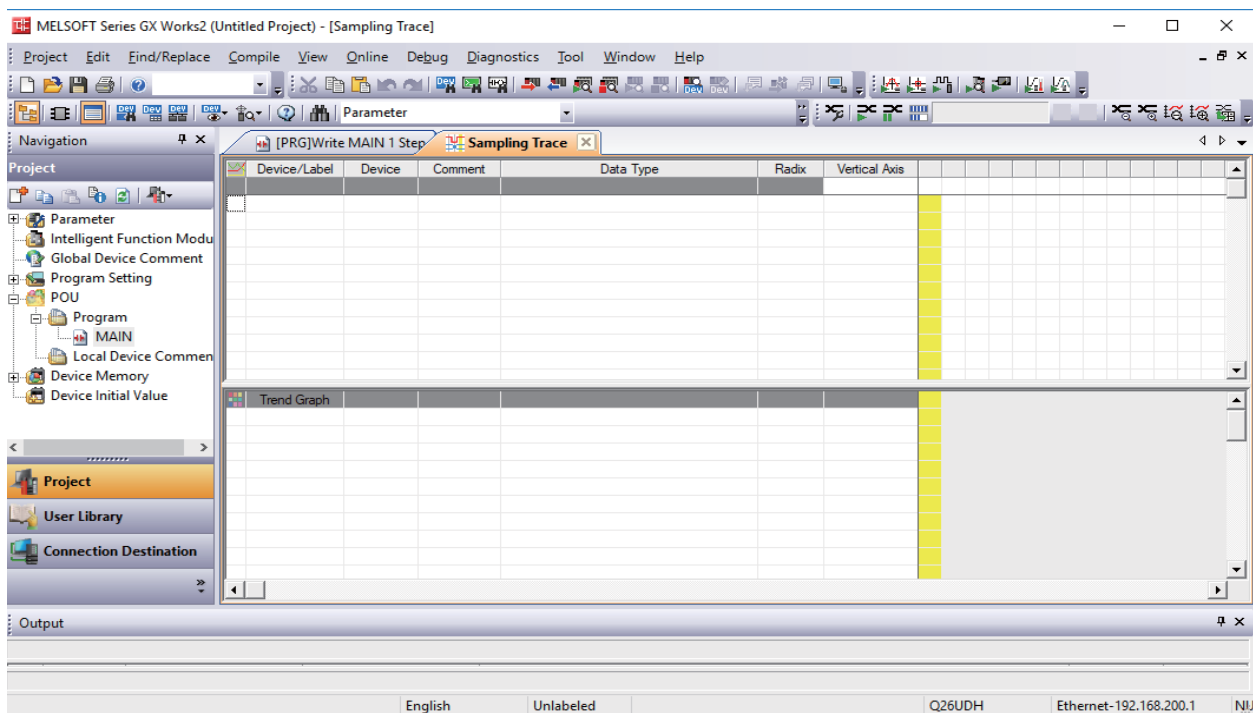

Setting execute conditions for sampling trace

(1) Open [Debug] - [Sampling Trace] - [Trace Setting], and configure the settings on the [Setting of Executing and Saving] tab.

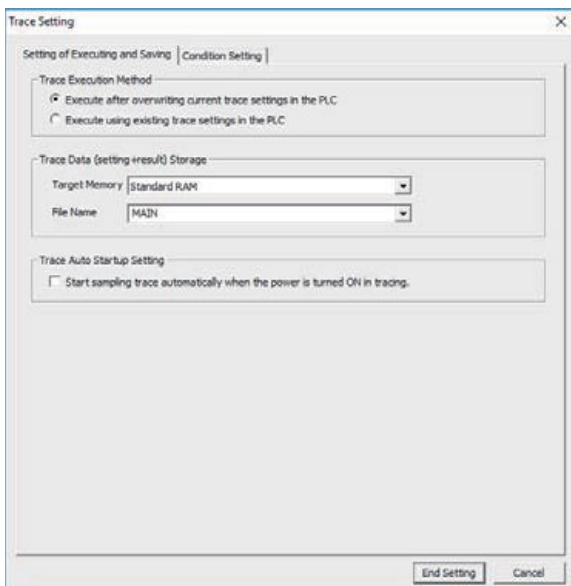

Item	Setting
Trace Execution Method	Execute after overwriting current trace settings in the PLC
Trace Data (setting + result) Storage	
Target Memory	Standard RAM (*1)
File Name	Any file name
Trace Auto Startup Setting	Not check

(*1) Since [Target Memory] is the RAM CNC controller, trace data (result) are erased at power OFF.

Only one trace data set (setting, result) can be saved on the CNC controller. Trace data result is overwritten every time sample trace is executed.

(2) Configure settings on the [Condition Setting] tab as follows.

(*) No setting is required if [Execute using existing trace settings in the PLC] is selected as the trace execution method.

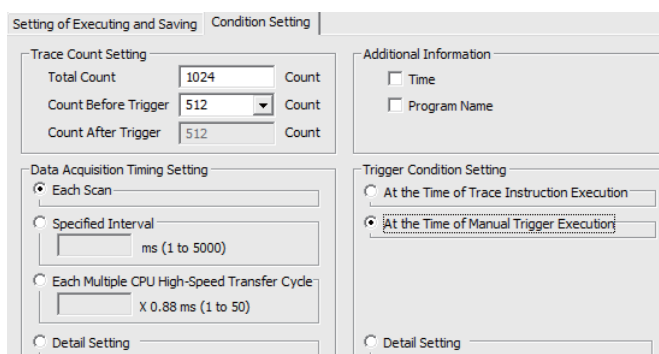

Item	Setting
Trace Count Setting	
Total Count	1 to 8192
Count Before Trigger	0 to Total Count -1
Additional Information	
Time	Optional (*1)
Program Name	Not check
Data Acquisition Timing Setting	Each scan or Detail Setting (*2)
Trigger Condition Setting	At the Time of Manual Trigger Execution or Detail Setting (*2)

(*1) If time information is added, the size of traceable data becomes smaller than usual by [4 bytes] × [Trace Count].

(*2) When selecting Detail Setting, click [Setting Change...] and configure settings as follows.

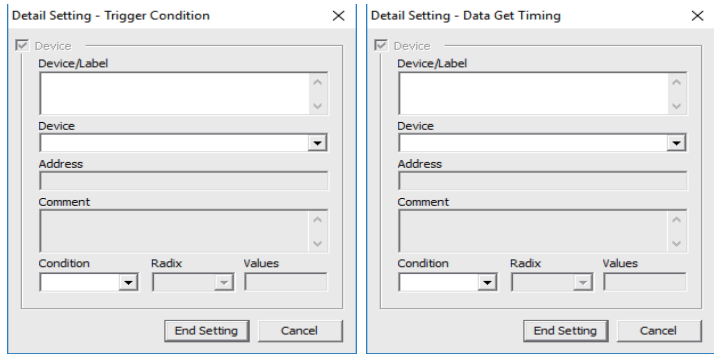

Item	Setting
Device/Label	Device or label to be used in condition (*1)
Device	Display the device corresponds to "Device/Label".
Comment	Display the device comment of "Device /Label".
Condition	
Bit device	at the rising (↑), or at the falling (↓)
Word device	=, or Change
Radix (Word device only)	Decimal or hexadecimal
Values (Word device and "=" only)	Optional

(*1) Refer to "5.5.11.2 Basic Specifications" for the devices that can be set.

Executing trace

This section describes how to start and stop trace, and execute trigger.

(1) Start trace

Click [Debug] - [Sampling Trace] - [Start Trace]. Trace is started.

The progress status of trace can be checked by [Trace Data Storage Status].

Click [Close] to close the [Display Trace Buffer Condition] window.

To display the trace execution screen again after clicking [Close], click [Debug] - [Sampling Trace] - [Display Trace Buffer Condition].

Note

- Trace cannot be executed again until the execution of trace ends.
- If [Execute using existing trace settings in the PLC] is selected as the trace execution method, and trace settings are not written to the CNC, an error occurs when [Debug] - [Sampling Trace] - [Start Trace] is clicked. Start trace after writing trace settings to the CNC.
- When trace is started, previous trace data are deleted.

(2) Execute trigger

When [At the Time of Execute Manual Trigger] is set in [Trigger Condition Setting], trigger can be executed at any timing.

Click [Debug] - [Sampling Trace] - [Execute Manual Trigger].

(3) Stop trace

To stop trace, click [Debug] - [Sampling Trace] - [Stop Trace]. The results up to the trace stop is displayed on the "Sampling Trace" screen.

Note

- Stopped trace cannot be restarted.
- If trace is started before data are saved, data before trace stop are deleted. Save trace data before stop as a CSV file by selecting [Debug] - [Sampling Trace] - [Export CSV Data] as needed.

(4) End of trace

Trace is executed for the preset times of trace after the execution of trigger, the "Trace Data Storage Status" screen is closed, and trace is completed. After that, trace results are automatically read to GX Works2 and displayed as follows.

Click the [Switch Chart/Detail] button  to display detailed data.

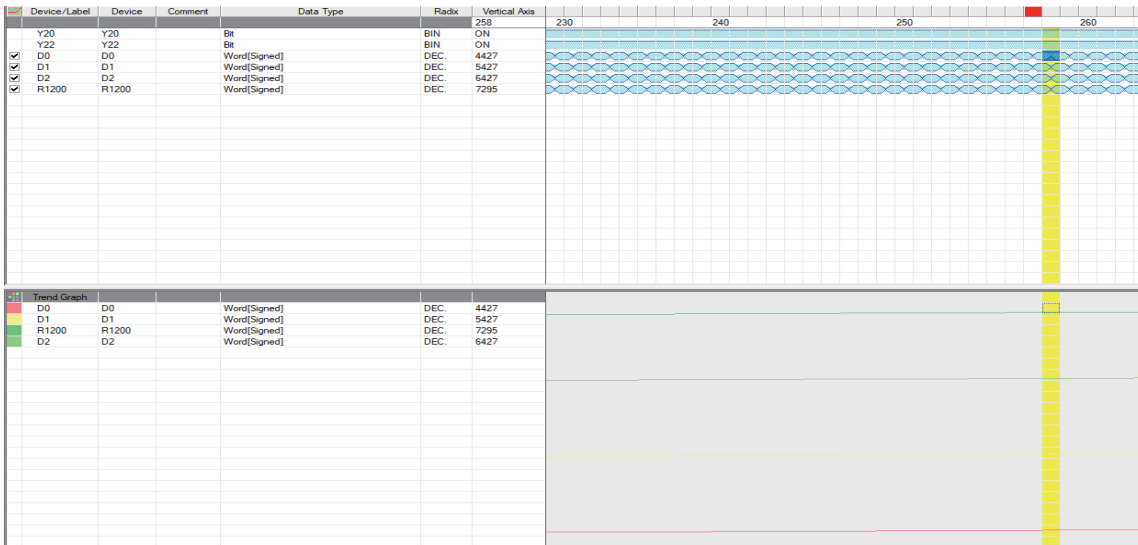

For details on how to evaluate trace result, refer to "19.4 Sampling Trace in GX Works2 Operating Manual (Common)".

(5) End trace screen

Even when the "Sampling Trace" screen is closed, or GX Works2 is ended while trace is being executed, trace is executed. Restart GX Works2, open the "Sampling Trace" screen, click [Read from PLC] to read the result of trace executed.

Displaying trace results

When the "Sampling Trace" screen is closed, or GX Works2 is ended while trace is being executed, manually read trace results from the CNC controller.

- (1) Start GX Works2, click [Debug] - [Sampling Trace] - [Open Sampling Trace] to open the "Sampling Trace" screen.
- (2) Click [Debug] - [Sampling Trace] - [Read from PLC].

Saving trace result

- (1) Click [Debug] - [Sampling Trace] - [Export CSV Data] to open the "Export CSV Data" window.

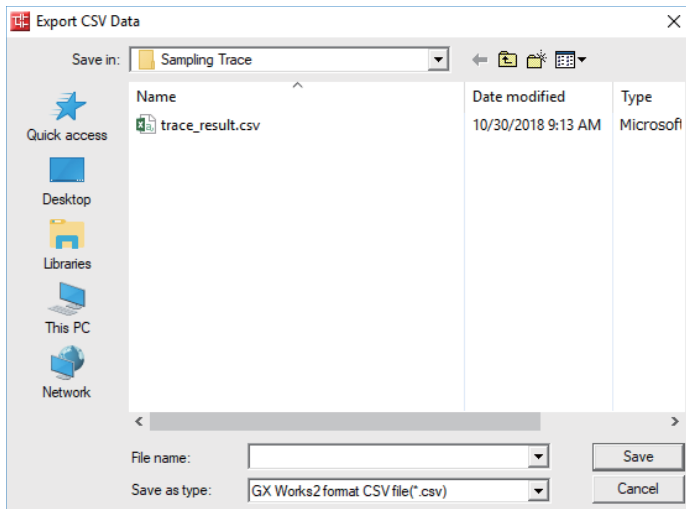

- (2) Select the location for storage, input a file name, and click [Save].

Note

- (1) Trace result data are overwritten every time trace is executed. Save data as a CSV file as necessary.

Retaining trace execution status

The trace execution status is retained after the CNC is turned OFF.
This allows trace to be executed from power ON as follows.

- (1) Turn OFF the CNC while trace is being executed.
To check the progress of trace, click [Debug] - [Sampling Trace] - [Display Trace Buffer Condition] to display the "Trace Data Storage Status" screen.

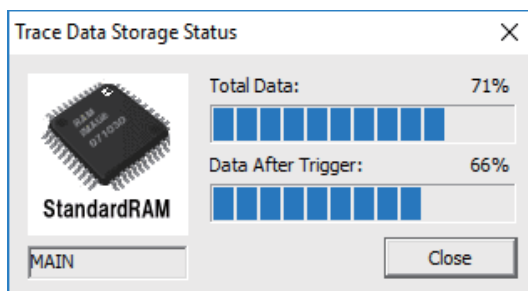

- (2) Turn the CNC power ON again.
- (3) Trace is executed at the power ON.

Note

- (1) Trace result is erased when the CNC power is turned OFF.
- (2) Even when the post-trigger status is active at the CNC power OFF, the tracing at the power ON is always started from the pre-trigger status.

5.5.11.5 Operation on Error

An error is generated under the following condition, and an error dialog is displayed on the GX Works2 screen when parameters are checked on trace execution.

No.	Error details	Remedies
(1)	Device setting has no devices that are traceable	Set a traceable device for "Sampling Trace" screen.
(2)	Trace setting has invalid conditions.	Set valid conditions for trace set.
(3)	Detailed trace setting has no valid devices set.	Set a valid device in detailed trace setting.
(4)	The capacity of trace data exceeds the capacity per project	Set the capacity of trace data that does not exceed the capacity per project.

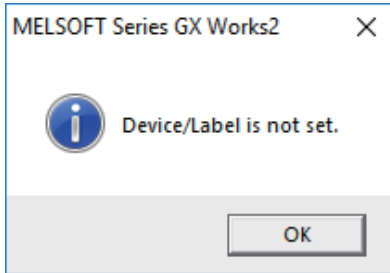

When trace cannot be executed, check the following.

- ♦ Ensure that the CPU type is "Q26UCPU"
- ♦ Check the trace execution status (Trace execution cannot be commanded during trace.)
- ♦ When "Execute using existing trace settings in the PLC" is selected in the trace execution setting, check whether the setting file is saved in the CNC
- ♦ Check the consistency between the devices on the program and devices in the trace setting

5.5.11.6 Operation Example

Example 1: Trigger judgment and trace result with device setting

[Setting details]

Trace settings for example 1

Setting item	Setting value	Setting item	Setting value
Target Memory	Standard RAM	Trigger Condition Setting	♦ Detail Word device Word device 1 = 11
File Name	MAIN		
Total Count	10		
Count After Trigger	4	Device setting	♦ Bit device Device No.1 Device No.2 ♦ Word device Word device 1
Additional Information	Time		
Data Acquisition Timing Setting	Interval: 10 ms		

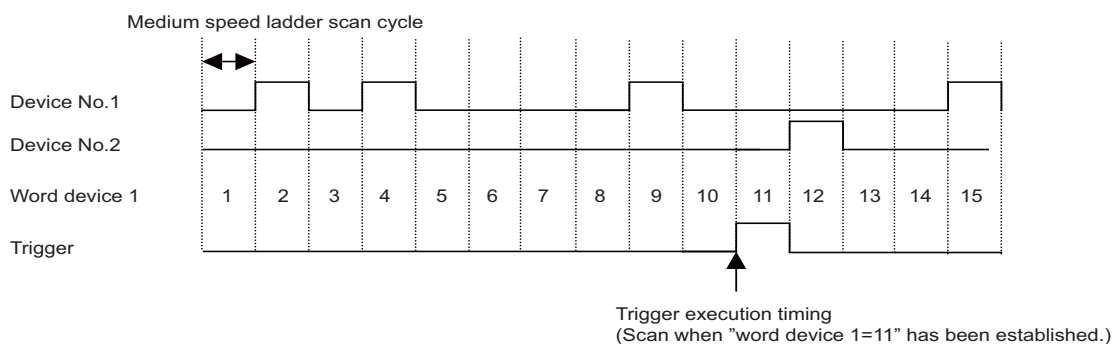

Device status when sampling trace is executed at example 1

[Trace result]

Trace result display for example 1

Count	5	6	7	8	9	10	11	12	13	14	<- The scan at trace start is count 1. Because trace data are imported when trigger condition is satisfied, when the satisfaction of trigger condition and trace overlap, data for count 11 and count 12 are the same. <- Setting for trace point by the hour is ignored, and trace is executed at each scan. <- Word device is displayed as numeric values on the detailed data screen. <- Trace Additional Information is displayed as time on the detailed data screen.
Device No.1					█						
Device No.2									█		
Word device 1	5	6	7	8	9	10	11	11	12	13	
Time	0	0.007	0.014	0.021	0.028	0.035	0.042	0.042	0.049	0.056	

Example 2: Trace judgment and trace result with device setting

[Setting details]

Trace setting details for example 2

Setting item	Setting value	Setting item	Setting value
Target Memory	Standard RAM	Trigger Condition Setting	• At the time of TRACE instruction execution
File Name	MAIN		
Total Count	6		
Count After Trigger	4	Device setting	• Bit device Device No.1 Device No.2 • Word device Word device 1
Additional Information	None		
Data Acquisition Timing Setting	• Device Bit device Device No.1 ↑		

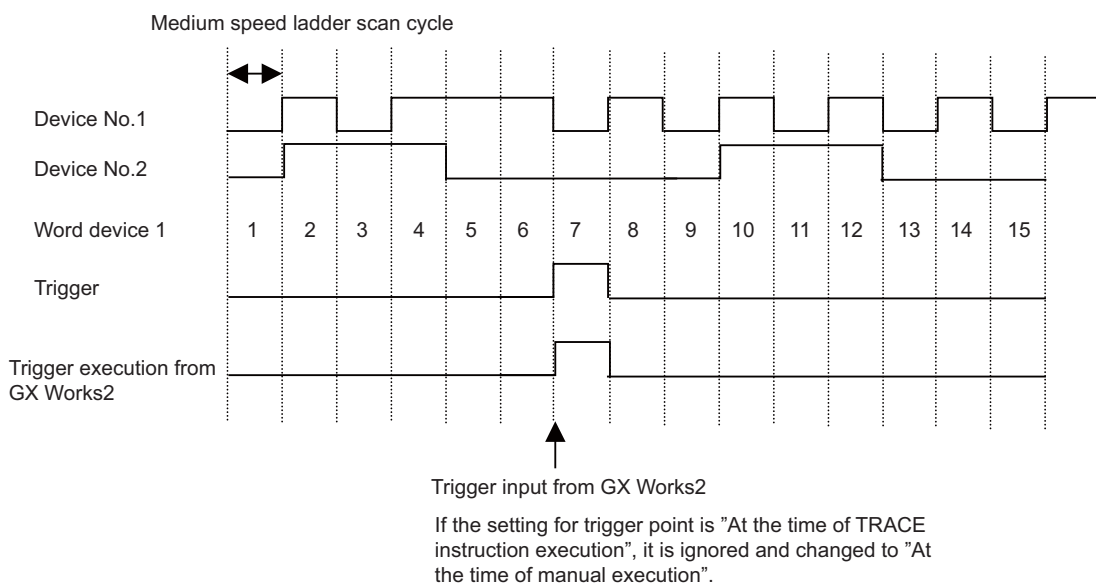

Device status when sampling trace is executed at example 2

[Trace result]

Trace result display for example 2

Count	1	2	3	4	5	6
Device No.1	ON	OFF	OFF	ON	ON	ON
Device No.2	ON	ON	OFF	OFF	ON	ON
Word device 1	2	4	7	8	10	12

<- Trace scan at trace start is count 1.

<- Trace is executed only for the scan where device No.1 turns ON from OFF.

Device data for the scan when trigger is executed is saved

5.5.11.7 Precautions

- (1) Trace can be executed for the other stations on the network or with serial communication connection. However, it is not possible to execute trace from multiple areas at the same time .
- (2) The trace conditions registered in the CNC are retained after the CNC power is turned OFF.
 Trace data are deleted when the CNC power is turned OFF.
 However, the saved data is discarded when any of the following states occurs.
 - ◆ Data are inconsistent with the saved trace conditions (the trace size and the device range) at the power ON.
 - ◆ Data are inconsistent with the saved trace conditions (the trace size and the device range) when the multi-project setting is changed from the on-board and the CNC is restarted.
 - ◆ Data are inconsistent with the saved trace conditions (the trace size and the device range) when USERPLC.LAD which has different multi-project setting is input through [Mainte] [I/O] on the NC screen and the CNC is restarted.
- (3) Sampling trace is executed by connecting CNC controller and GX Works2.
- (4) Previous trace data in the CNC are deleted during the execution of trace. Save them before executing trace if necessary.
- (5) When trace is ended before reaching the set No. of traces, such as when trigger occurs as soon as trace is started, the shortened data will not be displayed.

(Example) Trigger condition is met at 10th trace when the number of traces is set to "2000" and the number of traces after trigger is set to "1000".

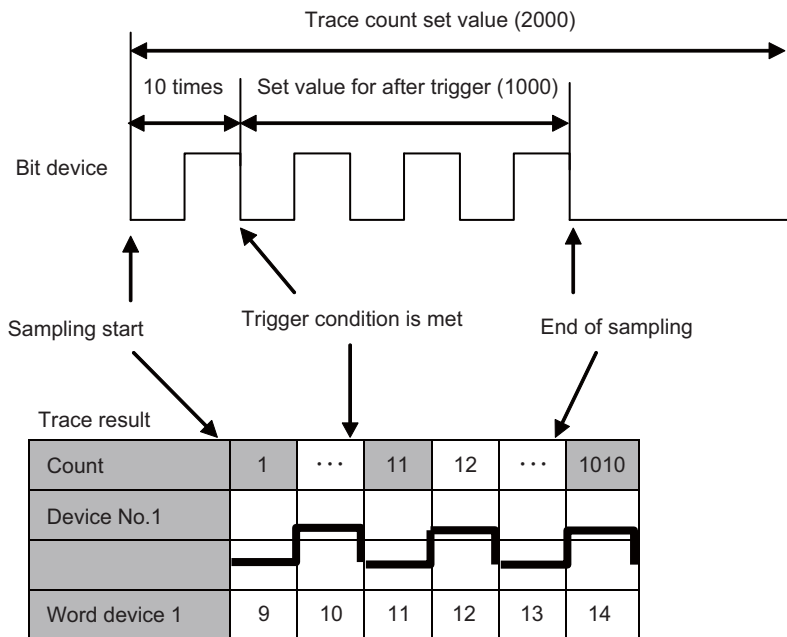

(6) When [Specified Interval] or [Each Multiple CPU High-Speed Transfer Cycle] is set as [Data Acquisition Timing Setting] in trace setting, they are rewritten as [Each Scan] at trace start. When [At the Time of Trace Instruction Execution] is set as Trigger condition, it is rewritten as [At the Time of Manual Trigger Execution] at trace start. When the Program Name under Additional Information is checked, it is removed at trace start. For details on what trace settings can be used, refer to "5.5.11.4 Sampling Trace Operating Procedure".

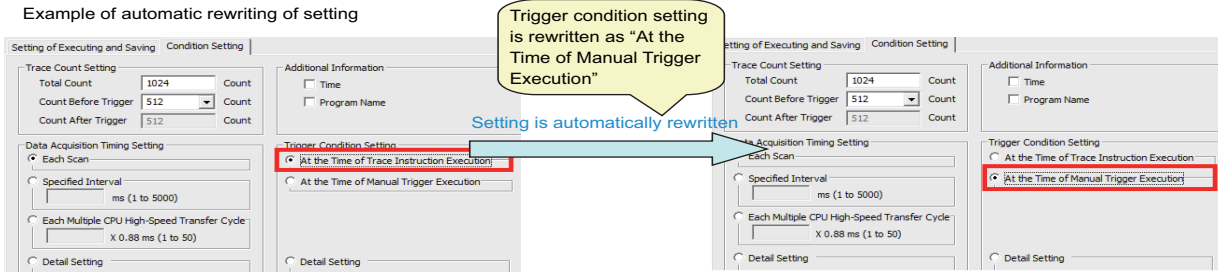

If settings are automatic rewritten in Simple project (with labels), the labels of trace target are overwritten with actual device at trace completion.

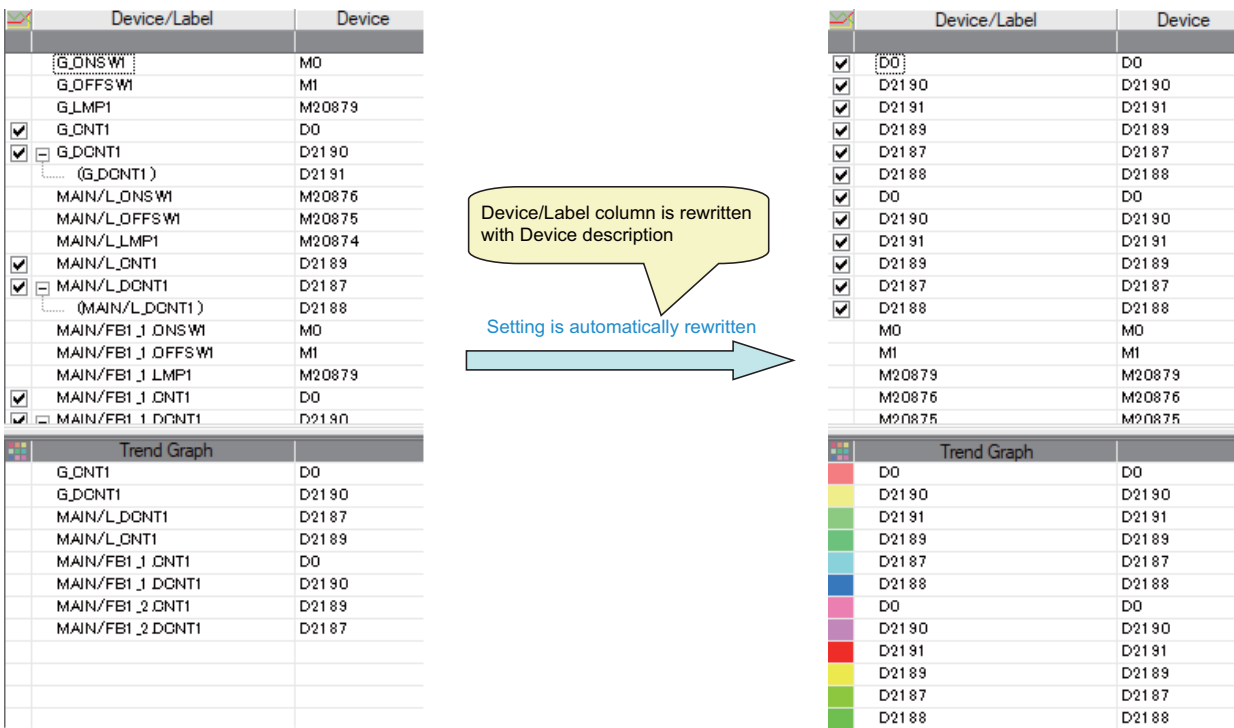

(7) The status of SM800 to SM805 cannot be checked on the CNC controller screen. Check the trace status on GX Works2.

(8) If the CNC power is turned OFF while trace is being executed, the trace is started after the power is turned ON again. (Even if the trace status at power OFF is trace after trigger, the trace after the CNC is powered ON again starts from before trigger.)

To cancel trace started by powering ON the CNC again perform stop operation on the trace execution screen. To prevent trace from being started by powering ON the CNC again, power the CNC OFF while trace is stopped or after performing stop operation on the trace execution screen.

(9) Trace results cannot be read or displayed while trace is being executed.

(10)[Write to PLC] writes only trace settings to the CNC controller; trace results are not written.

(11)When trace data that were executed with labels set as trace target in a simple project (with labels) are read by [Read from PLC], the labels of the trace target are overwritten by actual devices.

(12)[Trace repeat] cannot be set on GX Works2. When executing [Trace repeat] use built-in editing function.

5.5.12 Checking Data Size

Data such as sequence program and comment files can be checked whether its amount is within the allowable range to be written to the CNC by using memory capacity calculation function of GX Works2.

5.5.12.1 Operating Procedures

(1) Start the operation screen by the following operation on GX Works2.

[Tool] -> [Confirm Memory Size]

Select the data you want to write on the following screen and click [Execute].

To select program or parameter, select "Program Memory/Device Memory" for [Target Memory].

To select comment file or source information, select "Memory card (SRAM)" for [Target Memory].

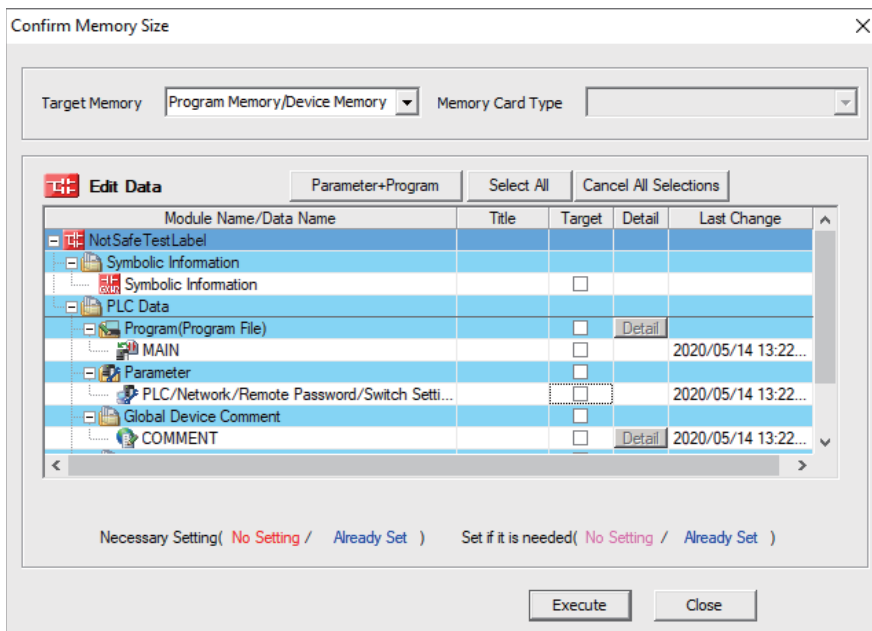

(2) The screen with the [Offline] tab selected appears.

The free capacity displayed on this screen differs from the actual one of the CNC controller.

Select the [Online] tab.

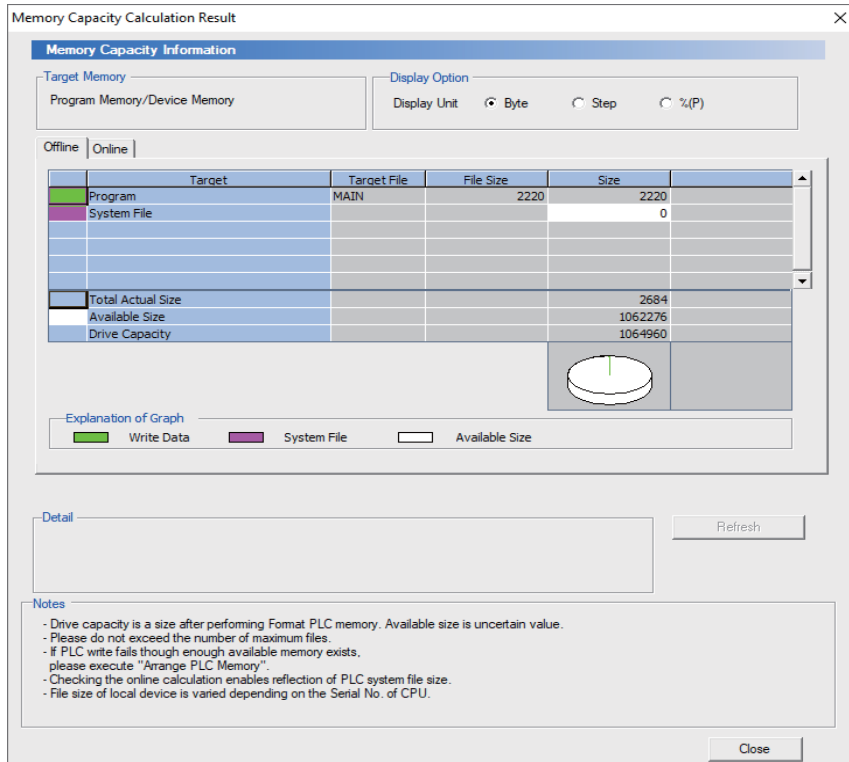

Note

When "Memory card (SRAM)" is selected for [Target Memory], the following screen appears.

Click [OK].

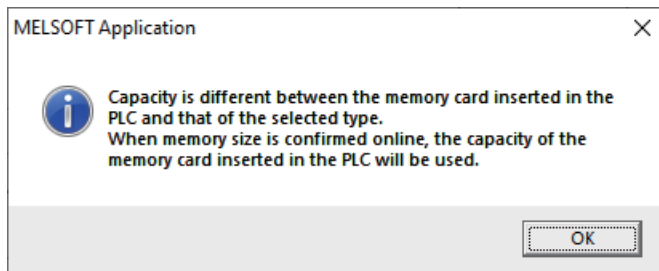

(3) The following screen is displayed.

The free capacity displayed on this screen is equivalent to the actual capacity of the CNC controller.

When there is not enough free capacity, secure the required capacity before writing data.

Memory Capacity Calculation Result

Memory Capacity Information

Target Memory: Program Memory/Device Memory

Display Option: Display Unit Byte Step %(P)

Offline | Online

Target	Target File	File Size	Size
Use Volume			3259772
Program	MAIN	2152	12394
System File		0	12244
Total Actual Size			3284410
Available Size			0
Drive Capacity			3284410

Explanation of Graph: Write Data (Green), System File (Purple), Available Size (White), Use Volume (Blue)

Detail: Refresh

Notes:

- Available size shows the size after writing selected file(s).
- Please do not exceed the number of maximum files.
- If PLC write fails though enough available memory exists, please execute "Arrange PLC Memory".

Close

5.5.12.2 Precautions

- (1) When the source information is selected, the program is also selected automatically. Actual free capacity is the sum of displayed free capacity selected in the [Online] tab and the file size of the program.
- (2) When an item such as comment files and source information of the user safety sequence is selected, the file size on GX Works2 and that on CNC is calculated in double. Therefore, free capacity displayed in the [Online] tab is smaller than the actual size.

To confirm whether the CNC has enough free capacity to write the comment file and source information of the user safety sequence, compare the total file size displayed in the [Offline] tab and the storable data size of the comment for the user safety sequence.

For the user safety sequence, refer to "M800/M80 Series Smart safety observation Specification manual".

5.6 Developing Simple Project

This chapter provides the overview of simple projects and the development procedure focusing on those specific to Mitsubishi Electric CNC.

For the user safety sequence, refer to "M800/M80 Series Smart safety observation Specification manual".

For details of the program types that can be used in simple project, refer to "5.2.1 Support Status of Project Types, Program Types and POU's".

There are two types of simple projects: without labels and with labels. The features of the types are described below.

[Simple project (without labels)]

Simple project (without labels) allows sequence programs to be developed in like conventional GX Developer and built-in edit function. Labels and FB are unavailable.

[Simple project (with labels)]

Simple project (with labels) enables users to create highly versatile sequence program labels without being aware of devices. In simple projects (with labels), FB can be used. In an ST language program, FB can be nested within FB up to one layer. In a ladder diagram program, FB can be nested within FB up to four layers. Programs cannot be input/output in the CSV file format. For details on labels, refer to "5.10 Creating Label"; for details on FB, refer to "5.11 Creating Function Block".

Reserved characters cannot be used in the file names of simple projects (with labels). Use care when changing projects from without labels to with labels. For detail on reserved characters, refer to "GX Works2 Operating Manual (Common)".

To create a sequence program using ST language, select simple project (with labels).

5.6.1 Overview of Simple Project

The configuration of a simple project is as follows. Global label and local label are available only when simple project (with labels) is selected when the project is created.

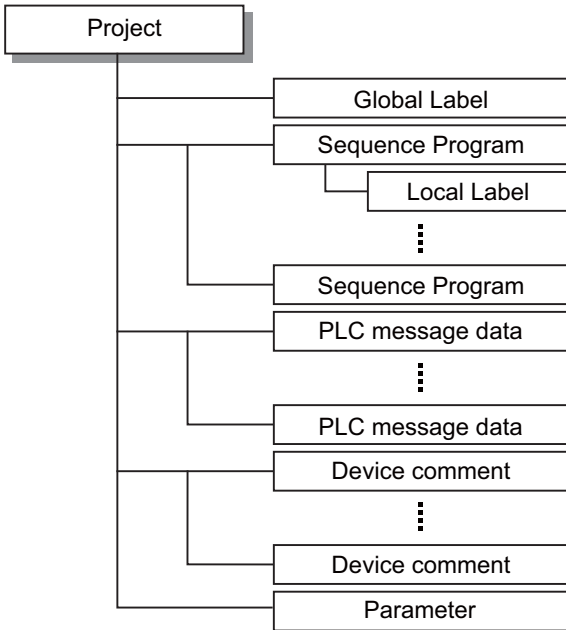

Item	Description
Sequence programs	Sequence program (user PLC) for Mitsubishi Electric CNC
PLC message data	Defines PLC messages such as alarm messages and PLC switches. PLC messages can be used only in ladder diagram. PLC messages cannot be used only in ST language. To use a PLC message in the sequence program created in ST language, it must be written by using some text editor. Otherwise, use a PLC message created in ladder diagram.
Device comments	Comment for devices in sequence programs. There are two types: project-common "Global Device Comment" and program-specific "Local device comment". To change the settings, open [Tools] - [Options] window and select [Program Editor] - [All Editors] - [Device Comments].
Parameter	Set the use range of devices and order of sequence program execution, etc.
Global label (with labels only)	Label variable that becomes valid for all sequence programs when multiple sequence programs are create in a project.
Local label (with labels only)	Label variable that becomes valid only in each sequence program. This is one-on-one setting with an individual sequence program.

5.6.1.1 Symbolic Information

Symbolic information is data storing program configuration such as labels and FB. To read or write labels and FB to the CNC controller, read or write symbolic information.

For details on symbolic information, refer to "GX Works2 Operating Manual (Simple Project)".

5.6.2 Development Procedure

One of the standard procedures for developing simple projects is to create on GX Works2.

5.6.2.1 Developing New Simple Projects on GX Works2

Development Procedure		Reference
(1)	Start GX Works2	-
(2)	Create a new project • Select a project with labels when labels and FBs are used.	5.5.5 Creating Project
(3)	Set connection with CNC controller	5.4.2.5 Setting Connection Destination
(4)	Set parameters • Program setting of PLC parameters, the number of device points in CNC, and the number of device points in GX Works2 must be consistent.	5.5.8 Setting the Parameters
(5)	Edit sequence programs	Ladder Diagram "GX Works2 Operating Manual (Simple Project)" ST Language "GX Works2 Operating Manual (Structured Project)"
(6)	Write sequence programs and parameters into CNC RAM • Sequence programs are written into temporary memory (CNC RAM).	5.5.8.6 Writing and Reading Parameters to CNC Controller 5.6.4 Writing the Sequence Program to the CNC Controller
(7)	Monitor (debug) sequence programs • Return to (5) if any bug is found.	"GX Works2 Operating Manual (Simple Project)"
(8)	After debug is completed, write sequence programs to ROM in CNC. • Sequence programs in temporary memory (CNC RAM) is transferred to CNC ROM.	5.6.6 Writing Sequence Programs to ROM in CNC

Note

- (1) After a project is created, a simple project (without labels) can be changed to a simple project (with labels) by [Project] - [Change Project Type]. Note that these changes cannot be reverted.
- (2) If character string that cannot be used, "Label/data name contains invalid character string. Unable to use devices." is displayed when simple project (with labels) is compiled, reserved characters are used in the file name. Change the file name.
- (3) The timer limit setting must be fixed to "100ms" for low speed or "10.00ms" for high speed. It can be set on [PLC System] tab on the [Q Parameter Setting] setting screen displayed by selecting [Parameter] - [PC Parameter] of the project view. The CNC is not compatible with any other value described above for the timer limit.

5.6.3 Developing Sequence Programs

This section describes how to develop sequence programs in a simple project. There is no basic development procedure that is specific to Mitsubishi Electric CNCs. Refer to "GX Works2 Operating Manual (Simple Project)". This section provides information on CNC-specific restrictions.

5.6.3.1 CNC-Specific Restrictions

■ Restriction on use of ANB instruction and ORB instruction

Condition: Only up to seven ANB instructions and ORB instructions can be used consecutively.

Workaround: When using a ladder containing eight or more of these instructions, use a substitute ladder as follows.

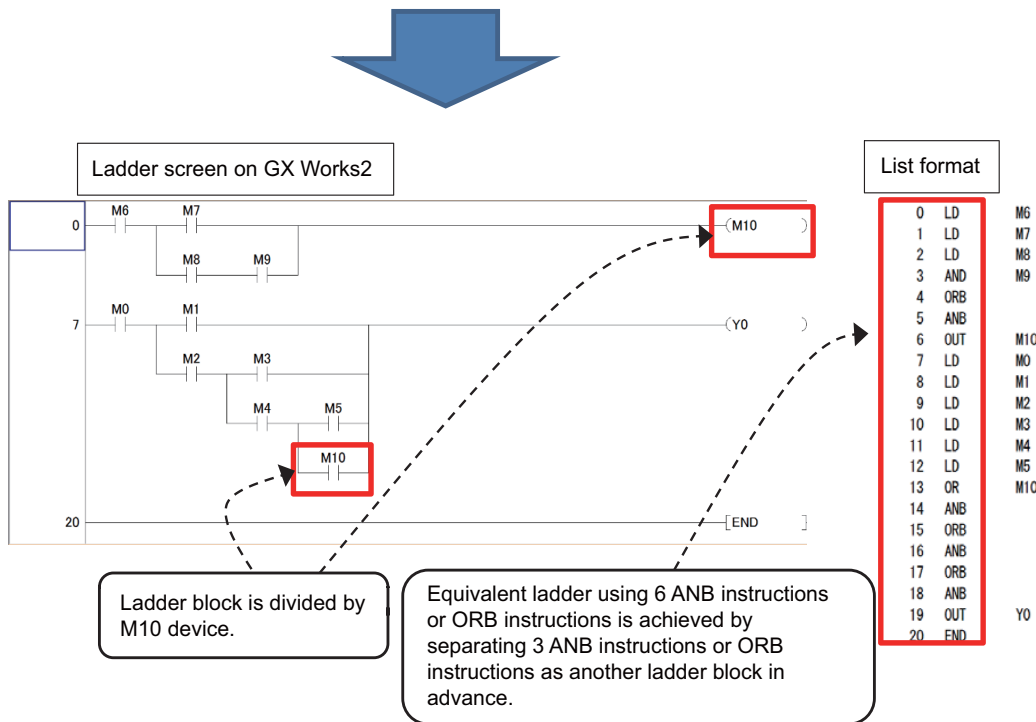
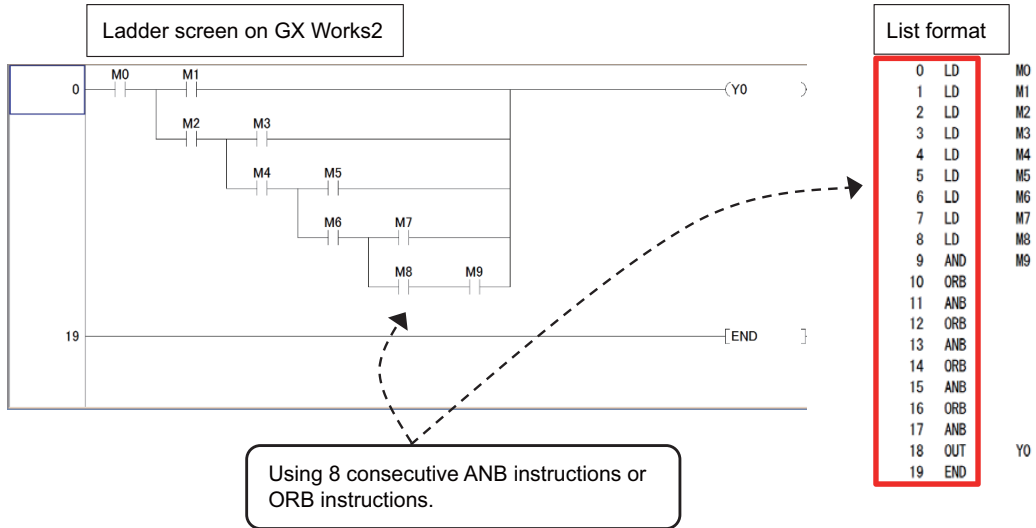

■ **Restriction on MPS instruction use**

Condition: Only up to seven MPS instructions can be used consecutively. When MPP instruction is used, one more MPS instruction becomes available.

Workaround: When using a ladder containing the number of MPS instructions that exceeds the upper limit, use a substitute ladder as follows.

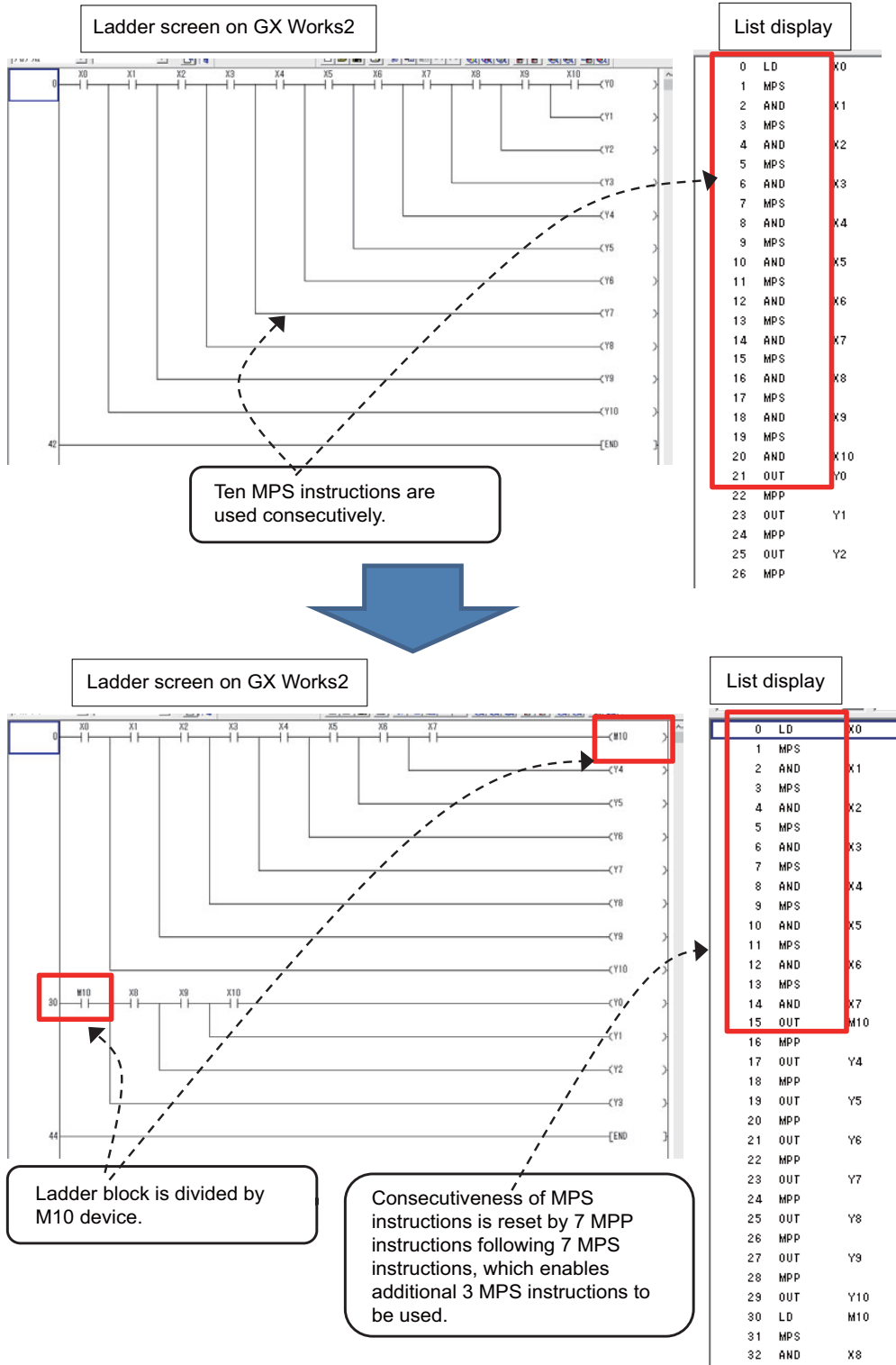

Set the NC parameter "#6456/bit0" to "1" to display an error dialog on GX Works2 when sequence programs, which do not conform to restrictions described in "Restriction on use of ANB instruction and ORB instruction" and "Restriction on MPS instruction use", are written. This prevents PLC from becoming RUN status. When an error dialog is displayed, use the above substitute ladder.

5.6.4 Writing the Sequence Program to the CNC Controller

This section describes how to write sequence programs in a simple projects from GX Works2 to the CNC controller (particularly restrictions and operation specific to this CNC).

Note

- (1) This operation writes data to the temporary storage in the CNC (RAM in CNC). Data in temporary storage (RAM in CNC) are not retained after power OFF. To retain data after power OFF, write sequence programs to the ROM in the CNC according to "5.6.6 Writing Sequence Programs to ROM in CNC".

5.6.4.1 Operation Procedure

■ Operating procedure for simple projects (without labels)

The operating procedure for when labels are not used is described below.

- (1) Start the operation screen by the following operation on GX Works2.
[Online] -> [Write to PLC]
- (2) Select [Program Memory/Device Memory] in [Target Memory Setting] of PLC data on the following screen. Select write sequence program files, and click [Execute].
Use [Remote Operation] under [Related Functions] to instruct the PLC to RUN or STOP.

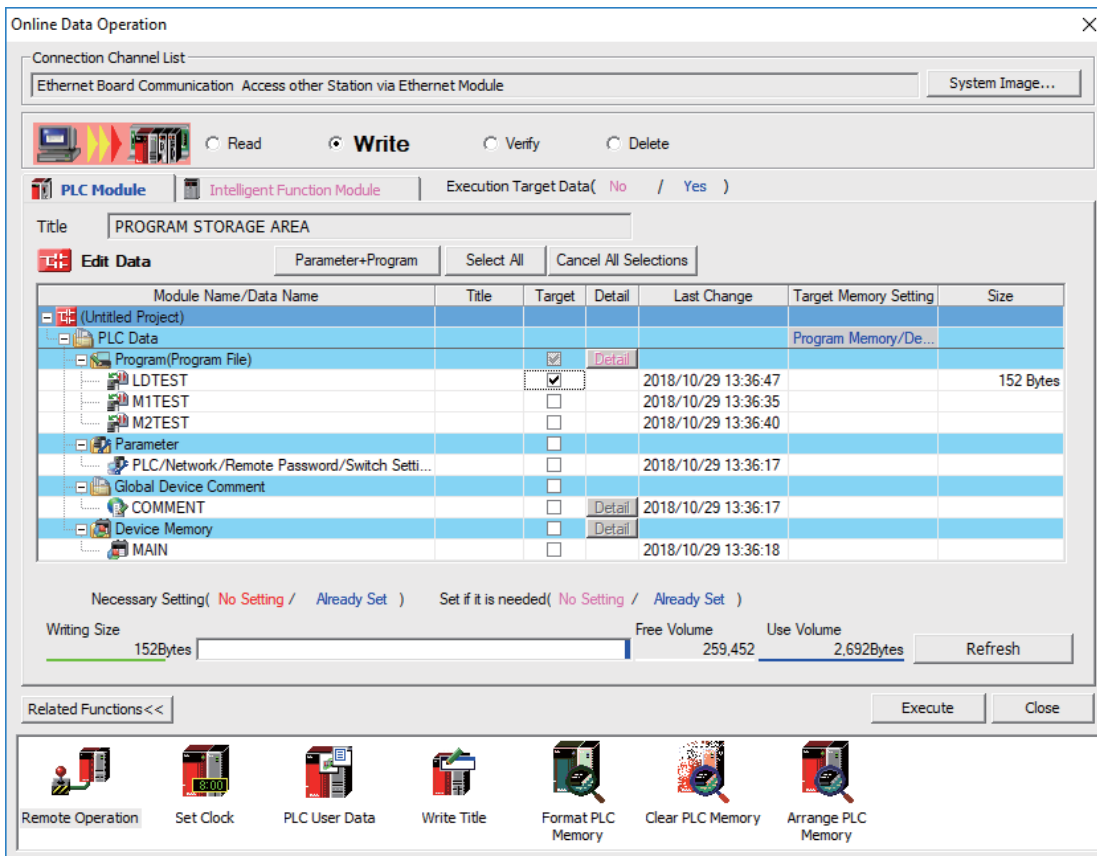

Note

- [Program Memory/Device Memory] is the only valid option for [Target Memory Setting].

Note

If an attempt is made to remove the check from parameter and write sequence programs during PLC run, the following message is displayed.

"PLC is running. Do you want to force write of the files?"

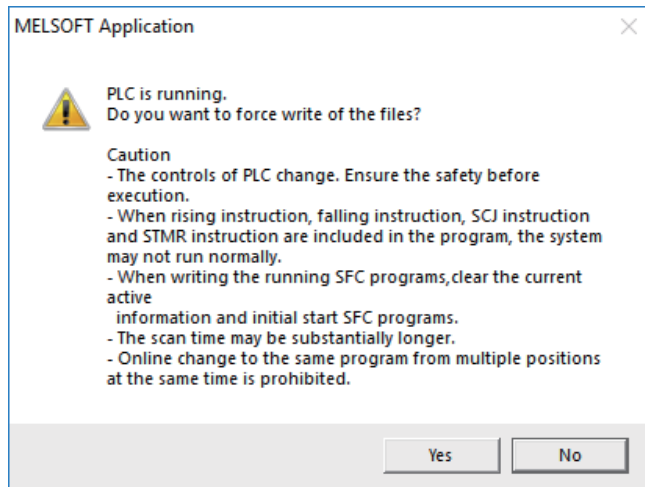

The CNC only supports writing during RUN from the [Compile] menu; if [Yes] is clicked, an error dialog is displayed and sequence programs are not written.

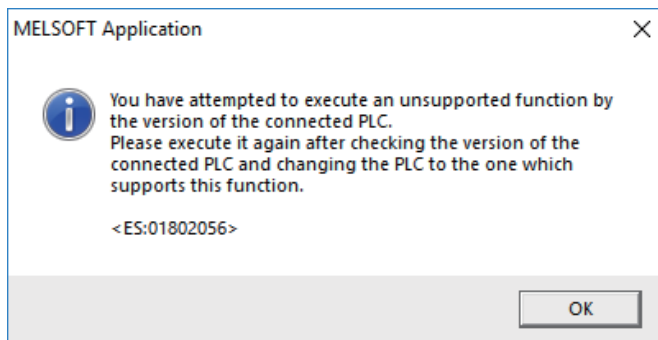

Click [No] to display the following message, and then click [Yes].

"Do you want to write to PLC after remote stop?"

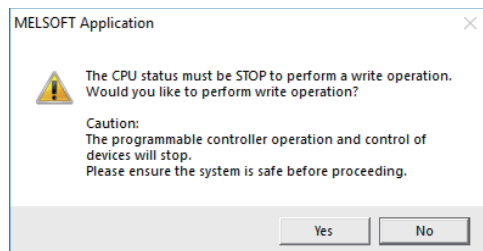

■ Operating procedure for simple projects (with labels)

The operating procedure when "use label" is set is described below.

- (1) Start the operation screen by the following operation on GX Works2.

[Online] -> [Write to PLC]

- (2) Select [Program Memory/Device Memory] in [Target Memory Setting] for [Symbolic Information] on the following screen. Select [Program Memory/Device Memory] in the target memory setting for PLC data.

Click [Parameter+Program], and then click [Execute].

Use [Remote Operation] under [Related Functions] to instruct the PLC to RUN or STOP.

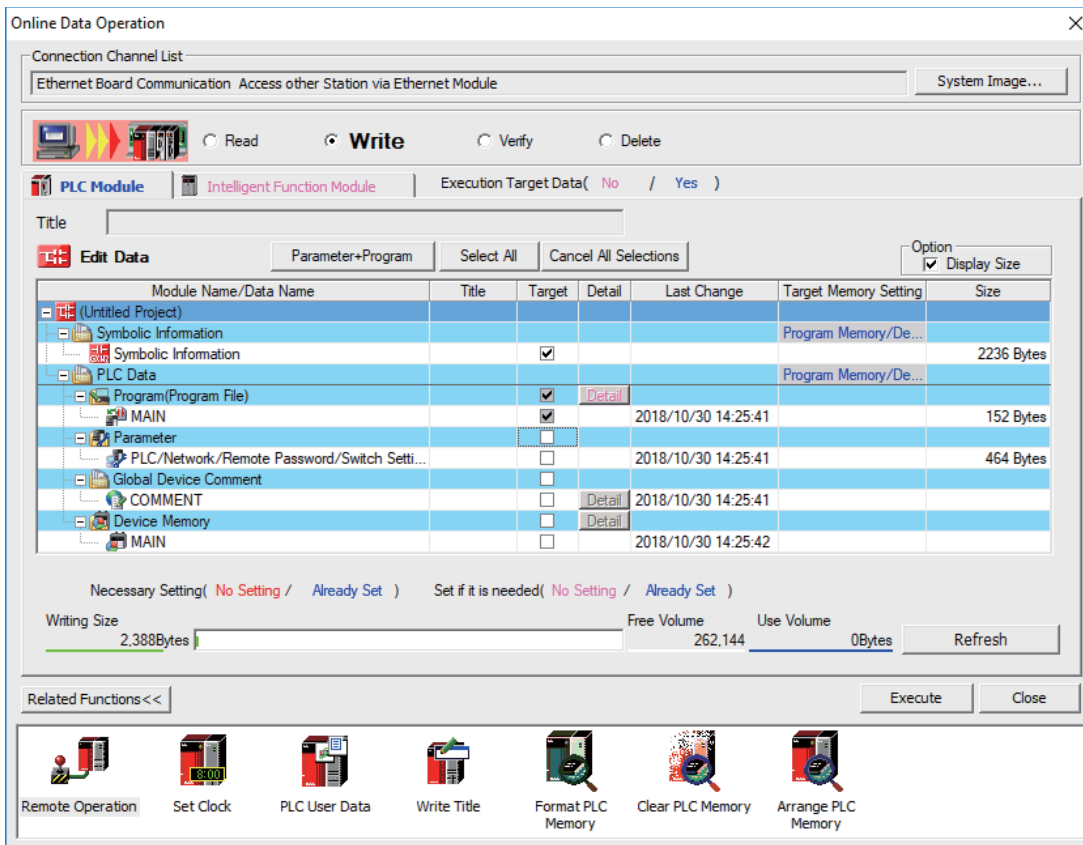

Note

- [Program Memory/Device Memory] is the only valid option for [Target Memory Setting].
- Since device memory cannot be written to the CNC controller, unselect the checkbox for device memory.
- Make sure to write parameters at the same time when the symbolic information is to be written. If parameters are not written, the project has not been compiled when the symbolic information is read.
- If an attempt is made to remove the check from parameter and write sequence programs during PLC run, the following message is displayed.

"PLC is running. Do you want to force write of the files?"

The CNC only supports writing during RUN from the [Compile] menu; if [Yes] is clicked, an error dialog is displayed and sequence programs are not written.

Click [No], and click [Yes] to the prompt "The CPU status must be STOP to perform a write operation. Would you like to perform write operation?" is displayed.

5.6.4.2 Writing Operation

When the writing of ladders to the CNC controller is executed on GX Works2, the CNC controller converts the ladders to ladder machine codes specific to CNC as they are written.

When devices and instruction formats that are not supported by the CNC controller are used, a conversion error is generated. Even if a conversion error is generated, writing is not stopped. Transfer up to the final step is completed by converting the instructions with error into NOP instruction (No operation instruction).

Note

- (1) Ladders with an error cannot be run for safety reasons.

5.6.4.3 Operation and Check on Conversion Error

■ Operation on conversion error

The following dialog is displayed on the GX Works2 screen on conversion error.

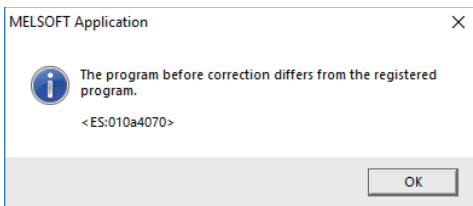

An attempt to run the PLC fails with an alarm on the CNC.

If a program file with a conversion error is displayed on the "Read from PLC" screen, the file name and title will change and be displayed as shown below.

When this program file is read to GX Works2, saved as a file named "ERRLD-00". ("ERRLD-XX": XX represents the error file number that is sequentially added from 0 in hexadecimal notation.)

Note

- (1) When developing program with labels, error file names cannot be checked on the "Read from PLC" dialog. Check the error file name on the "Delete PLC Data" screen.

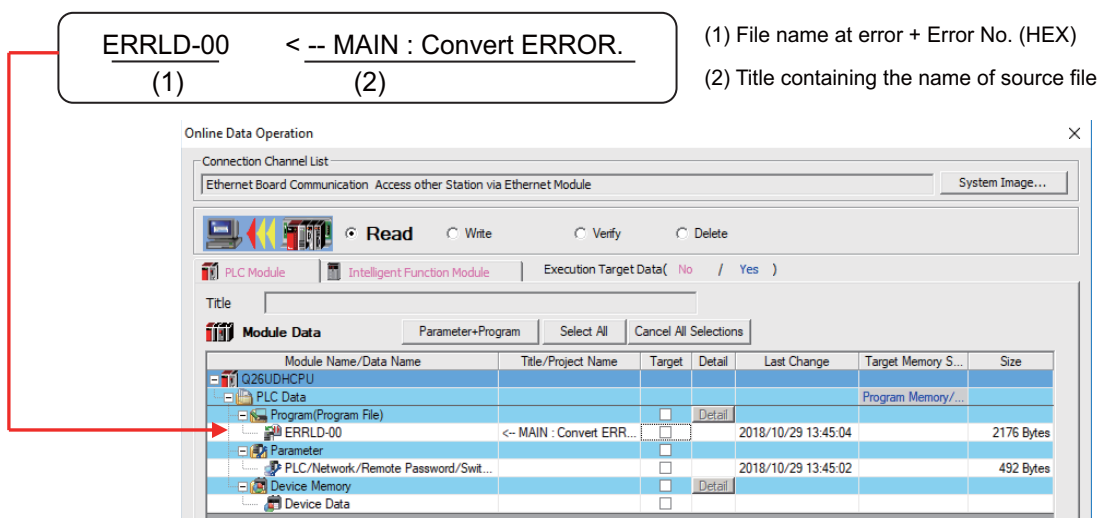

CAUTION

Do not read to and use on GX Works2 the ladder files for which a conversion error is generated. Unintended data are included, and malfunction may result.

■ How to check conversion step with an error number

Error steps can be checked using PLC verify function.

For details on PLC verify function, refer to "5.6.7 Verifying the Sequence Programs".

Verify Source: Select transfer source ladder file on GX Works2

Verify Destination: Select ladder with an error file "ERRLD-00" in the CNC controller

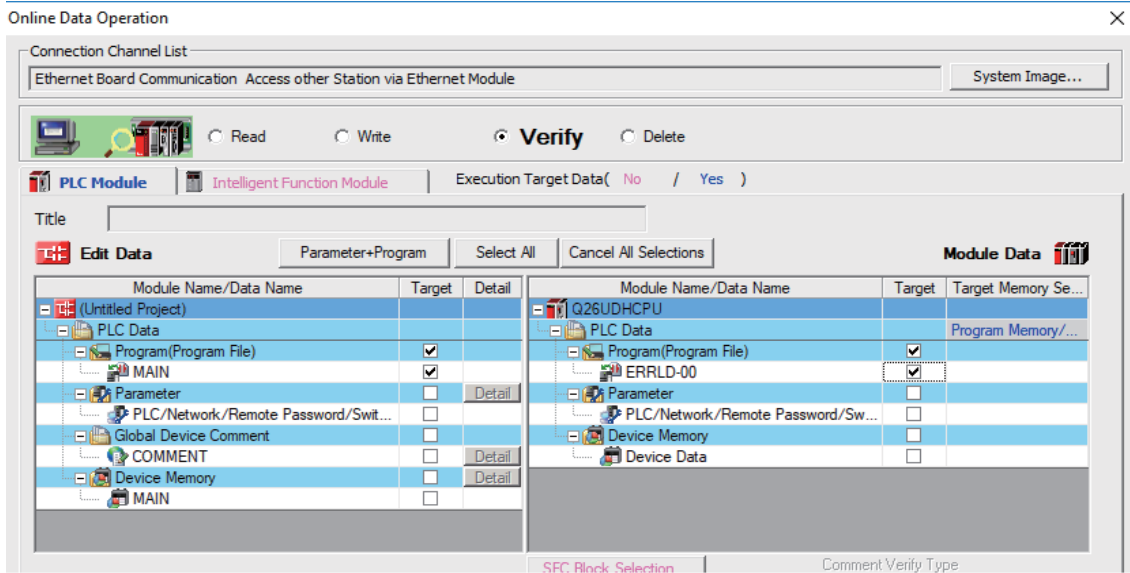

When PLC verification is executed, the verify result screen is displayed. When a file name is double-clicked, mismatched contents are displayed as shown in the example below. The NOP instructions on the CNC controller are the steps with conversion errors.

Double-click one of them to display and edit the corresponding part on the GX Works2 file.

"<Verify Source>" indicates the GX Works2 side, and "<Verify Destination>" the CNC controller side.

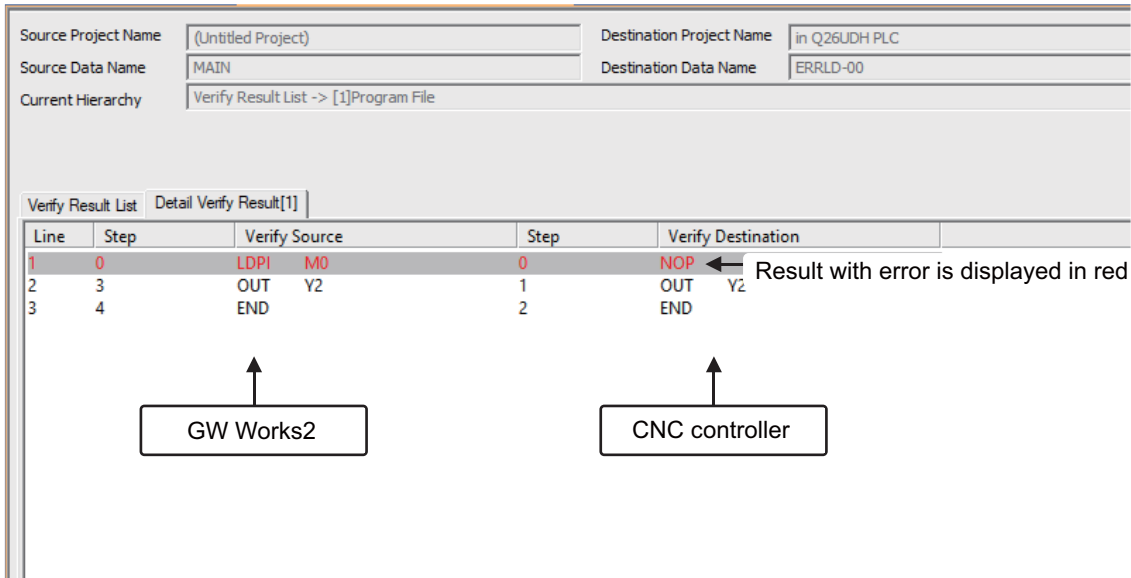

5.6.4.4 Other Operations and Checks on Error

■ Other errors

This section describes common errors that are generated when sequence programs are written.

Note that messages in displayed dialogs may not indicate the correct error status for CNC because they are for MELSEC PLC center. Status is displayed as the last 4 digits of the display number.

For details of other errors, refer to "5.13.1 List of Errors during GX Works2 Online Operation".

Status	Message	Cause	Remedy
4005 (*1)	Writing of data which exceeds the capacity of the PLC was attempted. Execute again within the capacity of the PLC.	The maximum number of steps that can be executed with NC has been exceeded.	Check the size of execution area. (Refer to "How to check size of area for execution" of this section.) Reduce the number of steps for the sequence program to be executed according to that value.
4010	Cannot write because the PLC is executing a RUN command. Stop the PLC, then execute again.	The PLC of the NC is running.	After stopping the PLC of the NC, start execution again.
4021	The applicable drive is not ready.	The specified target memory does not exist or is not in a usable status.	Change the target memory.
4029	Insufficient file capacity. Execute again after deleting unnecessary files.	An attempt was made to write a file that exceeds the storage capacity.	Examine the file structure so that the data falls within the limited capacity.
4052	The file is write protected. Change the file attributes to enable writing to the file.	The specified target memory is a write-disabled device (CNC ROM).	Specify "Program memory/Device memory" as the target memory.
4065	A mismatch occurred between the PLC and peripheral parameters. Match the parameters between the PLC and peripherals.	There is a problem in the device setting value.	Set the number of device points. (Refer to "5.5.8 Setting the Parameters")
4070	The program before correction differs from the registered program.	A ladder instruction outside the specification is included.	Execute verify to identify the problematic instructions (Refer to "5.6.4.3 Operation and Check on Conversion Error")

■ How to check size of area for execution

When "error status (4005): Execution area size over" ((* in the error list described previously) is generated, check the size of the execution area as follows. For details on execution area, refer to "PLC Programming Manual".

When [Standard RAM] is selected as [Target Memory] on the "Read from PLC" screen, the file name and the title are changed and displayed as follows. For simple projects (with labels), open the "Delete PLC Data" screen instead of the "Read from PLC" screen.

- (a) Target Memory Setting
- (b) The number of steps at execution when the title section is replaced.
The alphabet at the head of the number of steps indicates the state of parameter designation.
I: Initial; H: High speed; M: Medium speed; W: Wait
-: No parameters or parameters not stored
- (c) The total number of steps at execution. (Total of "Initial", "High speed", "Medium speed" and "Wait")
The denominator indicates the maximum size of the execution area.
When there is no parameter, the single program method is applied and "TOTAL" will not be displayed.

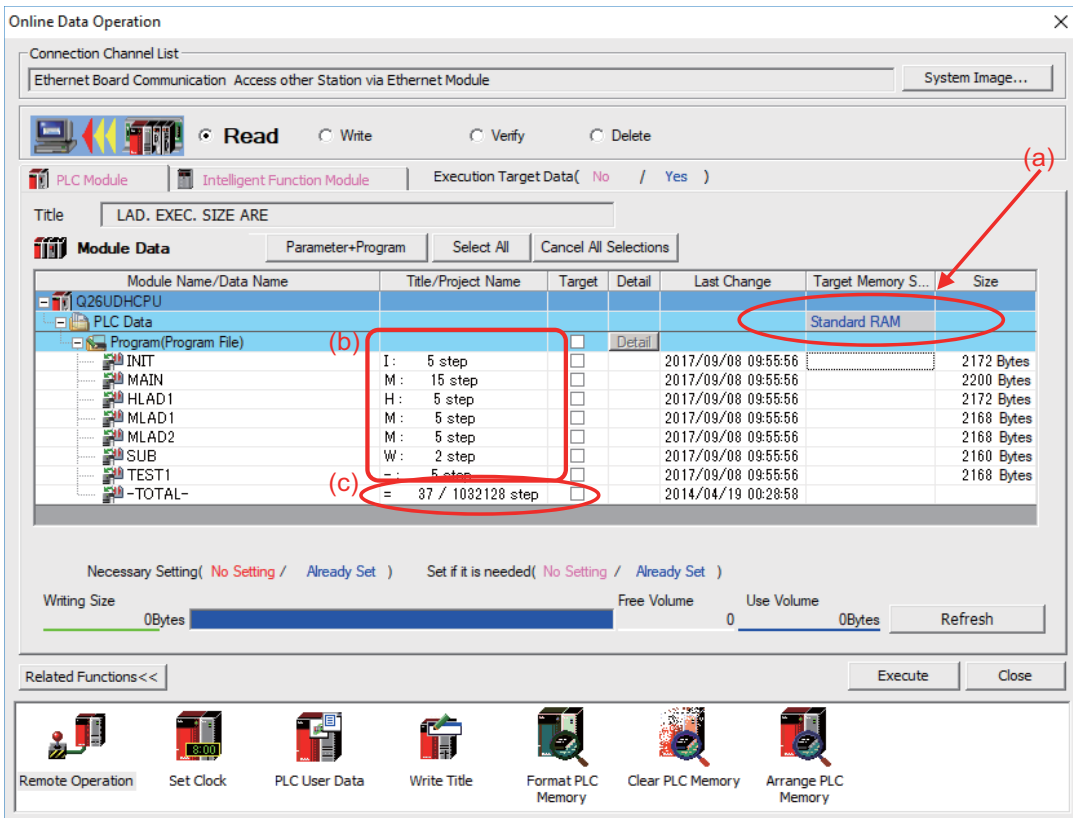

In the above screen example, adjust the size of the sequence program so that the total number of steps at execution (37) indicated in (c) is smaller than the denominator: the maximum size (1032128) of the execution area.

Note

- (1) Exercise caution not to delete files by mistake when checking the size of the execution area for simple projects (with labels).

5.6.5 Reading Sequence Programs from CNC Controller

This section describes how to read GX Works2 sequence programs from the CNC controller.

5.6.5.1 Operation Procedure

■ Operating procedure for simple projects (without labels)

The operating procedure for when labels are not used is described below.

- (1) Start the operation screen by the following operation on GX Works2.
[Online] -> [Read from PLC]
- (2) Select [Program Memory/Device Memory] in [Target Memory Setting] of PLC data on the following screen. Select read sequence program file, and click [Execute].

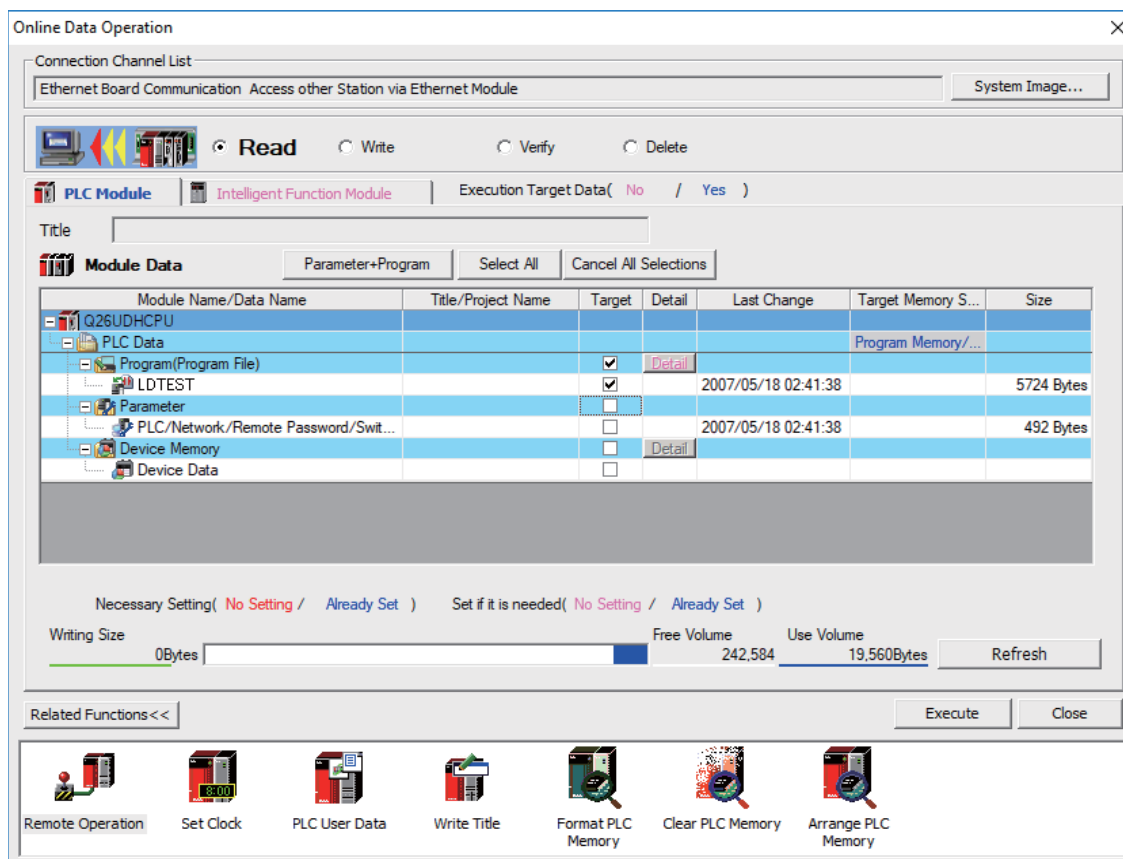

Note

- ◆ [Program Memory/Device Memory] is the only valid option for [Target Memory Setting].
- ◆ Always click [Refresh] before reading sequence programs

If there is a sequence program file of the same file name on GX Works2, the following dialog is displayed.

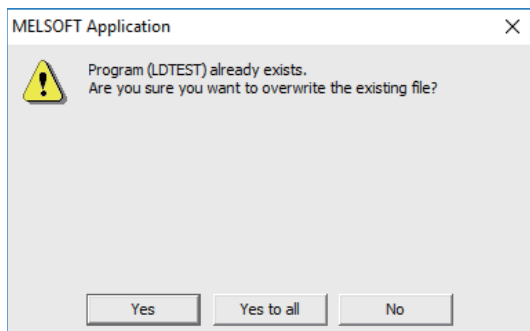

Note

- When [Yes] is clicked in the above dialog, the sequence program file on GX Works2 is overwritten and deleted. Check thoroughly before executing.

Read from PLC screen can also be used as the file list function of the CNC controller. The date and time of update and the size of each file are displayed on the right side of the file name.

■ Operating procedure for simple projects (with labels)

The operating procedure when "use label" is set is described below.

(1) Start the operation screen by the following operation on GX Works2.

[Online] -> [Read from PLC]

(2) Select [Program Memory/Device Memory] in [Target Memory Setting] for [Symbolic Information] on the following screen. Select "GX Works2 (Simple project)", and click [Execute].

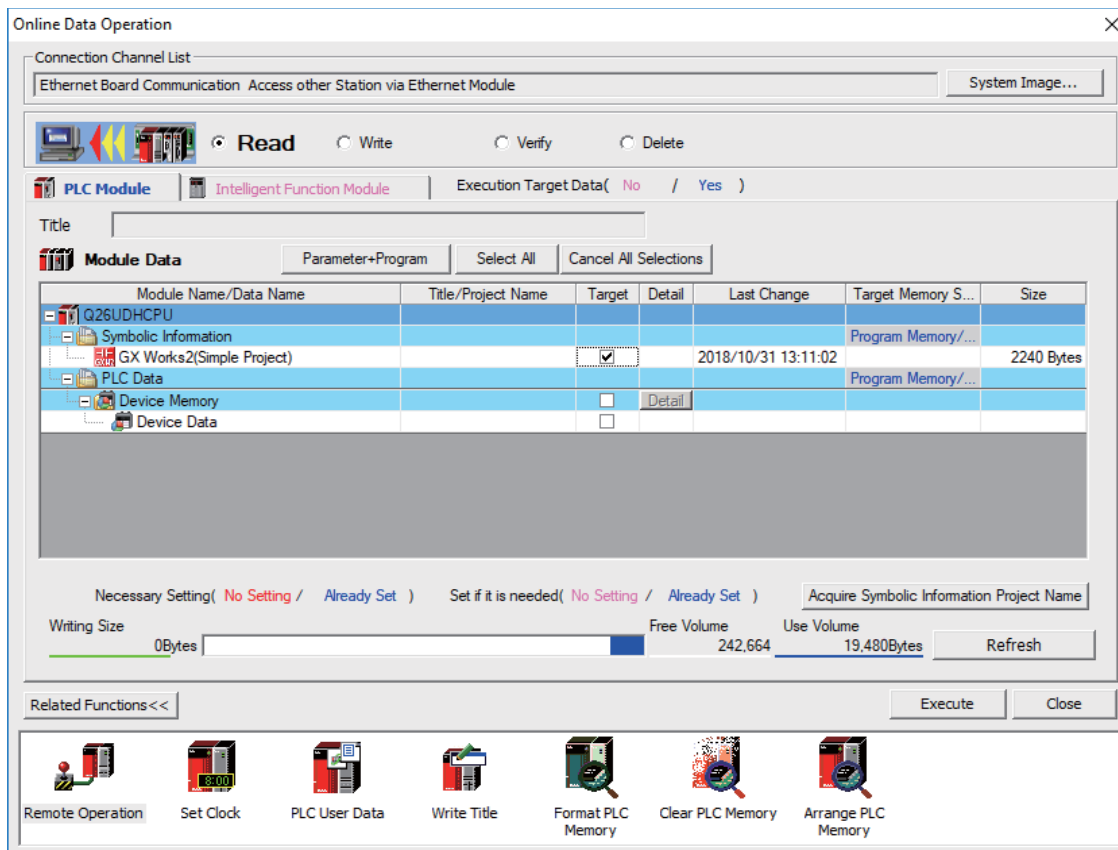

Note

- [Program Memory/Device Memory] is the only valid option for [Target Memory Setting].
- Click [Refresh] before reading symbolic information.
- For details on read parameters before reading symbolic information, refer to "5.5.8.6 Writing and Reading Parameters to CNC Controller".
- When symbolic information is read, labels and FB are also read as well as sequence programs.
- When a simple project with labels is selected, a sequence program only by itself cannot be read.

Select [Yes] when the following dialog is displayed. Sequence programs and label data are read.

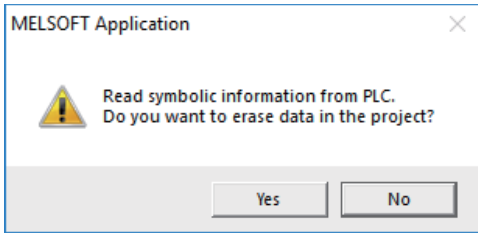

Note

- When [Yes] is clicked in the above dialog, the sequence program files, labels and FB on GX Works2, are overwritten and deleted. Check thoroughly before executing. (No prompt for overwrite confirmation is displayed even when there is a file of the same name.)

The "Read from PLC" screen can also be used as file list function of the CNC controller. The date and time of update and the size of each file is displayed on the right side of the file name.

5.6.6 Writing Sequence Programs to ROM in CNC

Sequence programs transferred from GX Works2 and built-in PLC (built-in edit function) to the CNC controller are stored in temporary storage. Data in temporary storage are erased at power OFF. (The sequence programs stored in the ROM in the CNC is enabled by powering ON the CNC controller again.)

To retain data after the CNC is powered ON again, transfer the sequence programs in temporary storage to the ROM in the CNC according to the following procedure.

This section describes how to transfer sequence programs in the temporary storage the CNC controller to the ROM in the CNC on GX Works2.

For the user safety sequence, ROM write operation is not required.

Note

- (1) When the sequence programs in temporary storage (RAM in CNC) are updated, but not written to the ROM in the CNC, "ROM-Write incomplete" error is generated.

5.6.6.1 Operation Procedure

(1) Start the operation screen by the following operation on GX Works2.

[Online] -> [Export to ROM Format]

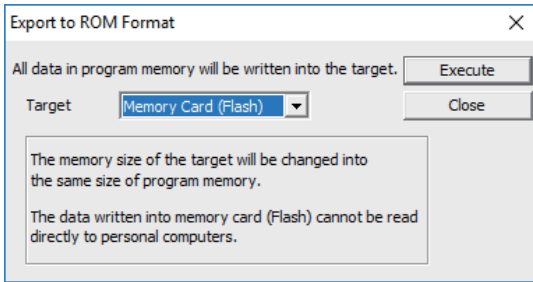

Note

- Only [Memory card (Flash)] is valid as [Target].

(2) Click [Execute] to display the following dialog, and click [Yes].

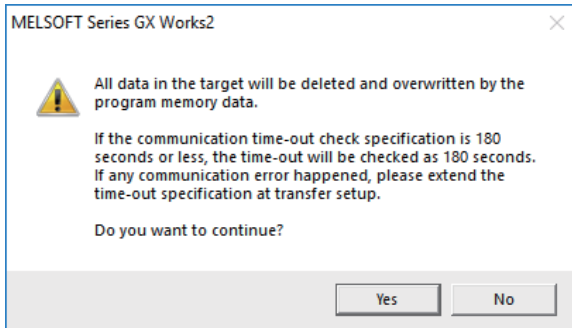

Note

- When [Yes] is clicked in the above dialog, sequence program files on the ROM in the CNC the CNC controller are over-write and deleted. This should be done with extreme caution.

(3) The operation is completed when the following dialog appears. Click [OK].

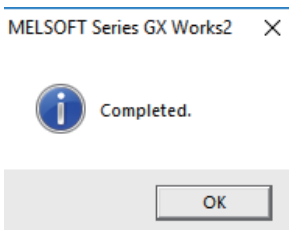

5.6.7 Verifying the Sequence Programs

This section describes how to verify sequence programs between the CNC controller and GX Works2.

5.6.7.1 Operation Procedure

(1) Start the operation screen by the following operation on GX Works2.
 [Online] -> [Verify with PLC]

(2) Select the sequence program file to verify on the following screen, and click [Execute].

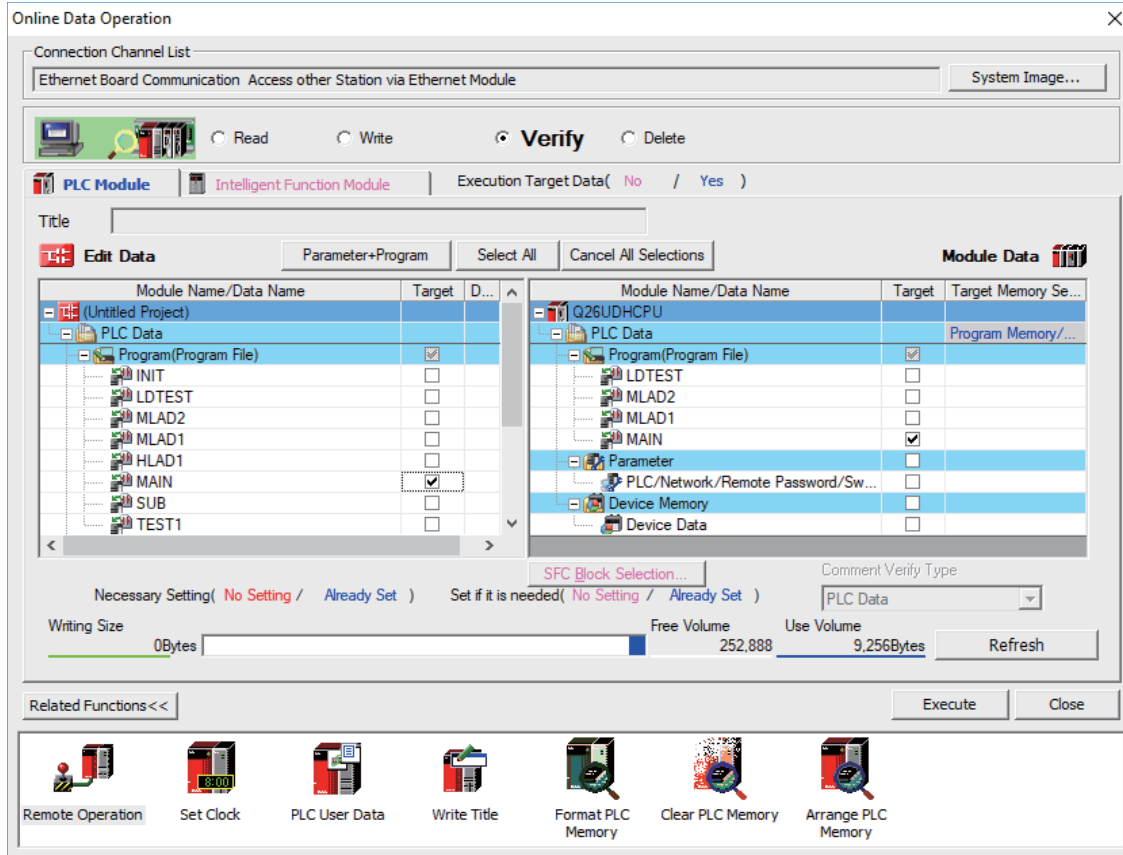

Note

- ◆ The memory that has the file to be verified is valid as [Target Memory Setting].

When verification finishes, the verify result screen is displayed. Double-click a file name to display on the screen the detailed result as shown below. Unlike GX Developer, matched places are also displayed on GX Works2. Mismatched contents are displayed in red. Click [Find/Replace] - [Next Unmatch] and [Find/Replace] - [Previous Unmatch] to find previous and next mismatch places. Double-click mismatched contents to display and edit the corresponding parts in the GX Works2 file.

Since the verification with PLC is executed for actual ladder (ladder with labels and functional blocks compiled) after compile, sequence programs with labels displayed cannot be verified.

Source Project Name	(Untitled Project)	Destination Project Name	in Q26UDH PLC
Source Data Name	MAIN	Destination Data Name	MAIN
Current Hierarchy	Verify Result List -> [1]Program File		

Line	Step	Verify Source	Step	Verify Destination
1	0	LD M0	0	LD M0
2	1	OUT Y2	1	OUT Y2
3	2	LD M2	2	LD M2
4	3	OUT Y3	3	OUT Y3
5	4	LD M3	4	LD M3
6	5	MOV K100 D0	5	MOV K10 D0
7	7	LD D0.1	7	LD D0.1
8	8	AND D0.0	8	AND D0.0
9	9	OUT Y50	9	OUT Y5
10	10	END	10	END

Note

- (1) The verification result is displayed by mnemonic codes as shown in the figure above regardless of the setting of programming language (ladder diagram or ST language).

5.6.8 Executing Ladder Program Writing during RUN

Ladder program writing during RUN (or RUN write/online change) enables to edit and change the sequence program from GX Works2 without stopping PLC operation.

When a ladder program is to be written to a CNC, use the writing command (Online program change) in the [Compile] menu of GX Works2. The ladder program writing during RUN cannot be executed on the [Write to PLC] screen.

For the user safety sequence, ladder program writing during RUN cannot be used.

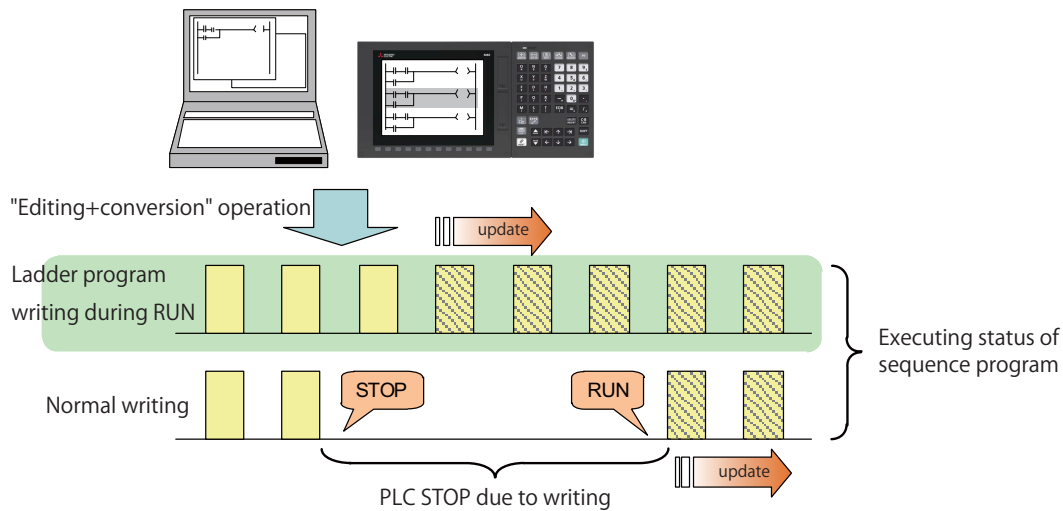

⚠ CAUTION

Only the person who knows well about sequence programs can execute sequence program writing during RUN. When the RUN write is enabled, the modification will be immediately effective after the data editing and conversion. The machine might operate in unexpected way when the sequence program is incomplete. Consider well the influence of the modification in advance. Also, always make sure that the system's safe operation with the sequence programs.

5.6.8.1 Execution Procedures of Ladder Program Writing during RUN

Ladder program execution writing during RUN is executed in the following procedure.

Execution procedures		Description	Reference
(1)	Set parameters of CNC	By setting the bit selection parameter of CNC, enable the ladder program writing during RUN.	5.6.8.2 Setting Ladder Program Writing during RUN
(2)	Set the options of GX Works2		5.6.8.8 Option Setting Screen for Ladder Program Writing during RUN (Online Change)
(3)	Read out the sequence programs	The sequence programs are read out from CNC to GX Works2	5.6.5 Reading Sequence Programs from CNC Controller
(4)	Edit the sequence programs		GX Works2 Operating Manual
(5)	Write the sequence programs during RUN	The sequence programs are written to CNC during RUN.	5.6.8.7 Operation method on the GX Works2

5.6.8.2 Setting Ladder Program Writing during RUN

Turn ON the corresponding bit selection parameter and turn the power ON again to enable ladder program writing during RUN.

[Bit selection parameter]

# No.	Bit	Item	Description	Setting range	Standard value
6455	Bit 6	Enable ladder program writing during RUN (in high-speed processing)	Select whether to permit ladder program writing during RUN to built-in PLC (in high-speed processing). 0: Not permit ladder program writing during RUN 1: Permit ladder program writing during RUN	0,1	0
6455	Bit 7	Enable ladder program writing during RUN	Select whether to permit ladder program writing during RUN to built-in PLC (except in high-speed processing). 0: Not permit ladder program writing during RUN 1: Permit ladder program writing during RUN	0,1	0

Note

- (1) These parameters will be enabled after the power is turned ON again.
- (2) When the multi-project function is enabled, the enabled or disabled status of ladder program write during RUN is switched for all the projects.
- (3) Turning ON "#6455 Bit6 (Enable ladder program writing during RUN (in high-speed processing))" alone does not take effect.
When setting "#6455 bit 6" to "1", also set "#6455 bit 7 (Enable ladder program writing during RUN)" to "1".
- (4) When "Enable ladder program writing during RUN (in high-speed processing)" is set to "1", a high-speed processing program will use 8,000 steps of execution area.
Thus, if the program size before the setting change is close to the maximum, the error of insufficient execution area may occur after the setting change.

5.6.8.3 PLC Data Available for Ladder Program Writing during RUN

The following shows the PLC data which can be stored in CNC controller and available for ladder program writing during RUN.

[Data type available for RUN write]

Data category	Data type	GX Works2	GX Developer	Built-in PLC (built-in edit function)
Sequence programs (independent program method)	-	×	×	×
Sequence programs (Multi-program method) (*1)	High-speed process	○ (*2)	○ (*2)	○ (*2)
	Main process	○	○	○
	Initialization process	○	○	○
	Standby process	○	○	○
Symbolic information		○	○	×
Parameter Device comments Message data	-	×	×	×

(*1) Only the program whose execution order has been registered in the parameter is available.

(*2) There are some restrictions on the contents of high-speed processing programs. For details, refer to later precautions.

5.6.8.4 Data Unit for Writing

The following table shows the available data units for the ladder program writing during RUN and specifications of an upper limit of each writing are as follows. Ladder blocks are written at the conversion after edited. When the ladder program writing during RUN is executed from the ladder edit screen, either the single block or the multiple blocks will be written in the ladder program. The writing method to be executed is automatically determined based on the standard stated in (*1) below the table; therefore, the method cannot be selected by users. The ladder program cannot be written to PLC on a file basis with the operation such as selecting [Online] - [Write to PLC].

[Available data units for the ladder program writing during RUN]

Data units for writing	GX Works2	GX Developer	Built-in PLC (built-in edit function)
Ladder program writing during RUN of single block	○ 512 steps	○ 512 steps	○ 512 steps
Ladder program writing during RUN of multiple blocks(*1)	○ 64 blocks Total 1024 steps	○ 64 blocks Total 1024 steps	×
Ladder program writing during RUN in file units	×	×	×

(*1) For GX Works2, when you edit the definition of FB where multiple instances exist in a single program, the ladder program writing during RUN of multiple blocks will be applied. When you add or delete FB instance, the ladder program writing during RUN of single block will be applied.

For GX Developer, when you edit the definition of FB where an instance exists, multiple-block writing in ladder program during RUN will be applied. When you add or delete FB instance, single-block writing in ladder program during RUN will be applied.

5.6.8.5 Available Number of Steps for Writing

Ladder program writing during RUN is available until the total number of steps needed for executing the sequence program set in the parameter reaches the maximum number of steps of the program execution area. (For the maximum number of steps in the sequence program execution area, refer to the "PLC Programming Manual".)

Note that when RUN write in high-speed processing is enabled, the number of steps in the sequence program execution area will be as shown below.

■ When the multi-project function is disabled

The maximum number of executable steps in a high-speed processing is fixed to 4,000. If the number of steps exceeds 4,000, NC will show an alarm and RUN write will be disabled.

In addition, the maximum number of executable steps in a main processing program decreases by 8,000 steps.

The following shows the relation between the settings and available number of steps for RUN write.

[Settings and available number of steps]

Setting of "Enable ladder program writing during RUN"		Number of steps available for execution	
High-speed process	Main process	High-speed processing program	Main processing program
ON	ON	High-speed processing program ≤ 4,000 steps	Main processing program ≤ (Number of execution area steps - 8,000 steps.)
OFF	ON	(Total number of steps in high-speed processing program and main processing program) ≤ Number of steps in execution area	
OFF	OFF		

■ When the multi-project is enabled

The maximum number of executable steps in a high-speed processing program is fixed to 4,000 in total of all the projects, regardless of the multi-project parameters. If the number of steps exceeds 4,000, NC will show an alarm and RUN write will be disabled.

In addition, the whole sequence program execution area decreases by 8,000 steps. The number of steps of sequence program storage area per project is calculated by subtracting 8,000 steps from the total size.

The following shows the relation between the settings and available number of steps for RUN write.

[Settings and available number of steps]

Setting of "Enable ladder program writing during RUN"		Number of steps available for execution	
High-speed process	Main process	High-speed processing program	Main processing program
ON	ON	[total of whole project] High-speed processing program ≤ 4,000 steps	[per project] Main processing program ≤ ((Number of execution area steps - 8,000 steps) x project percentage)
OFF	ON	[per project]	(Total number of steps in high-speed processing program and main processing program) ≤ (Number of steps in execution area multiplied by project ratio)
OFF	OFF		

If high-speed processing program does not need to be written during RUN, the execution steps for a sequence program in main processing program can be increased by setting OFF the bit selection parameter "Enable ladder program writing during RUN (in high-speed processing)".

5.6.8.6 RUN Write Target Storage Area

The following table indicates the available storage areas for RUN write.

The operation target of RUN write is temporary memory storage. The RUN write is reflected in the PLC processor execution area at the same time and is carried out.

A write to the storage area (in CNC) needs to be done separately using the ROM write operation. ROM writing operation is available while PLC is running.

[RUN write target storage area]

Storage area	RUN write availability for each development environment		
	GX Works2	GX Developer	Built-in PLC (built-in edit function)
Temporary memory storage (RAM in CNC)	○ (when converted)	○ (when converted)	○ (when converted)
Storage for execution	○ (when converted)	○ (when converted)	○ (when converted)
storage area (ROM in CNC)	× (*1)	× (*1)	× (*1)

(*1) Storage area is not updated at the time of conversion. A write to the storage area (in CNC) needs to be done separately using the ROM write operation.

5.6.8.7 Operation method on the GX Works2

There are three ways to execute ladder program writing during RUN with GX Works2.

- Executing [Compile] [Online program change].
- Set the options for RUN write in "Options" window before executing conversion.
- Execute conversion in "Monitor (write mode)" window.

Common operation while executing conversion for ladder program writing during RUN

Conversion procedure in RUN write is the same in any methods. Regardless of PLC status, either "RUN" or "STOP", operation procedure is the same. When "Conversion" is executed, the following dialog box will be displayed.

The dialog displayed for a simple project (without labels)

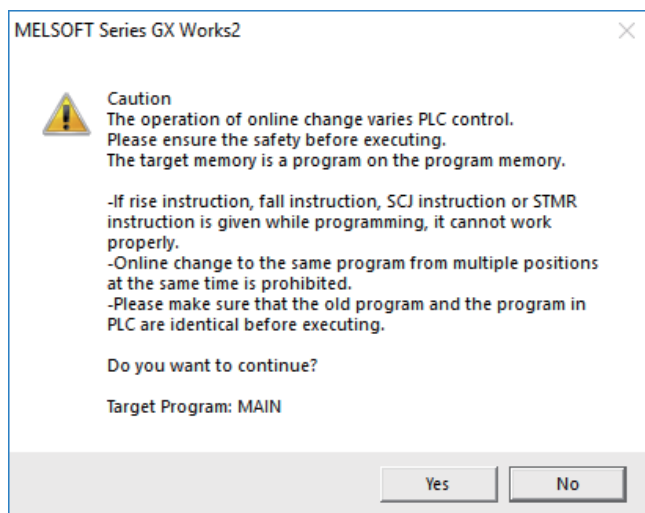

The dialog displayed for a simple project (with labels)

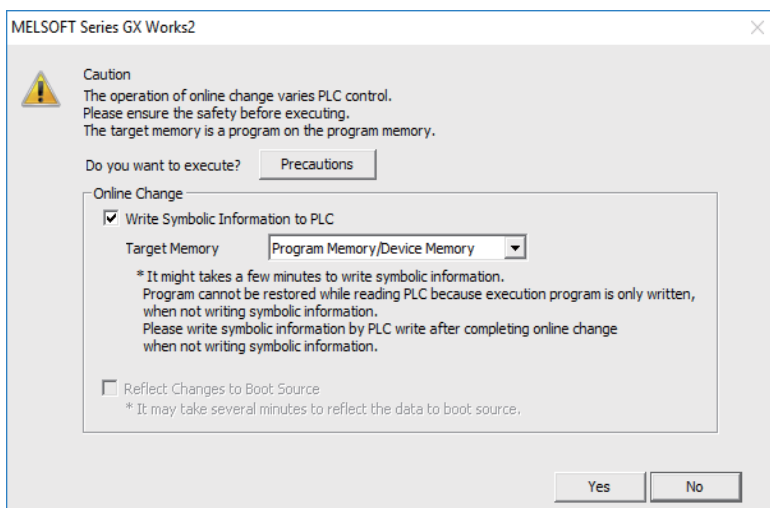

Note

- The symbolic information must be written together with sequence programs during RUN. Otherwise, a mismatch occurs between the symbolic information and sequence programs when "Read from PLC" is executed.

- (1) Pressing [Yes] button executes the RUN write, displaying the following dialog box after writing process is completed. Processing time of RUN write depends on the total number of steps used in the ladder programs and the points where the steps are written in.

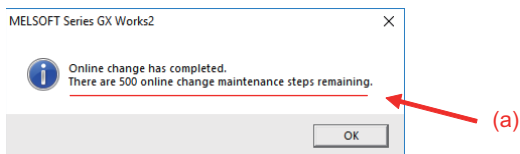

"There are xxx online change maintenance steps remaining." pointed by (a) is displayed in the completion dialog box, but the CNC does not use such kind of steps. Ignore this message.

- (2) Pressing [No] button cancels the conversion and the RUN write, displaying the following dialog box.

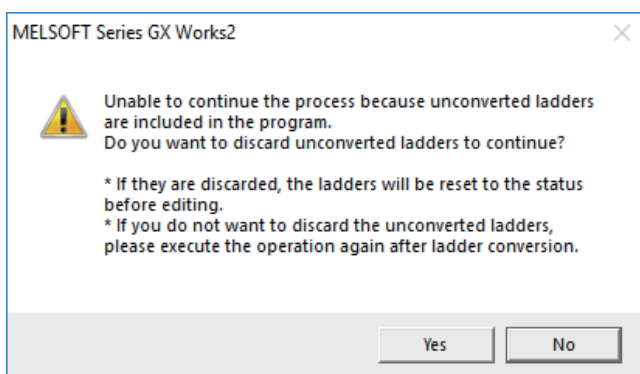

If you click [Yes], the unconverted ladder is canceled and the previous ladder display returns.

If you click [No], the unconverted ladder is retained.

Executing "Online program change" (Ladder program writing during RUN)

Online program change (Ladder program writing during RUN), dedicated to conversion writing, is provided separately from common conversion. After editing ladder program as usual, do either of the following operations for conversion. Further operation is the same as that in "Common operation while executing conversion for ladder program writing during RUN".

- Select [Compile] - [Online program change].
- Press "shift" and "F4" keys simultaneously.

Setting options for ladder program writing during RUN before executing conversion

The following explains how to change the settings to execute ladder program writing during RUN instead of common conversion.

Display the setting screen by following operation.

[Tool] - [Options] - [Online change]

Check the option "Execute online change by Compile" and then click [OK].

After setting this item, ladder program writing during RUN can be executed with the normal conversion operation. The operation after conversion writing is the same as described in the section "Common operation while executing conversion for ladder program writing during RUN".

Executing conversion in "Monitor (write mode)"

Monitor (Write mode) is the mode that enables editing, conversion, and conversion writing while executing ladder monitor. Do either of the following operations:

Select [Online] - [Monitor] - [Monitor (Write mode)] or press "Shift" and "F3" keys simultaneously.

The following confirmation dialog box will be displayed. Clicking [OK] starts the preparation for the monitor (write mode): compares the program on the GX Works2 ladder screen with the stored files in NC.

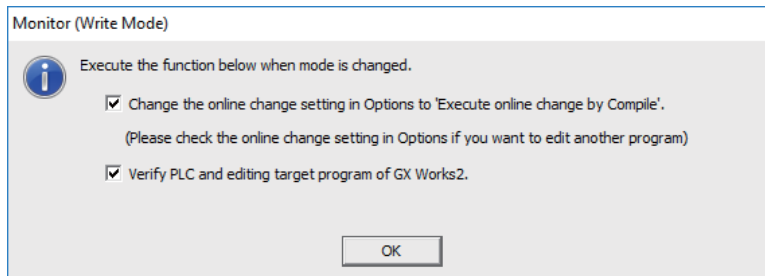

After the comparison, ladder editing can be executed on the ladder monitoring screen. RUN write can also be executed with the common conversion operation. Further operation is the same as described in the section "Common operation while executing conversion for ladder program writing during RUN".

Operation when ladder program writing during RUN is disabled

Without settings for enabling ladder program writing during RUN, the following error dialog box appears at the RUN write execution.

When RUN write is executed with the CNC system which does not support the function, the same dialog box appears. After any operation of "Executing "Online program change" (Ladder program writing during RUN)", "Setting Options for Ladder Program Writing during RUN before Executing Conversion" or "Executing Conversion in "Monitor (Write mode)"", when "Yes" is pressed on the confirmation dialog box described in the section "Common operation while executing conversion for ladder program writing during RUN", the following error dialog box appears.

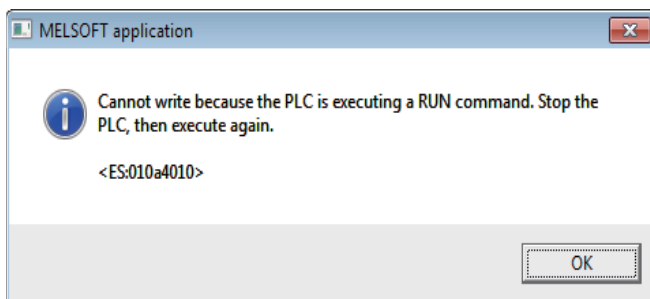

Pressing [OK] displays another error dialog box as follows.

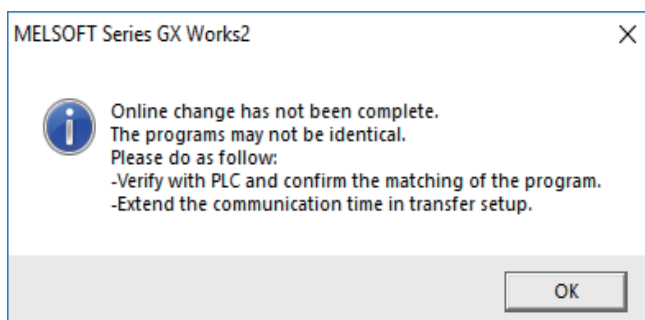

5.6.8.8 Option Setting Screen for Ladder Program Writing during RUN (Online Change)

When the ladder program writing during RUN is to be executed to a CNC, display the setting screen by selecting [Tool] - [Options] - [Online Change] to set the following optional items.

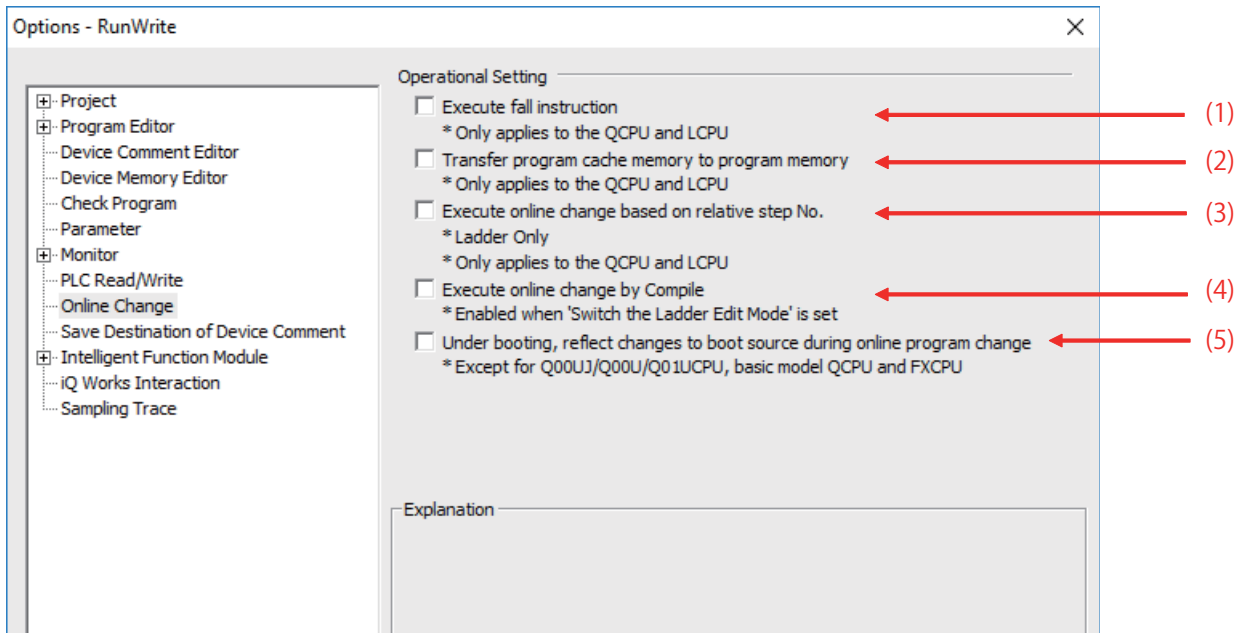

(1) Execute fall instruction

Do not check this item. Regardless of the setting, the first fall instruction is not executed in a CNC after the setting is changed.

(2) Transfer program cache memory to program memory

Check this item.

When this item is not checked, the following dialog is displayed while executing ladder program writing during RUN.

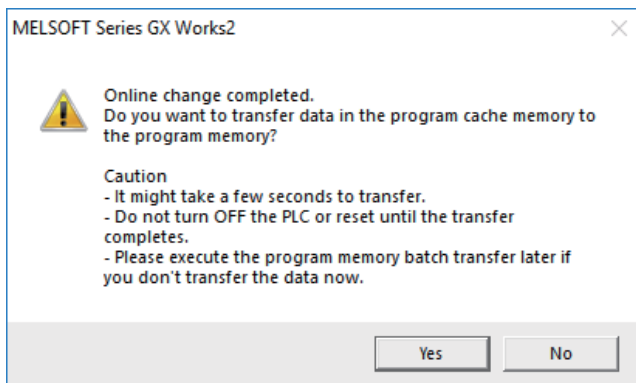

CNC performs RUN write only regardless of whether you choose "Yes" or "No".

(3) Execute online change based on relative step No.

Do not check this item. "Relative step No. by pointer" is not supported.

When a pointer (P) is included in the ladder block to be written during RUN with this item checked, an error will occur.

(4) Execute online change by Compile

Refer to "Setting Options for Ladder Program Writing during RUN before Executing Conversion" in "5.6.8.7 Operation method on the GX Works2", and check this item as necessary.

(5) Under booting, reflect changes to boot source during online program change

Do not check this item. Booting operation is not supported by CNC.

5.6.8.9 Precautions

Restrictions on program configuration

- (1) Limitations on independent program method
Ladder program writing during RUN is not available for the sequence program in independent program method. Bit selection parameter setting is not available. Still, program execution is available.
- (2) Limitations on high-speed processing program
If you set the bit selection parameter to enable "ladder program writing during RUN (in high-speed processing)", a write to a high-speed processing program is enabled during RUN. However, the following limitations are imposed:
 - (a) Available execution steps
The following is the maximum number of available execution steps for a high-speed processing program. If the number has been exceeded during RUN write, an error will occur.
 - The maximum number of available execution steps is 4,000.
(When the multi-project function is enabled, the total number of steps for all projects will be 4,000).
 - 8,000 steps of execution area will be used regardless of the size of high-speed processing program.
 - (b) Available number of local labels
The following is the number of available local labels in a high-speed processing program. If the number has been exceeded during RUN write, an error will occur.
 - The maximum number of local labels is 256.
(When the multi-project function is enabled, the maximum number of local labels will be 256 per project.)
 - If the number of local labels is set to 256 or less, the set number will be the maximum number of local labels.
 - (c) Use of common pointers in high-speed processing program
RUN write is disabled when the common pointer is used in a high-speed processing program. In this case, the bit selection parameter for enabling RUN write will be disabled. Still, program execution is available. If you perform RUN write for a high-speed processing program, use a local pointer only. The following is an example of the use of common pointer for subroutine call from standby processing program.

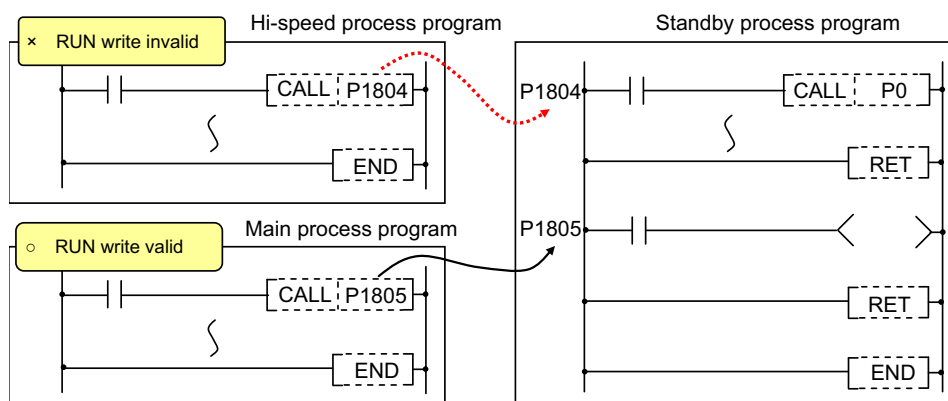

- (3) Limitations when the multi-project function is enabled
RUN write cannot be performed to different projects through multiple development tools at the same time. If attempted simultaneously, an error will occur. Try RUN write again after shifting the timing.
- (4) Limitations on independent program method
When the multi-project function is enabled and a sequence program in independent program method is included in any project, the ladder program writing during RUN cannot be executed for high-speed processing program in all projects.

Precautions for command operation in ladder programming writing during RUN

(1) When commanding rising/ falling edge

When rising or falling edge is commanded in ladder program writing during RUN, the following action will be taken after the command. The rising/falling edge may not always be executed in the first processing cycle due to the change of operation path such as subroutine call or jump junction.

	The first execution after change	The second execution after change
Rising/falling commands in contact system LDP, LDF, ANDP, ..., MEP, MEF, ... PLS, PLF, FF, MOVP, ~ P, ...	Command status is OFF	Normal execution

(2) When a device is deleted in the program

If an output command is deleted in the program, the output status of the device designated by the command will be kept as before the deletion.

(3) When a program error occurs in RUN write

When a program error occurs in the process of RUN write, the display of the error step may be inaccurate regardless of the relation of the command and the error point.

(4) Actual updating timing of program in RUN write

An updated program may not be executed in the cycle right after the RUN write (after executing the ladder conversion). The actual execution of the updated program may be delayed by a few or a few dozens cycles, because the processing time of RUN write depends on the total number of steps used in the sequence programs and the points where the steps are written in.

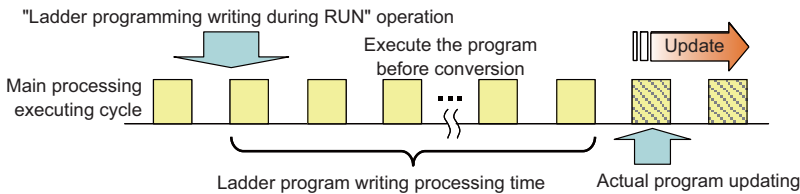

Other precautions

(1) Number of steps that can be written during RUN

Up to 48 lines of ladders can be edited and converted in GX Works2, GX Developer and PLC on-board edit function.

For the ladder program writing during RUN of a single block, ladder blocks to be written at a conversion include the block between the edited ones. Up to 512 steps can be written during RUN at a conversion.

For the multiple-block writing in ladder program during RUN, when the two edited program blocks are apart from each other, the block(s) between the two blocks will not be written. Up to 64 blocks can be written during RUN at a conversion and up to 1,024 steps can be written in the total number of the blocks.

For GX Works2, when you write multiple FB instances in a single file during RUN, the ladder program writing during RUN of multiple blocks is executed. In any other case, the ladder program writing during RUN of a single block is executed.

[When editing two or more detached ladder blocks]

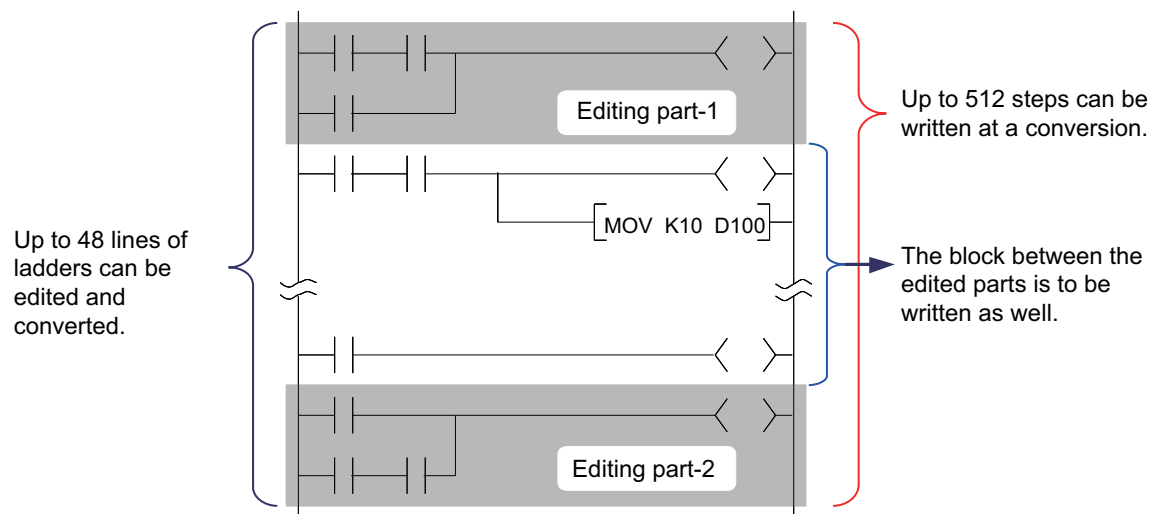

[When editing multiple FB instances]

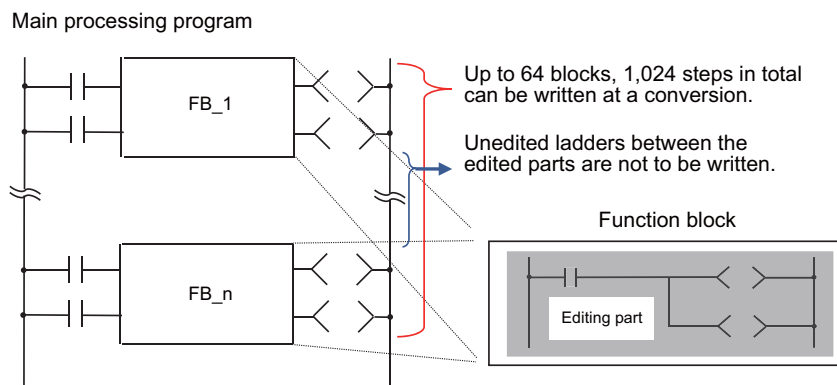

(2) Change of processing time in writing during RUN

The processing time until ladder program writing during RUN completion depends on the total number of steps used in the sequence programs during RUN and the points where the steps are written in. The process takes up to several minutes. Note that the longer processing time may take when FBs are to be written during RUN.

(3) Change of startup interval of a sequence program in writing during RUN

The startup interval of a sequence program which is currently running may become slower depending on the total number of steps used and step positions to be written. Especially when the ladder program writing during RUN is executed on a project with labels, the startup interval tends to become slower.

(4) Ladder program writing during RUN after compiling all programs

Since compiling all programs is required after any of the following operations is performed, ladder program writing during RUN cannot be executed.

- ♦ Changing common pointer No. or the device setting in [PC parameter]
- ♦ Changing the automatically-assigned device setting
- ♦ Changing PLC Type
- ♦ Changing project type
- ♦ Performing "Read from PLC" without creating or opening a new project

Error occurs at ladder program writing during RUN

If an error occurs at ladder program writing during RUN, refer to "5.13.1 List of Errors during GX Works2 Online Operation" to find out the causes and remedies.

When an error occurs, check if the ladders match with the ones in GX Works2 by selecting [Online] - [Verify with PLC], as the ladders in CNC may have changed. When they do not match, the ladder program writing during RUN cannot be executed. After reading ladders by selecting [Online] - [Read from PLC], reedit the ladders and then execute ladder program writing during RUN.

5.6.9 Monitoring Sequence Programs

The monitoring of sequence programs has no operation specific to Mitsubishi Electric CNC. For details on operating procedure, refer to "GX Works2 Operating Manual (Common)". For details on functions that can be used, refer to "5.3.6 Function Support Status (Online)". This section provides the overview of the operating procedure and cautions.

5.6.9.1 Operation Procedure

Start monitoring by the following operation on GX Works2.

- (1) Display sequence programs to be monitored, and move to the ladder to be monitored.
- (2) Start monitoring by either of the following operations.
Select [Online] - [Monitor] - [Monitor Mode] or press "F3" key.
- (3) Stop monitoring by either of the following operations.
Select [Online] - [Monitor] - [Monitor Mode] or press "Alt" and "F3" keys simultaneously.

Note

- (1) When the sequence programs running on the CNC controller and the sequence programs displayed on GX Works2 are different, errors are not generated even if monitoring is executed, and monitoring appears to continue normally.
Before executing monitoring, ensure that sequence programs in the CNC controller and GX Works2 are the same.

5.7 Developing Structured Project

This chapter provides the overview of simple projects and the development procedure focusing on those specific to Mitsubishi Electric CNC.

For the user safety sequence, refer to "M800/M80 Series Smart safety observation Specification manual".

For details of the program types that can be used in structured project, refer to "5.2.1 Support Status of Project Types, Program Types and POU's".

As unique features of structured project, function blocks (FBs), functions (FCs) and user library can be used. The nesting level of FB within FB differs depending on the program language. (Refer to "5.11.4 Restrictions".) Programs cannot be input/output in the CSV file format. For details on labels, refer to "5.10 Creating Label"; for details on FB, refer to "5.11 Creating Function Block".

For details on how to use FCs and user library, refer to "GX Works2 Operating Manual (Common)" and "GX Works2 Operating Manual (Structured Project)".

5.7.1 Overview of Structured Project

Programs can be created based on structured programming in this project type. By segmenting the control functions and creating components from commonly used parts of programs, this type of programming (structured programming) is easy to understand visually, and created components are highly reusable to other programs.

In structured project, sequence programs can be created using ladder diagram or ST language.

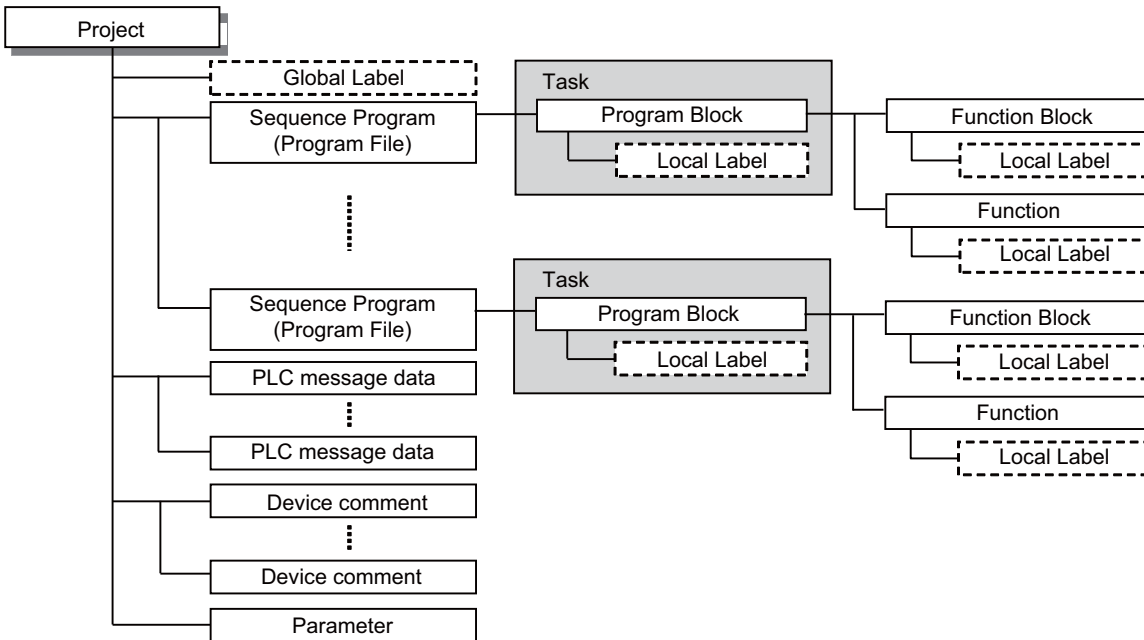

Item	Description
Sequence programs (Program file)	Sequence program (user PLC) for Mitsubishi Electric CNC At least one task is required to create in a program. (The created task is controlled by program file to be executed.) When a program file is executed by PLC CPU, set its execution type (e.g. scan or cyclic) by the program setting of the parameter.
Task	Task is an element to assemble multiple POU's and register them as a program file. At least one program in POU is required to register to a task. (Functions and function blocks cannot be registered to the task.)
Program block	Program is an element of the top level in a POU. Program can be edited using functions, function blocks and operators.
Function block	Function block can be edited using functions, function blocks and operators. To use a function block, it can be called from a program or another function block. Note that it cannot be called from a function.
Function	Function can be edited using functions and operators. To use a function, it can be called from a program, another function or a function block.
PLC message data	Defines PLC messages such as alarm messages and PLC switches. PLC messages can be used only in ladder diagram. PLC messages cannot be used only in ST language. To use a PLC message in the sequence program created in ST language, it must be written by using some text editor. Otherwise, use a PLC message created in ladder diagram.
Device comments	Comment for devices in sequence programs. There are two types: project-common "Global Device Comment" and program-specific "Local device comment". To change the settings, open [Tools] - [Options] window and select [Program Editor] - [All Editors] - [Device Comments].
Parameter	Set the use range of devices and order of sequence program execution, etc.
Global label	Label variable that becomes valid for all sequence programs when multiple sequence programs are create in a project.
Local label	Label variable that becomes valid only in each sequence program. This is one-on-one setting with an individual sequence program.

5.7.1.1 Symbolic Information

Symbolic information is data storing program configuration such as labels and FB. To read or write labels and FB to the CNC controller, read or write symbolic information.

For details on symbolic information, refer to "GX Works2 Operating Manual (Structured Project)".

5.7.2 Development Procedure

One of the standard procedures for developing structured projects is to create on GX Works2.

5.7.2.1 Developing New Simple Projects on GX Works2

Development procedure		Reference
(1)	Start GX Works2	-
(2)	Create a new project	5.5.5 Creating Project
(3)	Set connection with CNC controller	5.4.2.5 Setting Connection Destination
(4)	Set parameters ♦ Program setting of PLC parameters, the number of device points in CNC, and the number of device points in GX Works2 must be consistent.	5.5.8 Setting the Parameters
(5)	Configure Program ♦ Create and register program files, tasks and POU's (e.g. function blocks).	"GX Works2 Operating Manual (Structured Project)"
(6)	Set labels ♦ Set global labels and local label. ♦ Set the range for automatically assigned devices.	5.10 Creating Label "GX Works2 Operating Manual (Structured Project)"
(7)	Edit sequence program	Ladder Diagram "GX Works2 Operating Manual (Simple Project)" ST Language "GX Works2 Operating Manual (Structured Project)"
(8)	Write sequence programs and parameters into CNC RAM ♦ Sequence programs are written into temporary memory (CNC RAM).	5.5.8.6 Writing and Reading Parameters to CNC Controller 5.7.4 Writing the Sequence Program to the CNC Controller
(9)	Monitor (debug) sequence programs ♦ Return to (7) if any bug is found.	"GX Works2 Operating Manual (Simple Project)"
(10)	After debug is completed, write sequence programs to ROM in CNC. ♦ Sequence programs in temporary memory (CNC RAM) is transferred to CNC ROM.	5.7.6 Writing Sequence Programs to ROM in CNC

Note

- (1) If character string that cannot be used, "Label/data name contains invalid character string. Unable to use devices." is displayed when a project is compiled, reserved characters are used in the file name. Change the file name. Unable to use devices." reserved characters are used in the file name. Change the file name.
- (2) The timer limit setting must be fixed to "100ms" for low speed or "10.00ms" for high speed. It can be set on [PLC System] tab on the [Q Parameter Setting] setting screen displayed by selecting [Parameter] - [PC Parameter] of the project view. The CNC is not compatible with any other value described above for the timer limit.

5.7.3 Developing Sequence Programs

This section describes how to develop sequence programs in a structured project. There is no basic development procedure that is specific to Mitsubishi Electric CNCs. Refer to "GX Works2 Operating Manual (Structured Project)". This section provides information on CNC-specific restrictions.

5.7.3.1 CNC-Specific Restrictions

■ Restriction on use of ANB instruction and ORB instruction

The restriction is the same as that for simple project.

For details, refer to "Restriction on use of ANB instruction and ORB instruction" in "5.6.3.1 CNC-Specific Restrictions".

■ Restriction on MPS instruction use

The restriction is the same as that for simple project.

For details, refer to "Restriction on MPS instruction use" in "5.6.3.1 CNC-Specific Restrictions".

■ Cyclic interval of a task

When a task is activated in a cyclic interval, set "10ms" or "100ms" for one cycle. (For cyclic activation, [FALSE] must be selected for [Event] setting in [Attribute] option on [Details] tab of task property screen.)

When the value is not set to "10ms" or "100ms" as the example below, the set value is rounded to the unit of "10ms" or "100ms".

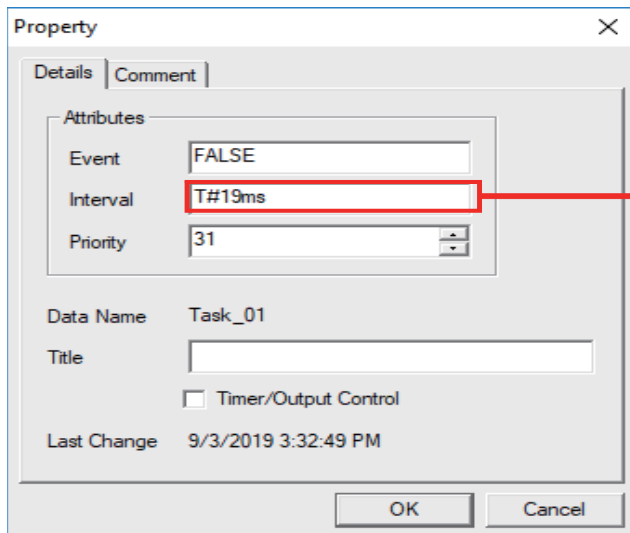

When "19ms" is set as shown in the figure, the value is rounded to "10ms" at the timing of compiling.

Class	Content
Task setting check	The value 19 of the time interval of Task is rounded to 10.0.

5.7.4 Writing the Sequence Program to the CNC Controller

This section describes how to write sequence programs in a structured projects from GX Works2 to the CNC controller (particularly restrictions and operation specific to this CNC).

Note

- (1) This operation writes data to the temporary storage in the CNC (RAM in CNC). Data in temporary storage (RAM in CNC) are not retained after power OFF. To retain data after power OFF, write sequence programs to the ROM in the CNC according to "5.7.6 Writing Sequence Programs to ROM in CNC".

5.7.4.1 Operation Procedure

- (1) Start the operation screen by the following operation on GX Works2.
[Online] -> [Write to PLC]
- (2) Select [Program Memory/Device Memory] in [Target Memory Setting] for [Symbolic Information] on the following screen. Select [Program Memory/Device Memory] in the target memory setting for PLC data. Select symbolic information and sequence program file to be written, and click [Execute]. Use [Remote Operation] under [Related Functions] to instruct the PLC to RUN or STOP.

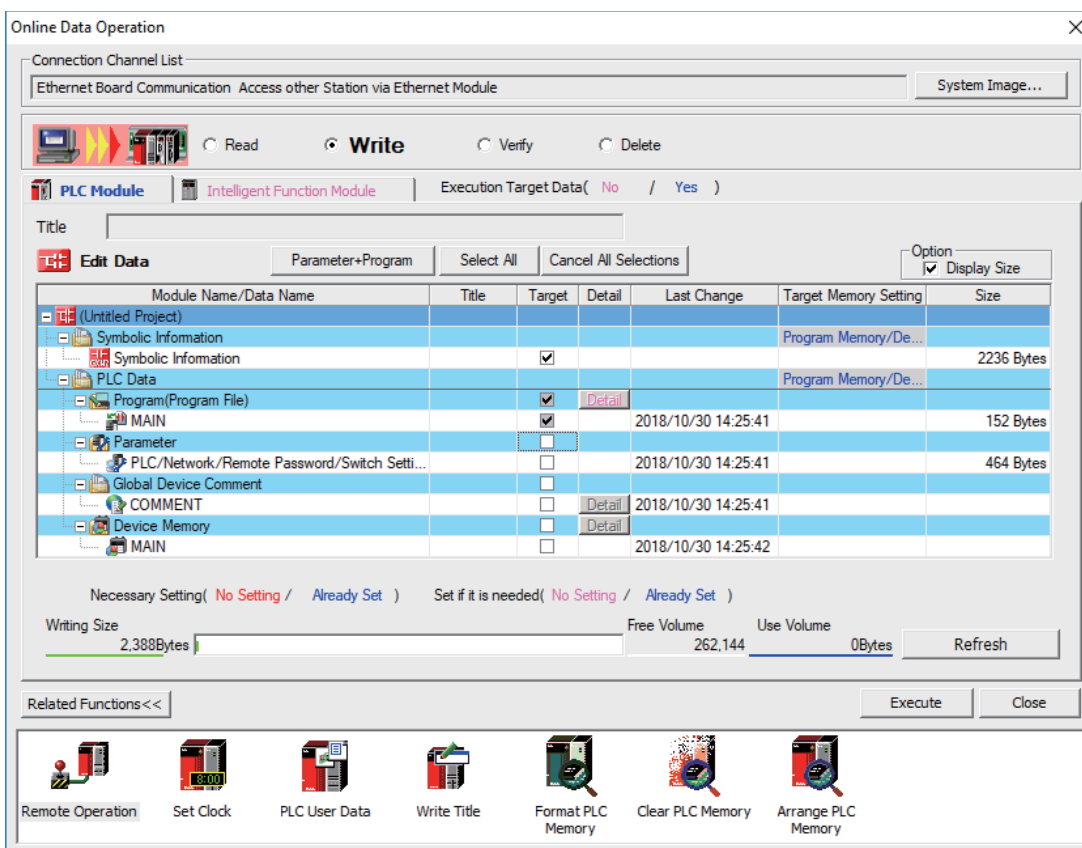

Note

- [Program Memory/Device Memory] is the only valid option for [Target Memory Setting].
- When the symbolic information is written to a CNC, labels, function blocks, etc. included in the sequence program are also written.

5.7.4.2 Writing Operation

When the writing of ladders to the CNC controller is executed on GX Works2, the CNC controller converts the ladders to ladder machine codes specific to CNC as they are written.

When devices and instruction formats that are not supported by the CNC controller are used, a conversion error is generated. Even if a conversion error is generated, writing is not stopped. Transfer up to the final step is completed by converting the instructions with error into NOP instruction (No operation instruction).

Note

(1) Ladders with an error cannot be run for safety reasons.

5.7.4.3 Operation and Check on Conversion Error

■ Operation on conversion error

The following dialog is displayed on the GX Works2 screen on conversion error.

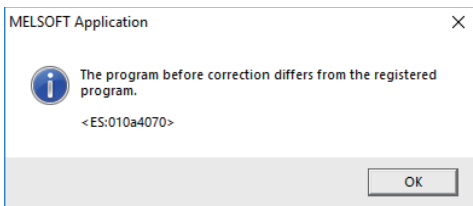

An attempt to run the PLC fails with an alarm on the CNC.

If a program file with a conversion error is displayed on the "Delete PLC Data" screen, the file name and title will change and be displayed as shown below.

ERRLD-XX ("XX" represents the error file number that is sequentially added from 0 in hexadecimal notation.)

ERRLD-00 < -- MAIN : Convert ERROR. (1) File name at error + Error No. (HEX)

(1) (2) (2) Title containing the name of source file

Module Name/Data Name	Title/Project Name	Target	Last Change	Target Memory Setting	Size
Q26UDHCPU				Program Memory/De...	
Symbolic Information				Program Memory/De...	
GX Works2(Structured Project)			2019/09/03 13:46:42		2444 Bytes
PLC Data				Program Memory/De...	
Program(Program File)					
ERRLD-00	<-- MAIN : Convert ERROR.		2019/09/04 11:21:50		2220 Bytes
Parameter					
PLC/Network/Remote Password/Switch Set...			2019/09/04 10:47:42		464 Bytes

⚠ CAUTION

Do not read to and use on GX Works2 the ladder files for which a conversion error is generated. Unintended data are included, and malfunction may result.

■ How to check conversion step with an error number

Error steps can be checked using PLC verify function.

For details on PLC verify function, refer to "5.7.7 Verifying the Sequence Programs".

Verify Source: Select transfer source ladder file on GX Works2

Verify Destination: Select ladder with an error file "ERRLD-00" in the CNC controller

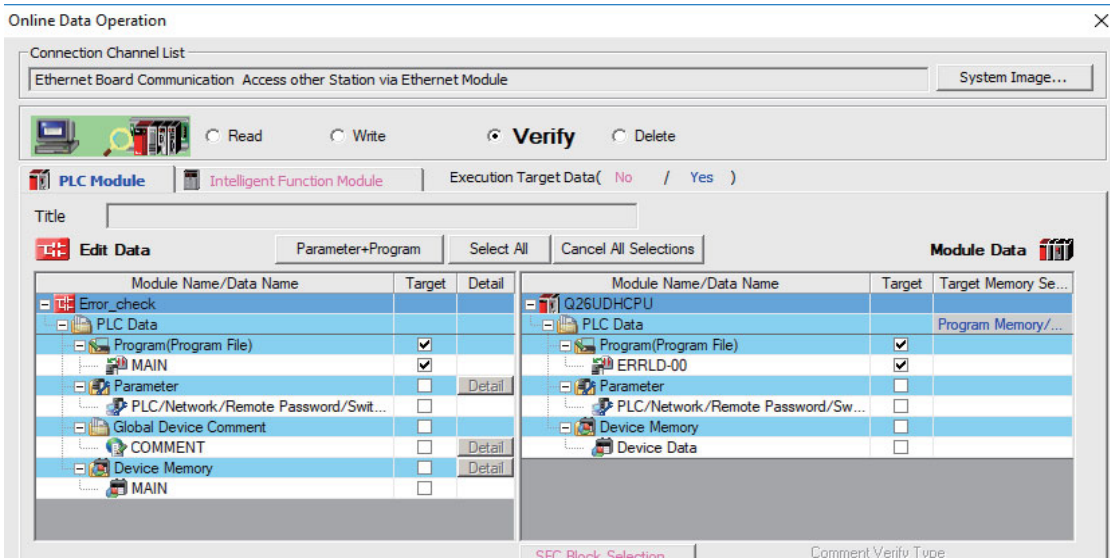

When PLC verification is executed, the verify result screen is displayed. When a file name is double-clicked, mismatched contents are displayed as shown in the example below. The NOP instructions on the CNC controller are the steps with conversion errors.

Double-click one of them to display and edit the corresponding part on the GX Works2 file.

"<Verify Source>" indicates the GX Works2 side, and "<Verify Destination>" the CNC controller side.

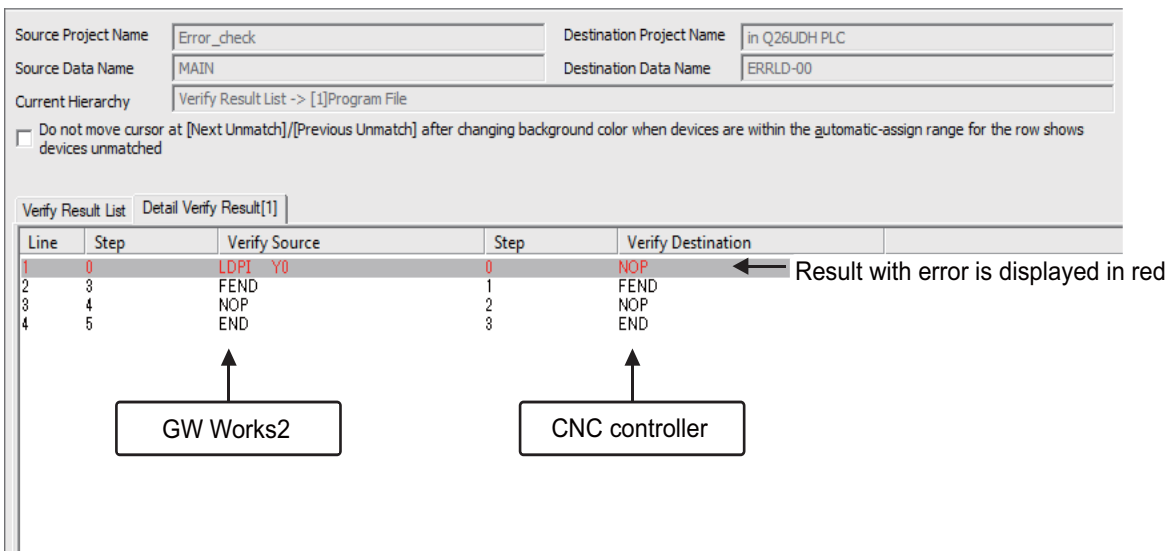

5.7.4.4 Other Operations and Checks on Error

■ Other errors

This section describes common errors that are generated when sequence programs are written.

Note that messages in displayed dialogs may not indicate the correct error status for CNC because they are for MELSEC PLC center. Status is displayed as the last 4 digits of the display number.

For details of other errors, refer to "5.13.1 List of Errors during GX Works2 Online Operation".

Status	Message	Cause	Remedy
4005 (*1)	Writing of data which exceeds the capacity of the PLC was attempted. Execute again within the capacity of the PLC.	The maximum number of steps that can be executed with NC has been exceeded.	Check the size of execution area. (Refer to "How to check size of area for execution" of this section.) Reduce the number of steps for the sequence program to be executed according to that value.
4010	Cannot write because the PLC is executing a RUN command. Stop the PLC, then execute again.	The PLC of the NC is running.	After stopping the PLC of the NC, start execution again.
4021	The applicable drive is not ready	The specified target memory does not exist or is not in a usable status.	Change the target memory.
4029	Insufficient file capacity. Execute again after deleting unnecessary files.	An attempt was made to write a file that exceeds the storage capacity.	Examine the file structure so that the data falls within the limited capacity.
4052	The file is write protected. Change the file attributes to enable writing to the file.	The specified target memory is a write-disabled device (CNC ROM).	Specify "Program memory/Device memory" as the target memory.
4065	A mismatch occurred between the PLC and peripheral parameters. Match the parameters between the PLC and peripherals.	There is a problem in the device setting value.	Set the number of device points. (Refer to "5.5.8 Setting the Parameters")
4070	The program before correction differs from the registered program.	A ladder instruction outside the specification is included.	Execute verify to identify the problematic instructions (Refer to "5.7.4.3 Operation and Check on Conversion Error")

How to check size of area for execution

When "error status (4005): Execution area size over" ((* in the error list described previously) is generated, check the size of the execution area as follows. For details on execution area, refer to "PLC Programming Manual".

When [Standard RAM] is selected as [Target Memory] for [PLC Data] on the "Delete PLC Data" screen, the file name and the title are changed and displayed as follows.

- (a) Target Memory Setting
- (b) The number of steps at execution when the title section is replaced.
The alphabet at the head of the number of steps indicates the state of parameter designation.
I: Initial; H: High speed; M: Medium speed; W: Wait
-: No parameters or parameters not stored
- (c) The total number of steps at execution. (Total of "Initial", "High speed", "Medium speed" and "Wait")
The denominator indicates the maximum size of the execution area.
When there is no parameter, the single program method is applied and "TOTAL" will not be displayed.

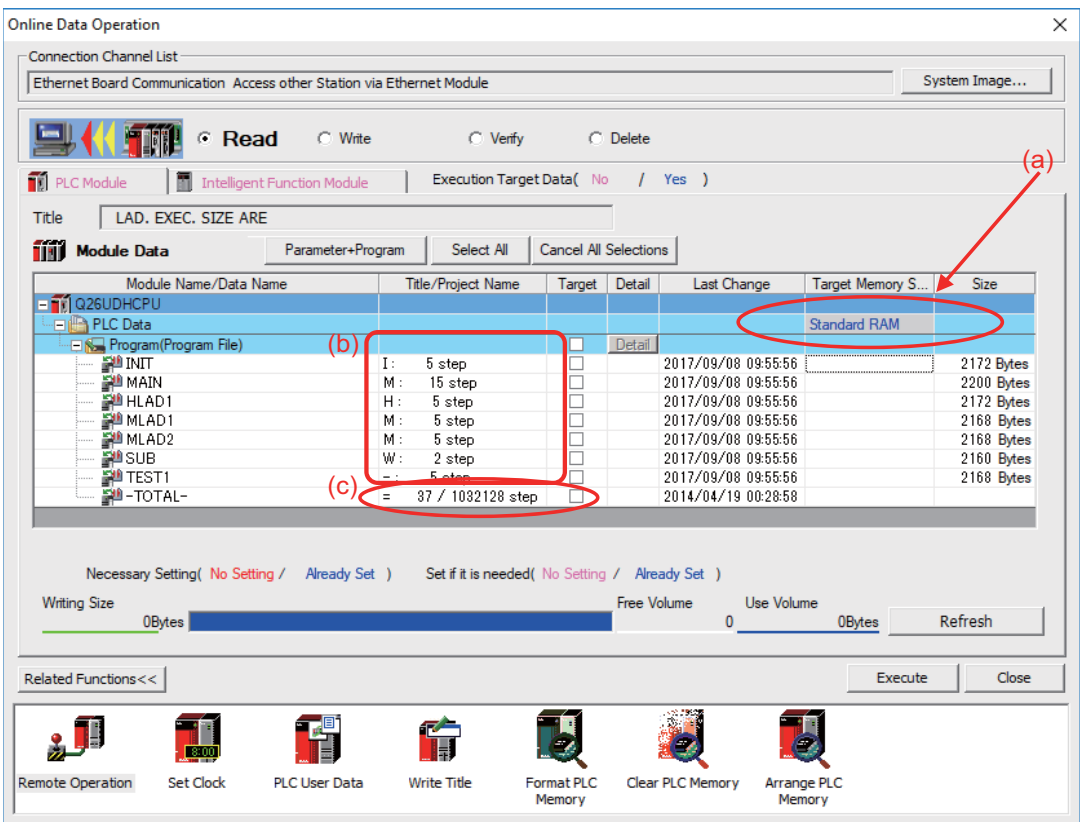

In the above screen example, adjust the size of the sequence program so that the total number of steps at execution (37) indicated in (c) is smaller than the denominator: the maximum size (1032128) of the execution area.

Note

- (1) Exercise caution not to delete files by mistake when checking the size of the execution area.

5.7.5 Reading Sequence Programs from CNC Controller

This section describes how to read GX Works2 sequence programs from the CNC controller.

5.7.5.1 Operation Procedure

- (1) Start the operation screen by the following operation on GX Works2.
[Online] -> [Read from PLC]
- (2) Select [Program Memory/Device Memory] in [Target Memory Setting] for [Symbolic Information] on the following screen. Select "GX Works2 (Structured project)", and click [Execute].

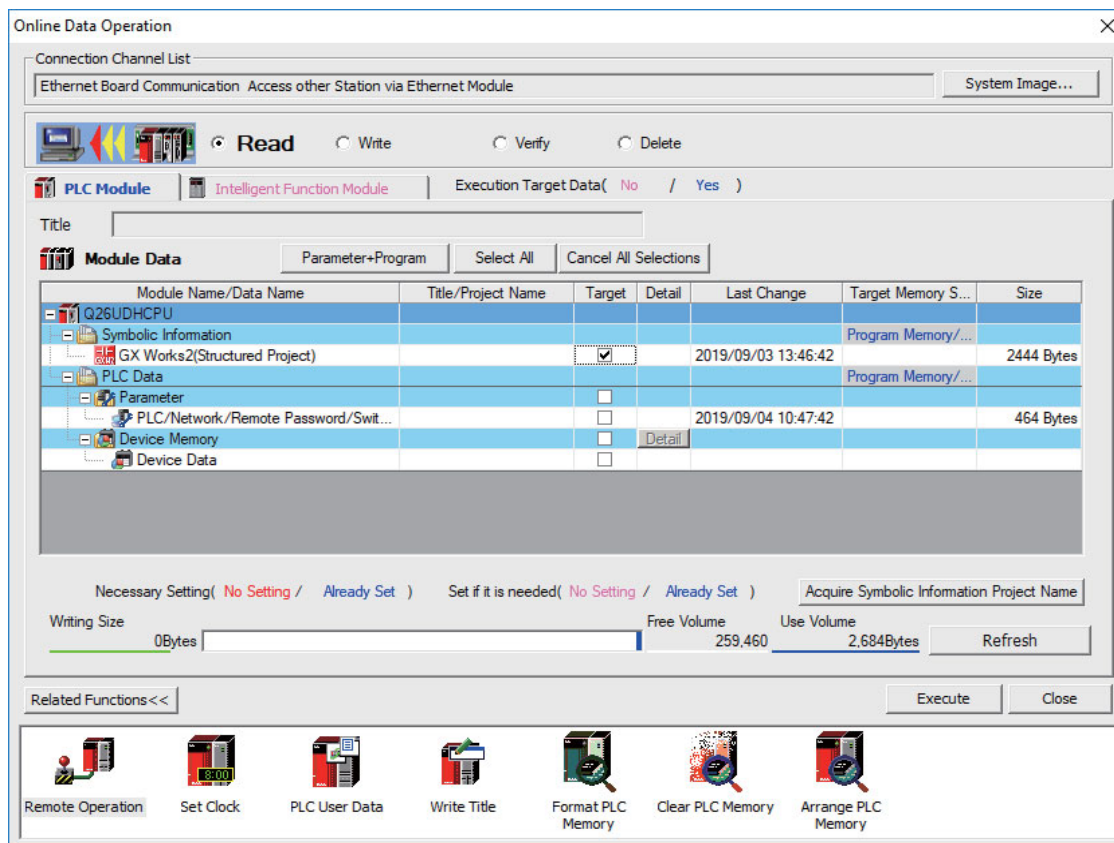

Note

- [Program Memory/Device Memory] is the only valid option for [Target Memory Setting].
- Click [Refresh] before reading symbolic information.
- For details on read parameters before reading symbolic information, refer to "5.5.8.6 Writing and Reading Parameters to CNC Controller".
- When symbolic information is read, labels and FB are also read as well as sequence programs.

(3) Select [Yes] when the following dialog is displayed. Sequence programs and label data are read.

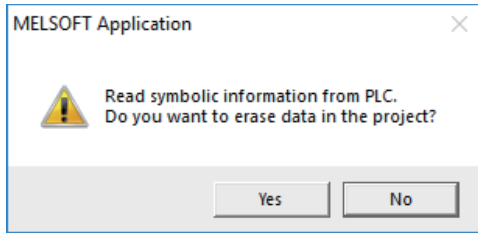

Note

- When [Yes] is clicked in the above dialog, the sequence program files, labels and FB on GX Works2, are overwritten and deleted. Check thoroughly before executing. (No prompt for overwrite confirmation is displayed even when there is a file of the same name.)

The "Read from PLC" screen can also be used as file list function of the CNC controller. The date and time of update and the size of each file is displayed on the right side of the file name.

5.7.6 Writing Sequence Programs to ROM in CNC

Sequence programs transferred from GX Works2 and built-in PLC (built-in edit function) to the CNC controller are stored in temporary storage. Data in temporary storage are erased at power OFF. (The sequence programs stored in the ROM in the CNC is enabled by powering ON the CNC controller again.)

To retain data after the CNC is powered ON again, transfer the sequence programs in temporary storage to the ROM in the CNC according to the following procedure.

This section describes how to transfer sequence programs in the temporary storage the CNC controller to the ROM in the CNC on GX Works2.

For the user safety sequence, refer to "M800/M80 Series Smart safety observation Specification manual".

Note

- (1) When the sequence programs in temporary storage (RAM in CNC) are updated, but not written to the ROM in the CNC, "ROM-Write incomplete" error is generated.

5.7.6.1 Operation Procedure

- (1) Start the operation screen by the following operation on GX Works2.

[Online] -> [Export to ROM Format]

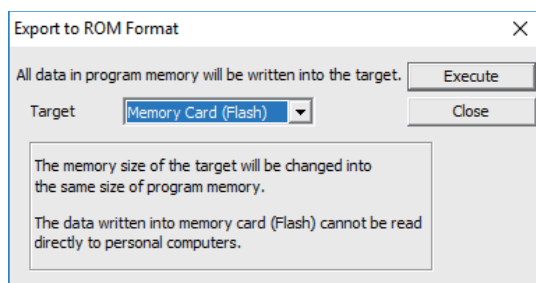

Note

- Only [Memory card (Flash)] is valid as [Target].

- (2) Click [Execute] to display the following dialog, and click [Yes].

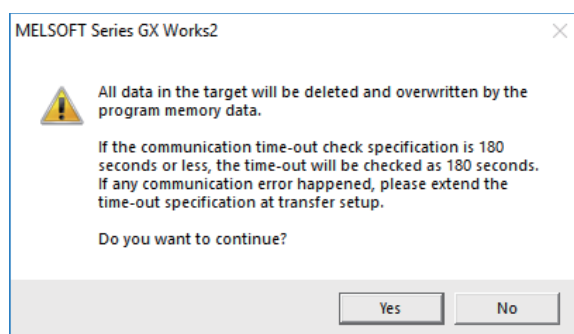

Note

- When [Yes] is clicked in the above dialog, sequence program files on the ROM in the CNC the CNC controller are over-write and deleted. This should be done with extreme caution.

- (3) The operation is completed when the following dialog appears. Click [OK].

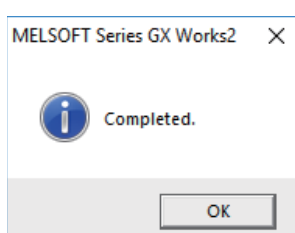

5.7.7 Verifying the Sequence Programs

This section describes how to verify sequence programs between the CNC controller and GX Works2.

5.7.7.1 Operation Procedure

(1) Start the operation screen by the following operation on GX Works2.

[Online] -> [Verify with PLC]

(2) Select the sequence program file to verify on the following screen, and click [Execute].

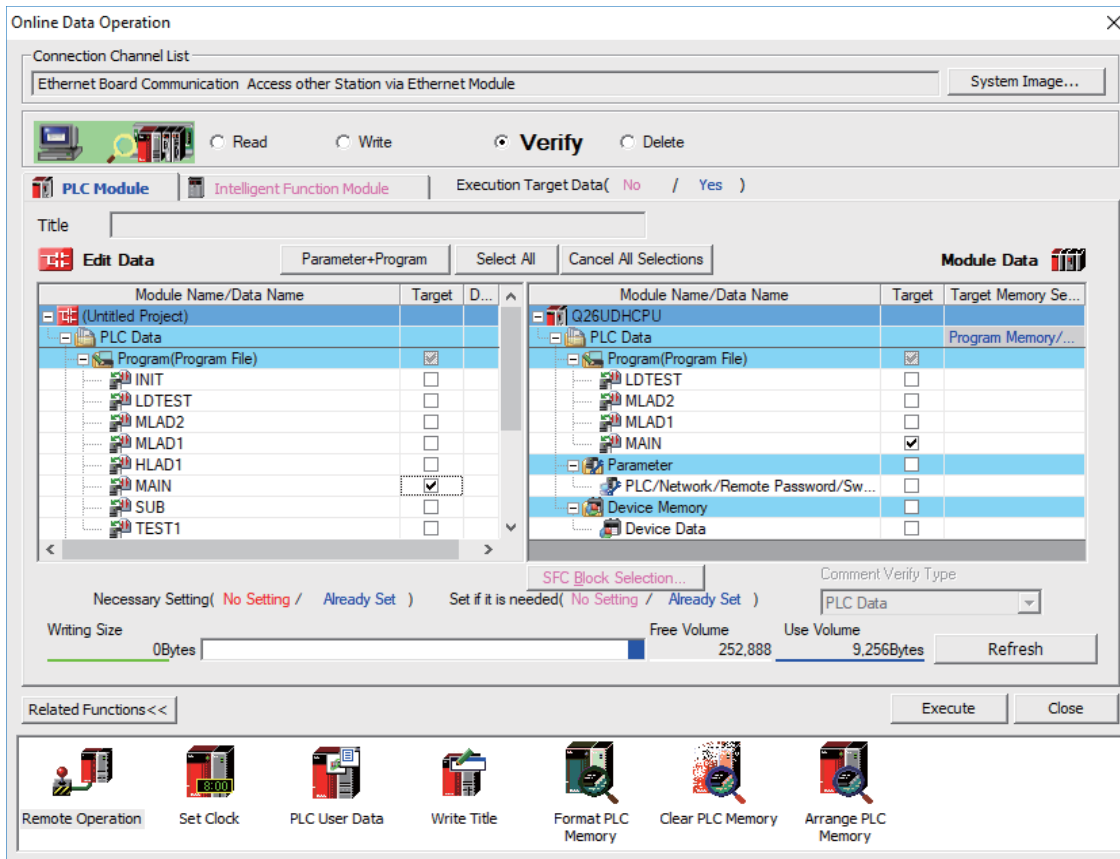

Note

- The memory that has the file to be verified is valid as [Target Memory Setting].

When verification finishes, the verify result screen is displayed. Double-click a file name to display on the screen the detailed result as shown below. Unlike GX Developer, matched places are also displayed on GX Works2. Mismatched contents are displayed in red. Click [Find/Replace] - [Next Unmatch] and [Find/Replace] - [Previous Unmatch] to find previous and next mismatch places. Double-click mismatched contents to display and edit the corresponding parts in the GX Works2 file.

Source Project Name	(Untitled Project)	Destination Project Name	in Q26UDH PLC
Source Data Name	MAIN	Destination Data Name	MAIN
Current Hierarchy	Verify Result List -> [1]Program File		

Line	Step	Verify Source	Step	Verify Destination
1	0	LD M0	0	LD M0
2	1	OUT Y2	1	OUT Y2
3	2	LD M2	2	LD M2
4	3	OUT Y3	3	OUT Y3
5	4	LD M3	4	LD M3
6	5	MOV K100 D0	5	MOV K10 D0
7	7	LD D0.1	7	LD D0.1
8	8	AND D0.0	8	AND D0.0
9	9	OUT Y50	9	OUT Y5
10	10	END	10	END

Note

- (1) The verification result is displayed by mnemonic codes as shown in the figure above, regardless of the setting of the programming language (ladder diagram or ST language).

5.7.8 Monitoring Sequence Programs

The monitoring of sequence programs has no operation specific to Mitsubishi Electric CNC. For details on operating procedure, refer to "GX Works2 Operating Manual (Common)". For details on functions that can be used, refer to "5.3.5 Function Support Status (Online)". This section provides the overview of the operating procedure and cautions.

5.7.8.1 Operation Procedure

Start monitoring by the following operation on GX Works2.

- (1) Display sequence programs to be monitored, and move to the ladder to be monitored.
- (2) Start monitoring by either of the following operations.
Select [Online] - [Monitor] - [Monitor Mode] or press "F3" key.
- (3) Stop monitoring by either of the following operations.
Select [Online] - [Monitor] - [Monitor Mode] or press "Alt" and "F3" keys simultaneously.

Note

- (1) When the sequence programs running on the CNC controller and the sequence programs displayed on GX Works2 are different, errors are not generated even if monitoring is executed, and monitoring appears to continue normally.
Before executing monitoring, ensure that sequence programs in the CNC controller and GX Works2 are the same.

5.8 PLC Message Development

This section describes how to develop PLC messages such as alarm messages, operator messages, and PLC switches as PLC-related data.

Refer to "PLC Programming Manual" on how to display a PLC message on HMI screen.

PLC messages can only be created using ladder diagram. It cannot be created in ST language. To use PLC messages in the sequence program created in ST language, it must be written by using some text editor. Otherwise, use a PLC message created in ladder diagram.

For the user safety sequence, PLC message function cannot be used.

5.8.1 Adding PLC Messages

There are two ways to add PLC messages as shown below.

[Writing PLC messages on the standard screen]

	Development procedure	Description	Reference
(1)	Create PLC messages on Text Editor	Develop PLC messages.	5.8.2 Developing on Standard Screen
(2)	Write PLC messages	Transfer PLC messages to CNC controller from HMI screen.	

[Writing PLC messages on GX Works2]

	Development procedure	Description	Reference
(1)	Create PLC messages on Text Editor or GX Works2	Develop PLC messages.	5.8.6 Development Procedure Using GX Works2
(2)	Write PLC messages	Transfer PLC messages to built-in ROM using GX Works2	5.8.10 Writing CNC Controller on GX Works2

PLC messages are written directly to built-in ROM when GX Works2 is used. Writing to ROM is not required.

Note

- (1) PLC messages are written as different types of files by either way described above. When a PLC message is in both files, the one written on the standard screen is used first.

5.8.2 Developing on Standard Screen

This section describes how to develop message data.

(1) Create

Create message data using a generally available text editor. The written format and how message data are described follow.

(2) Write

Write to the CNC controller using the input/output screen of the standard screen.

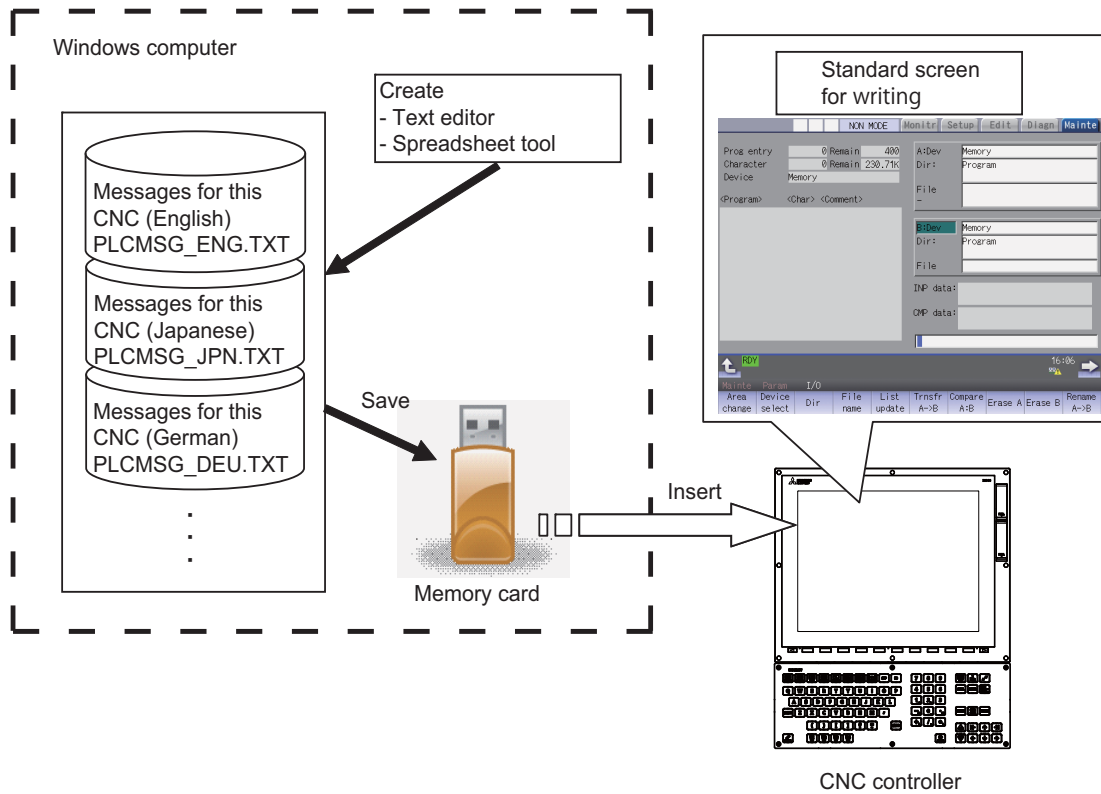

5.8.3 Writing Message Data on the Standard Screen

Message data can be written as text data using generally available text editor and commercial spreadsheet software. Message files are described with one-byte alphanumeric characters or multi-byte characters according to the language. The format of message data are different between GX Works2 and GX Developer.

5.8.3.1 Description format

Message data is described in the description format shown below.

Use commas (,) as the separator between descriptions.

The description format cannot be omitted. Even if the message text is blank, comma (,) and line feed code are required.

Message classification	Description format				
Alarm message	A ,	Index No. ,	Data register No.,	Message character string	Line feed code
Operator message	O ,	Index No. ,	Data register No.,	Message character string	Line feed code
PLC switch	P ,	Switch No.,	Message character string	Line feed code	
Comment message	M ,	device,	Device No.,	Message character string	Line feed code
Macro alarm message	M ,	Index No. ,	Alarm No.,	Message character string	Line feed code

Message classification code : A one-byte alphabetic character expressing each message classification

Index No. : One-byte numeric character

Data register No. : One-byte numeric character

Switch No. : One-byte numeric character

Device : One-byte numeric character (1: Spindle/standby name)

Device No. : One-byte numeric character (Always "0" if the device is the spindle/standby name)

Alarm No. : One-byte numeric character

Message character string : One-byte numeric character, or multi-byte character

Line feed code : (CR/LF) or (LF)

Note

(1) Semicolons, commas, spaces, and tabs can be used. Note that the tab at the head of the message character string is ignored.

For details on the maximum number of characters in a message, refer to "5.8.3.4 Precautions".

5.8.3.2 Description Method

Message data is described as text data in the written format shown below.

The applicable character code is different depending on the target language. Refer to the section "File name rule" for details.

■ Example for the description of alarm message, operator message, PLC switch and comment

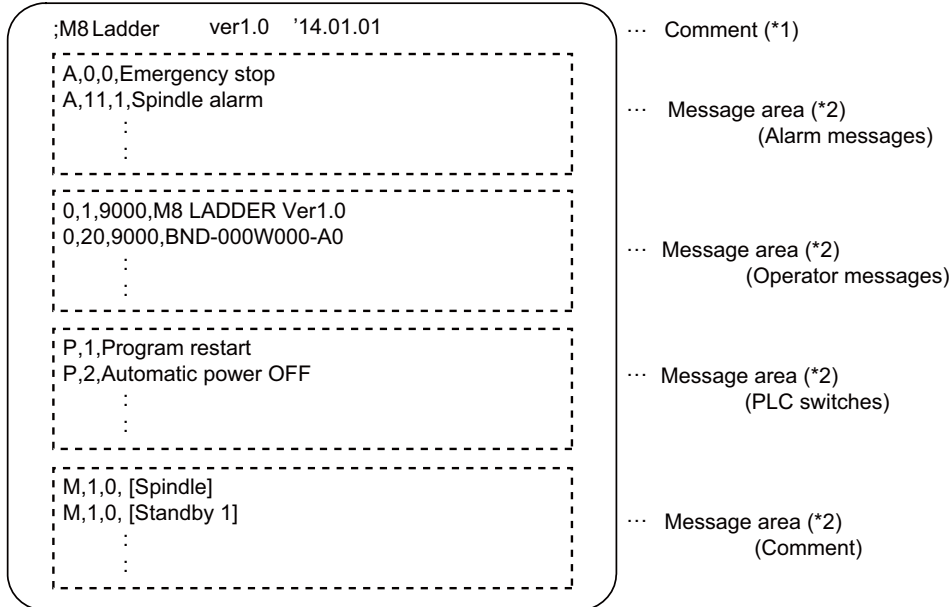

(*1) Comment

A line begins with a semicolon (;) is regarded as a comment.

```
; comment character string [LF]
```

(*2) Message area

Messages of the same type are describe together. When the same elements (e.g. index No.) are included, the latter description is enabled.

■ Example for the description of macro alarm message

```

M,0,1,CALL #PROGRAMMER #TEL590
M,1,2,CALL #PROGRAMMER #TEL560
M,9,10,CALL #PROGRAMMER #TEL550
:
:
M,511,9999,CALL #PROGRAMMER #TEL520

```

- ♦ When there are duplicate index Nos. or alarm Nos., the one appears later on the file is enabled.
- ♦ The index Nos. need not be in sequential order, if they are within the designated range. Also, there is no restriction for the description order (in ascending or descending order).
- ♦ When an alarm message is consist of 32 characters or more, the 32nd or later character is not displayed. If the 31st character is 2-byte character, the 31st character is not displayed.
- ♦ A blank character (a space character) can be used for the alarm message string.
- ♦ A line matches any of the following conditions is regarded as invalid data.
 - The classification code is set to other than "M".
 - Index No. is not in the range from 0 to 511.
 - Alarm No. is not in the range from 1 to 9999.
 - Other incorrect format is described in the file.
 - Description for one line is exceeded 128 characters.

5.8.3.3 File Name Rule

The following table shows the names of files written to the CNC controller and the character codes used to describe messages.

The CNC controller switches the file for PLC message display in accordance with the setting of parameter for the display language ("#1043 lang").

		File name		
#1043 lang		Alarm message, operator message, PLC switch or comment	Macro alarm message	Character code
0	English	PLCMSG_ENG.TXT	MCRMSG_ENG.TXT	Windows-1252
1	Japanese	PLCMSG_JPN.TXT	MCRMSG_JPN.TXT	Shift-JIS
11	German	PLCMSG_DEU.TXT	MCRMSG_DEU.TXT	Windows-1252
12	French	PLCMSG_FRA.TXT	MCRMSG_FRA.TXT	Windows-1252
13	Italian	PLCMSG_ITA.TXT	MCRMSG_ITA.TXT	Windows-1252
14	Spanish	PLCMSG_SPA.TXT	MCRMSG_SPA.TXT	Windows-1252
15	Chinese (traditional)	PLCMSG_CHI2.TXT	MCRMSG_CHI2.TXT	Big5
16	Korean (Hangeul)	PLCMSG_KOR.TXT	MCRMSG_KOR.TXT	KS C 5601-1987
17	Portuguese	PLCMSG_POR.TXT	MCRMSG_POR.TXT	Windows-1252
18	Dutch	PLCMSG_DUT.TXT	MCRMSG_DUT.TXT	Windows-1252
19	Swedish	PLCMSG_SWE.TXT	MCRMSG_SWE.TXT	Windows-1252
20	Hungarian	PLCMSG_HUN.TXT	MCRMSG_HUN.TXT	Windows-1250
21	Polish	PLCMSG_POL.TXT	MCRMSG_POL.TXT	Windows-1250
22	Chinese (simplified)	PLCMSG_CHI1.TXT	MCRMSG_CHI1.TXT	GB2312
23	Russian	PLCMSG_RUS.TXT	MCRMSG_RUS.TXT	Windows-1251
24	Turkish	PLCMSG_TUR.TXT	MCRMSG_TUR.TXT	CP1254
25	Czech	PLCMSG_CZE.TXT	MCRMSG_CZE.TXT	Windows-1250
31	Indonesian	PLCMSG_IND.TXT	MCRMSG_IND.TXT	Windows-1252
32	Vietnamese	PLCMSG_VIE.TXT	MCRMSG_VIE.TXT	Windows-1258

5.8.3.4 Precautions

(1) Priority of message files in each language

When PLC message files for display languages are not in the CNC controller, English message files are used.

(2) Maximum values of message data

This table lists the maximum values of message that can be written.

Message type	Maximum message length (number of characters)	Maximum number of messages
Alarm messages	46 bytes	1024
Operator messages	60 bytes	512
PLC switch	14 bytes	96
Comment	60 bytes	5
Macro alarm message	31 bytes	512

Even though a message data exceeds the maximum message length, no error occurs. The excessive characters are not displayed.

Even though the total number of messages exceeds the maximum number, no error occurs. The excessive messages are not displayed.

A two-byte character is handled as two characters (2 bytes).

(3) Macro alarm messages are displayed with the following priority.

Priority	Details
(1)	Displays the macro alarm message of corresponding alarm No. which is described in the macro alarm message file of the display language. However, the macro alarm message of the second priority is displayed in the following cases: - No macro alarm messages file for the display language - No corresponding alarm No. in the macro alarm message file
(2)	Displays the macro alarm message of corresponding alarm No. which is described in the macro alarm message file of the default language (English). However, the macro alarm message of the third priority is displayed in the following cases: - No macro alarm messages file for English - No corresponding alarm No. in English macro alarm message file
(3)	Displays the macro alarm message described on a machining program.

5.8.4 Writing Message to CNC Controller on Standard Screen

The following operation procedure shows how to write messages to the CNC controller from the standard screen.

For details on the operation on the input/output screen, refer to the instruction manual of the CNC controller.

File names and directory names of PLC messages differ depending on by whom they are used (MTB or users).

PLC messages for users are displayed when "E/U mode" is enabled.

For details on the "E/U mode", refer to "9.1 Enhanced PLC Security Mode".

5.8.4.1 Operation Procedure

- (1) Press [I/O] menu on the maintenance screen.

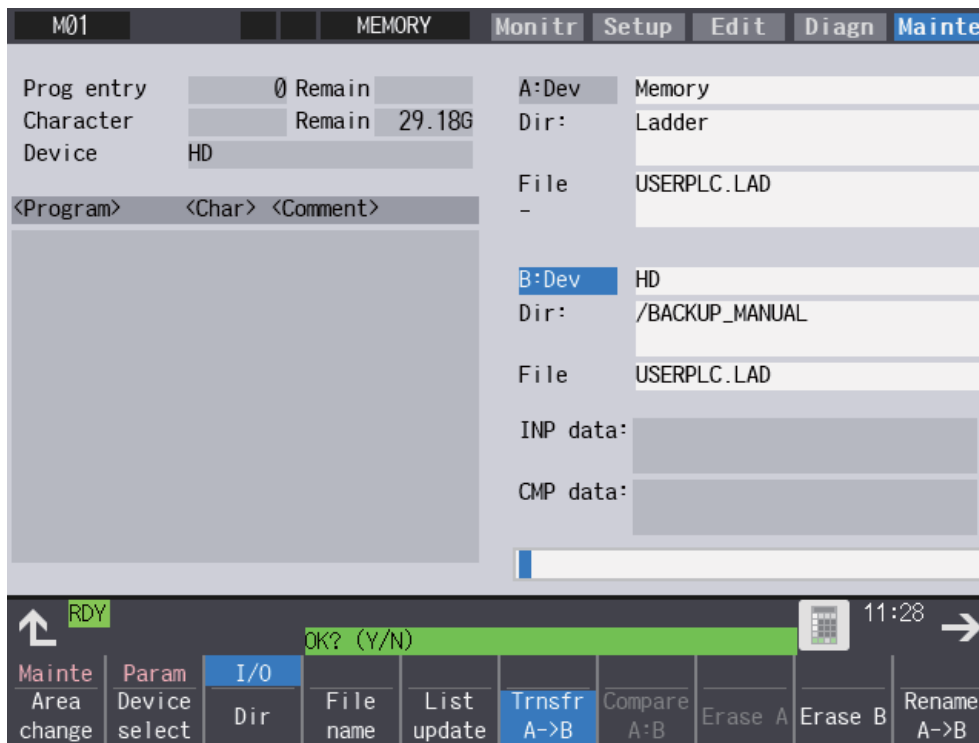

(2) Specify the source file to be transferred, and set the device name, directory and file name of the destination as follows.

- Display example of a PLC message file for MTB

A:Dev	M-Card	
Dir:	/	
File	PLCMMSG_*.TXT	Multiple files can be specified with wildcard (*).
-		
B:Dev	Memory	
Dir:	/PLCMMSG	Specify the PLC message directory.
File		Leave this field blank so that the source file names can be set.

- Display example of a PLC message file for users

A:Dev	M-Card	
Dir:	/	
File	PLCUMSG_*.TXT	Multiple files can be specified with wildcard (*).
-		
B:Dev	Memory	
Dir:	/PLCUMSG	Specify the PLC message directory.
File		Leave this field blank so that the source file names can be set.

(3) Press the menu key [Tnsfr A->B] to start file transfer.

5.8.5 Reading out from CNC Controller on Standard Screen

5.8.5.1 Operation Procedure

- (1) Press [I/O] menu on the maintenance screen.
- (2) Set the device name, directory and file name of the source as follows. Specify the output file in the destination field.

- Display example of a PLC message file for MTB

A:Dev	Memory
Dir:	/PLCMMSG
File	PLCMMSG_*.TXT
-	

- Display example of a PLC message file for users

A:Dev	Memory
Dir:	/PLCUMSG
File	PLCUMSG_*.TXT
-	

- (3) Press the menu key [Trnsfr A->B] to start file transfer.

5.8.6 Development Procedure Using GX Works2

There are two types of development procedure using GX Works2 as follows.

- ♦ Converting into GX Works2 data using a generally available text editor and spreadsheet.
(When managing the large amount of message data using a commercial tool)
- ♦ Input messages directly on GX Works2.
(When adding and correcting the small amount of message data)

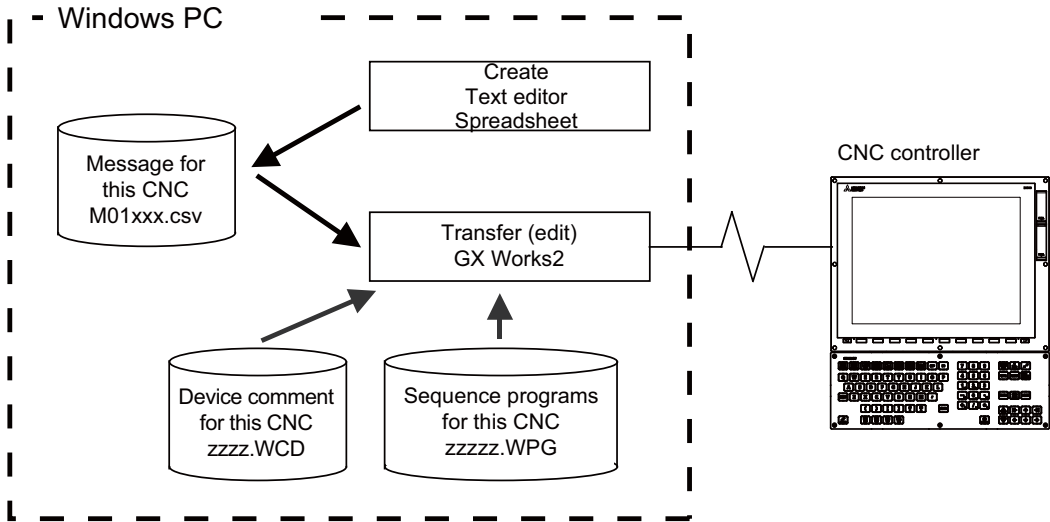

Note

- (1) In GX Works2, only CSV files can be read. Unlike GX Developer, TXT files cannot be read. CSV files of GX Works2 projects with label settings cannot be read. Thus, PLC message can only be developed by inputting messages directly from GX Works2.

5.8.6.1 Development Using Text Editor

- (1) Create
Create message data using a generally available text editor. The written format and how message data are described follow.
- (2) Transfer
In GX Works2, message data is treated as line statements of sequence programs, and can be edited. Like sequence programs, message data is transferred from GX Works2 to the CNC controller.

5.8.6.2 Inputting Messages Directly from GX Works2

- (1) Create
Describe message data directly on GX Works2. In GX Works2, message data is treated as line statements of sequence programs. The written format and how message data are described follow.
- (2) Transfer
Like sequence programs, message data is transferred from GX Works2 to the CNC controller.

5.8.7 Writing Message Data Using GX Works2

Aside from being directly input on GX Works2, message data can be described as text data on generally available text editor and commercial spreadsheet software. Create text data with Unicode (with BOM) character code, and use ".csv" as the extension.

5.8.7.1 Written Form

Message data is described in the written formats shown below.

The description format cannot be omitted. Even when a message text is blank, tab (^), comma (,), and [CR+LF] are needed to be written.

Message type	Description format				
Alarm message	^ A ,	Index No. ,	Data register No.,	Message character string	Line feed code
Operator message	^ O ,	Index No. ,	Data register No.,	Message character string	Line feed code
PLC switch	^ P ,	Switch No.,	Message character string	Line feed code	
Comment message	^ M ,	device,	Device No.,	Message character string	Line feed code

Message classification : A one-byte alphabetic character expressing each message classification code

Index No. : One-byte numeric character (between 0 and the maximum number of messages -1)

Data register No. : One-byte numeric character

Switch No. : One-byte numeric character (between 0 and the maximum number of messages -1)

Device : One-byte numeric character (1 or 2)

Device No. : One-byte numeric character(0 ~ 10)

Message character string : One-byte alphanumeric (character), shift JIS the first level character, the number of characters for the maximum message length.
Semicolons, commas, spaces, and tabs can be used. The tab at the top of a message text is ignored.

Tab (^) : Message data identification code. Add one at the top of message data.

Comma (,) : Delimiter of description elements
(Use only comma to make message text is blank)

Line feed code : (CR/LF)

Backslash (\) : Continue to next line.
When the end of a description is a backslash, continue to the top character of the next line.

5.8.7.2 How Message Data are Described

Message data is described as text data in the written format shown below.

<pre>"PLC_msg_wk" "PLC information:" "QCPU(Q mode) Q26UDH" "Step No. " "statement" "instruction" ^ ^ NOPLF ^ A,0,0,Emergency stop ^ A,11,1,Spindle alarm ^ ^ NOPLF ^ ^ ^ ^ NOPLF ^ ^ ^ ^ NOPLF ^ ^ ^ 0,1,9000,MELDAS 600 LADDER Ver1.0 ^ 0,20,9000,BND-400W000-A0 ^ ^ ^ ^ NOPLF ^ P,1,Program restart ^ P,2, Auto power OFF ^ ^ ^ ^ NOPLF ^ M,1,0,[Spindle] ^ M,1,0,[Wait 1] ^ ^ ^ ^ END</pre>	<p>... Header (The contents in the first lines are ignored when read to GX Works2. Input comments or leave them blank)</p> <p>... Message (Alarm message)</p> <p>... Page break code (Two tabs at the top)</p> <p>... Message (Operator message)</p> <p>... Message (PLC switch)</p> <p>... Message (Comment)</p> <p>... End code</p>
--	---

[Header]

The first three lines of the file are skipped when read to GX Works2.

[Message]

Messages of the same type are describe together. No order is set for describing within messages. If there are more than one description with the same element (index number, etc.), the last description is enabled.

[Page break code]

A page break code is described at one or more places approximately every 15 lines in the setting area and message area. The message data may skip if there is no page break code.

[End code]

Describe the end code at the end of a description. The description after end code is ignored. If there is no end code, an error occurs.

[Others description]

When the number of the tabs (^) at the top of the line is wrong, an error occurs. If the format of a description does not following the above, an error occurs. For details on the CSV file formats that can be read to GX Works2, refer to "GX Works2 Operating Manual (Simple Project)".

5.8.7.3 Precautions

This subsection describes the number of characters, the considerations on the number, handling of the information outside the settings and of the information outside the formats.

(1) Maximum values of message data

This table lists the maximum values of message that can be written.

Message type	Maximum message length (number of characters)	Maximum number of messages
Alarm messages	46 bytes	1024
Operator messages	60 bytes	512
PLC switch	14 bytes	96
Comment	60 bytes	100

Even though a message data exceeds the maximum message length, no error occurs. The excessive characters are not displayed.

When the maximum number of messages is exceeded: an error occurs when written.

Note

- A two-byte data in a message text is counted as 2 characters.

(2) When message cannot be described on one line

In GX Works2, up to 64 characters can be input as line statement in one line. Since this includes information other than message texts (e.g. message type code, index number, data register number), a message text consisting of 60 characters cannot be described in one line.

By dividing a line into two using backslash (\) as the last character of the line, the description of 60 characters become possible.

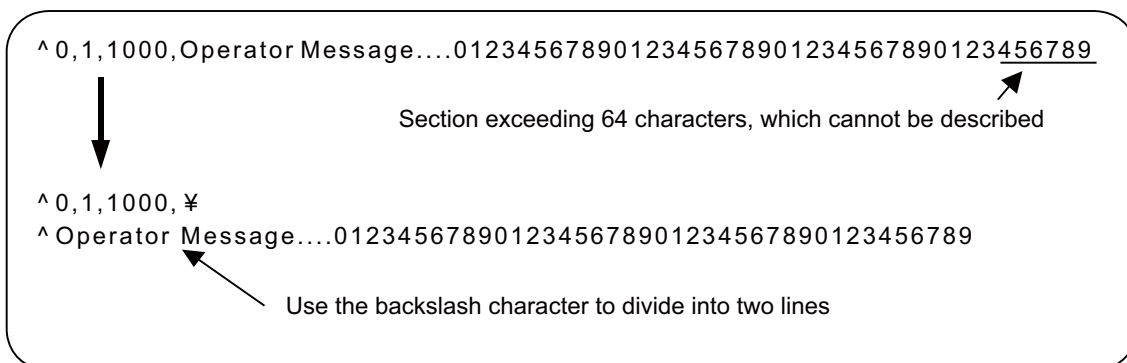

Note

- If the first character of the second line is an asterisk (*) when a line is divided into two, 60 characters cannot be described.

In this case, use another character like space instead.

(3) When created multiple message data have the same index No. or switch No.

When multiple message data include the same index No. or switch No. in a message file, the message data closest to the END instruction is displayed.

(4) When dealing with multi-language message

When the language used to describe message data is different from the region setting on Windows, characters will corrupt when written to the CNC, and cannot be read properly by a built-in edit function. To avoid this issue, change the region setting on Windows to the one appropriate for the language used to describe message data, before reading message data in the CSV format to GX Works2. Refer to "5.17.3 Multi-language Data" for details.

(5) Differences from message data for GX Developer

The format of message data used in GX Works2 is different from that used to write to GX Developer. GX Works2 cannot read message data created for GX Developer. For information on how to enable GX Works2 to read message data for GX Developer, refer to "5.8.12 How to Use on GX Works2 Message Data for GX Developer".

5.8.8 Reading Message Data on GX Works2

This section describes how to read on GX Works2 message data written with a text editor or other tools.

5.8.8.1 Reading to GX Works2

(1) Open the following screen by the following operation in the navigation window on GX Works2.

[Project] -> [POU] -> right-click [Program] -> [Read from CSV File]

(2) Select a desired message data file (M01_msg.csv) on the following screen, and click [Open].

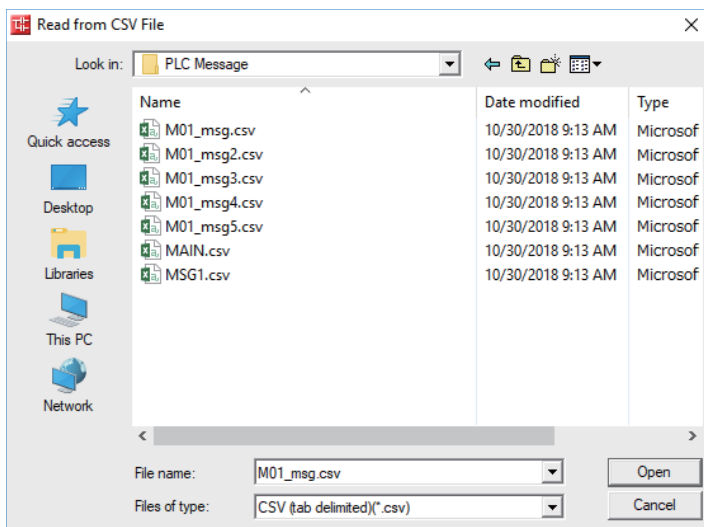

5.8.8.2 Precautions

Read from project with labels

Since CSV files cannot be read when a simple project (with labels) is selected, message data cannot be read. When reading message data to a project with labels, follow the procedure below.

- (1) Create a project as a simple projects (without labels).
- (2) Read message data to the project in (1).
- (3) Change the project in (2) to a simple projects (with labels) using [Project] -> [Change Project Type] function.
- (4) Copy the message data of the project in (3) to the project in which the data is to be stored.

5.8.9 Inputting and Editing on GX Works2

Message data in GX Works2 is treated as "integrated line statement" of sequence programs. "Integrated line statements" are interline comments that help understanding of sequence programs. Those which are transferred to a controller along with sequence programs are called "integrated".

Line statement can be displayed and edited on the "Program Editor" screen.

5.8.9.1 Displaying Line Statements

■ Display programs

Display the "Program Editor" screen from the navigation window of GX Works2 by the following operation.

The normal ladder screen is displayed first.

[Project] -> [POU] -> [Program] -> Double-click [program name to display]

■ Display message data

Display message data that is integrated line statement by the following operation.

[View] -> [Statement]

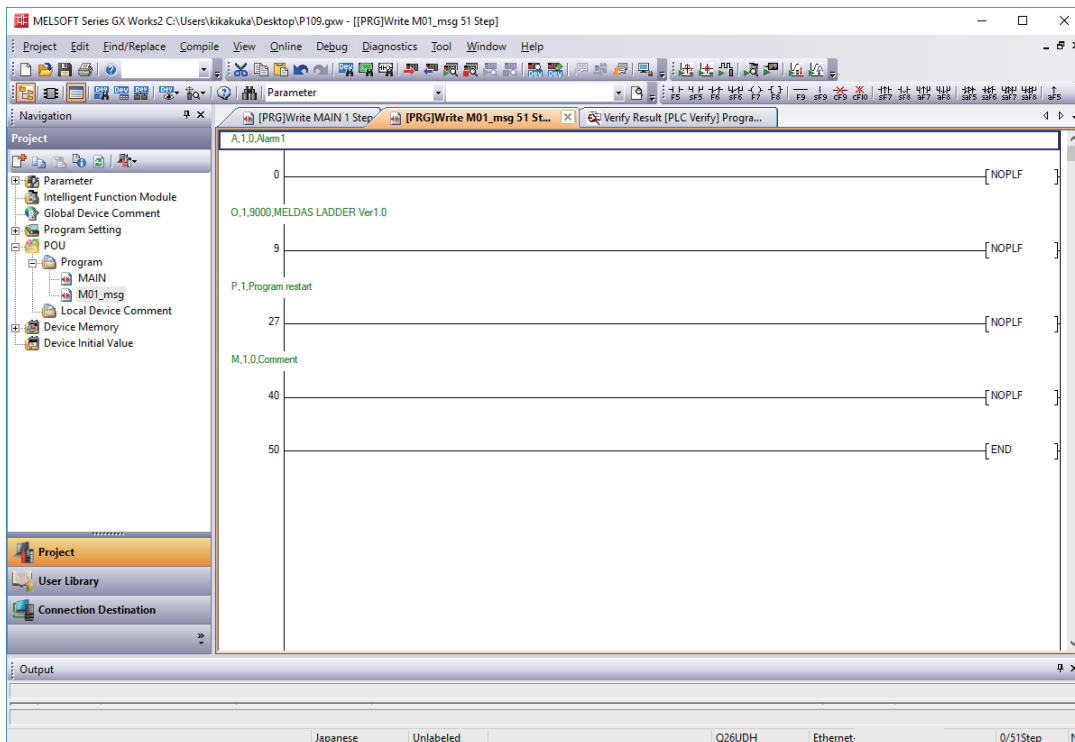

5.8.9.2 Editing Integrated Line Statement

■ Ladder display

Double-click the line statement to edit on the ladder display screen displaying the integrated line statements to display the following dialog.

Edit on the dialog, and click [OK] or input [Enter].

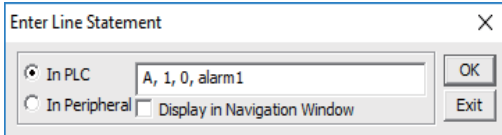

■ Inputting new message data

[Display new edit screen]

Display "New Data" dialog on the navigation window by the following operation, and set the [Data Name]. Click [OK] after setting..

[Project] -> [POU] -> Right-click [Program] -> [Add New Data]

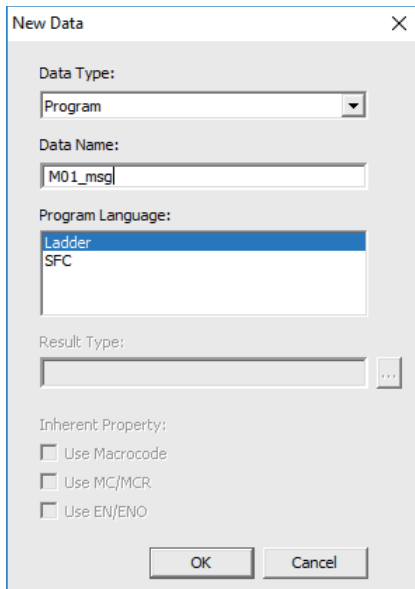

[Create line statement]

Create a line consisting of only NOPLF instruction on the "Program Editor" screen, and the following operation line statements can be edited.

Click [Edit] -> [Documentation] -> [Statement]

When a line containing an NOPLF instruction is double-clicked while editing line statement is permitted, a dialog is displayed like "Ladder display". Write message data on the dialog, and click [OK] or input [Enter].

5.8.10 Writing CNC Controller on GX Works2

This section describes how to transfer messages from GX Works2 to the CNC controller. The transfer procedure is the same as the transfer of sequence programs.

5.8.10.1 Operation Procedure

Display the "Write to PLC" screen by the following operation, and select the files to write.

[Online] -> [Write to PLC]

This subsection provides an example to transfer message data file M01_msg.WPG for Japanese display. Set the target memory in [(SRAM) Memory].

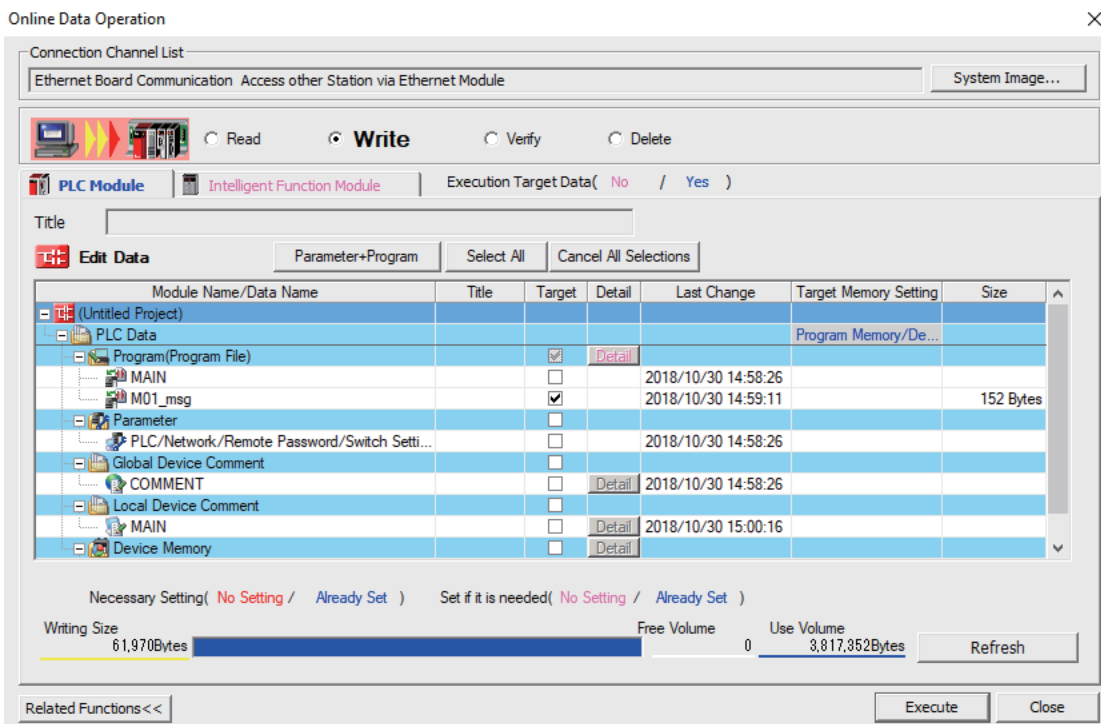

Note

- (1) Only one file of message data can be stored in the same language. When message data with different file names in the same language are overwritten, overwrite confirm dialog is displayed.
- (2) A message data password-protected file cannot be overwritten with a message data file of the same language with different file name. Write a new file after canceling the password of the stored message file or deleting the file.

5.8.10.2 Writing Operation

When messages are written from GX Works2, the CNC controller checks the data.

A conversion error will occur if there is a description exceeding the specifications. An error mark will be added to the description section in which the error occurred, and the data will be transferred to the last step.

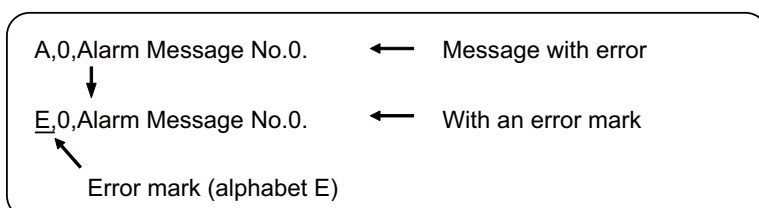

Note

- (1) The CNC controller does not display the message data file for which an error is generated.

5.8.10.3 Operation on Write Error

When a conversion error is generated, the following dialog is displayed on the GX Works2 screen.

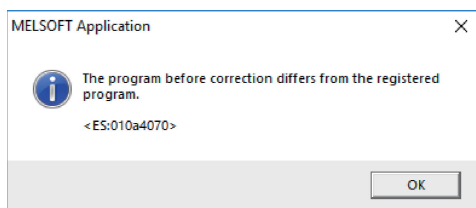

If the message file resulting in a conversion error is selected with the [File Selection] tab on the "Read from PLC" screen, the file name and title will change and be displayed as shown below.

If this message files are read to GX Works2, they are stored with file name of ERRMS-00. ("ERRMS-XX": XX is an error file number added from 0 in hexadecimal.)

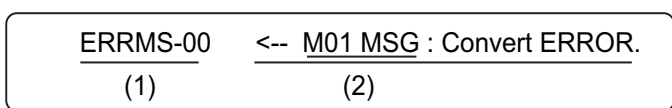

(1) File name at error + error number (hexadecimal)

(2) Title statement including transferred original file name

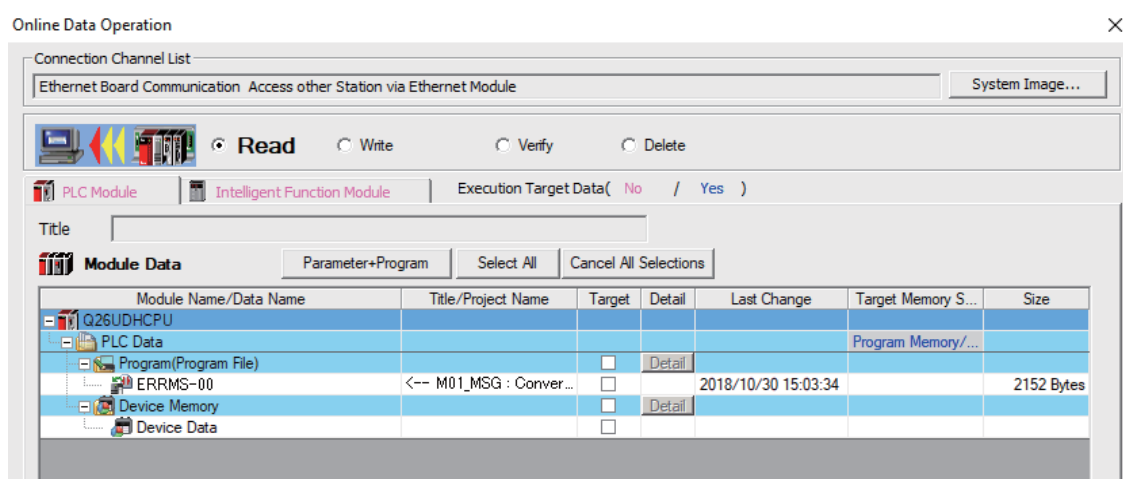

CAUTION

Do not read and use on GX Works2 message files for which a conversion error is generated. Unintended data are included, and malfunction may result.

5.8.10.4 Checking Errors

Errors can be checked using PLC verification function. For details on PLC verify function, refer to "5.6.7 Verifying the Sequence Programs".

Target Memory Setting: Select the data area storing the message data files.

Edit Data: Select transfer source message files in GX Works2.

Module Data: Select in the CNC controller the message file "ERRMES-00" for which error is generated.

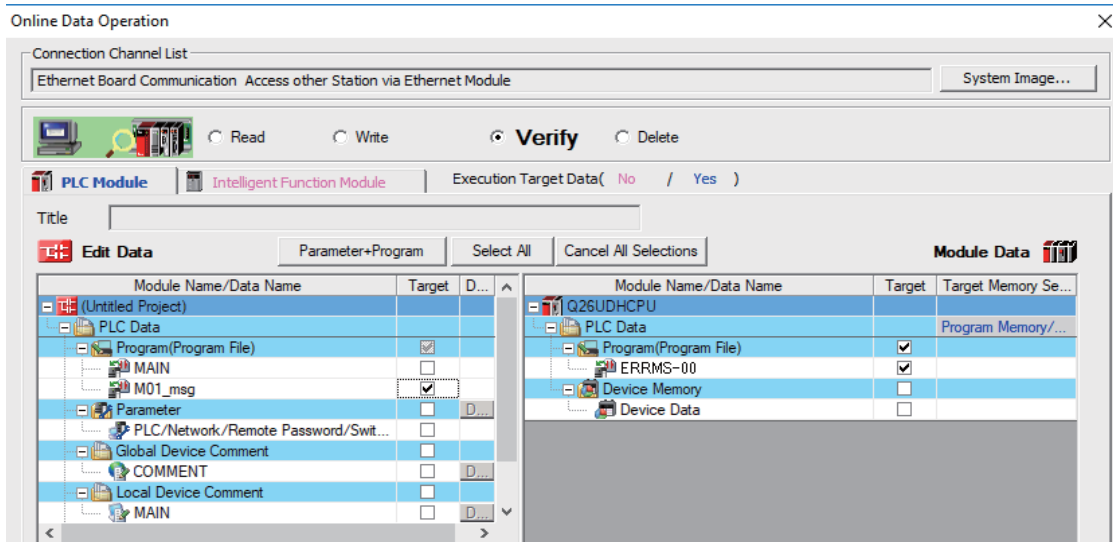

When PLC verification is executed, the verify result screen is displayed. When a file name is double-clicked, mismatched contents are displayed as shown in the example below. The PLC messages in the CNC controller are the steps with errors. Double-click mismatched part to display and edit the corresponding part on GX Works2 file. "<Memory>" indicates the GX Works2 side, and "<PLC>" the CNC controller side.

Source Project Name	(Untitled Project)	Destination Project Name	in Q26UDH PLC
Source Data Name	M01_msg	Destination Data Name	ERRMS-00
Current Hierarchy	Verify Result List -> [1]Program File		

Line	Step	Verify Source	Step	Verify Destination
1	0	NOPLF	0	NOPLF
2	1	A,0,Alarm Message No.0	1	E,0,Alarm Message No.0
3	15	NOPLF	15	NOPLF
4	16	O,1,9000,MELDAS 600 LADDER Ver1.0	16	O,1,9000,MELDAS 600 LADDER Ver1.0
5	35	NOPLF	35	NOPLF
6	36	P,1,Program restart	36	P,1,Program restart
7	48	NOPLF	48	NOPLF
8	49	M,1,0,[SP Axis]	49	M,1,0,[SP Axis]
9	60	NOPLF	60	NOPLF
10	61	END	61	END

↑
↑

GX Works2

CNC controller

Result with error is displayed in red

5.8.11 Reading and Verifying Message Data on CNC Controller

This section describes how to read messages from the CNC controller to GX Works2 and verify them. The procedure for reading and verifying is the same as reading and verifying sequence programs.

5.8.11.1 Menu Selection and Screen Operation

For details of the operating procedures, refer to the following sections.

Read: "5.6.5 Reading Sequence Programs from CNC Controller"

Verify: "5.6.7 Verifying the Sequence Programs"

5.8.12 How to Use on GX Works2 Message Data for GX Developer

Message data created for GX Developer can be used on GX Works2 in two ways according to the save format of the original message data.

5.8.12.1 When Data are Saved in Format Used in General Tools

- (1) Transform the message data to CSV file on GX Converter. (*1)
 - (2) Add three blank lines to the top of the CSV file in (1).
 - (3) Transform the character code of the CSV file in (2) to Unicode.
 - (4) Read the CSV file in (3) on GX Works2. (*2)
- (*1) For details on how to transform message data on GX Converter, refer to MELSEC PLC development tool (GX Developer) specifications manual for M800/M80 Series.
- (*2) Set the language on Windows appropriate for the language which the message data are written in.

5.8.12.2 When Data are Saved in GX Developer Format

- (1) Open the GX Developer format project storing the message data on GX Works2. (*1)
 - (2) Copy the message data in (1) to the GX Works2 project in which the data to be stored.
- (*1) For details how to open GX Developer format project on GX Works2, refer to "5.5.10.1 Reading Sequence Programs in GX Developer Format on GX Works2".

5.9 Creating Device Comment

None of the device comment specifications are specific to Mitsubishi Electric CNC. For details of development procedures, refer to "GX Works2 Operating Manual (Common)". This chapter provides the overview of the procedure for developing device comments including the development procedure and input/output procedure using general-purpose tool.

5.9.1 Development Procedure

There are two types of standard procedure for developing device comments as shown below.

■ Indirect input

This is a method to transform for GX Works2 using a generally available text editor and spreadsheet as well as a data conversion package. It is used when the amount of device comments is large and managed with commercial tools.

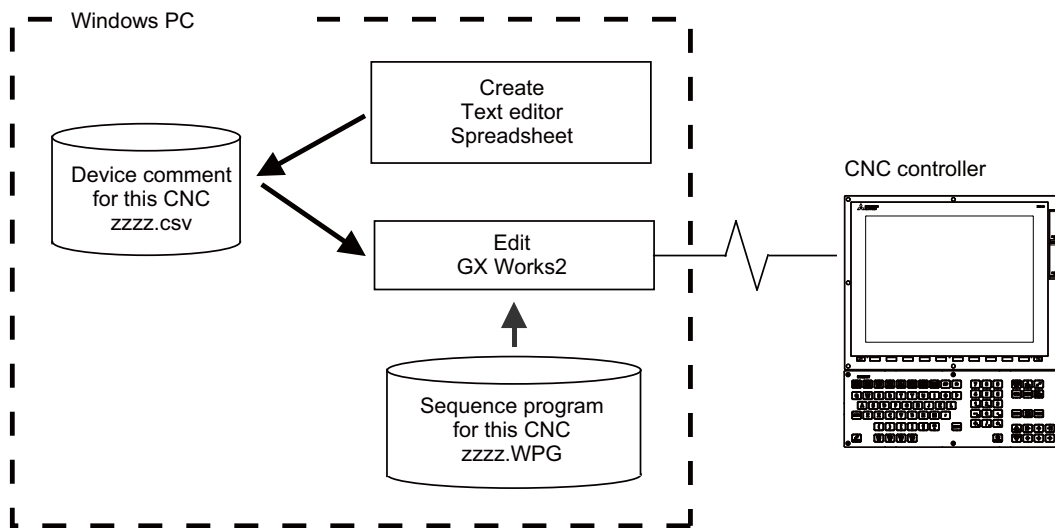

■ Note

(1) Only CSV files can be read. Unlike GX Developer, TXT files cannot be read.

■ Direct input

To input device comment directly from GX Works2 method. It is used when the amount of device comments is small and add and correct them.

5.9.2 Writing Method of Indirect Input

This section describes how to describe when creating using tools like spreadsheets. The following example is a device comment written with a spreadsheet.

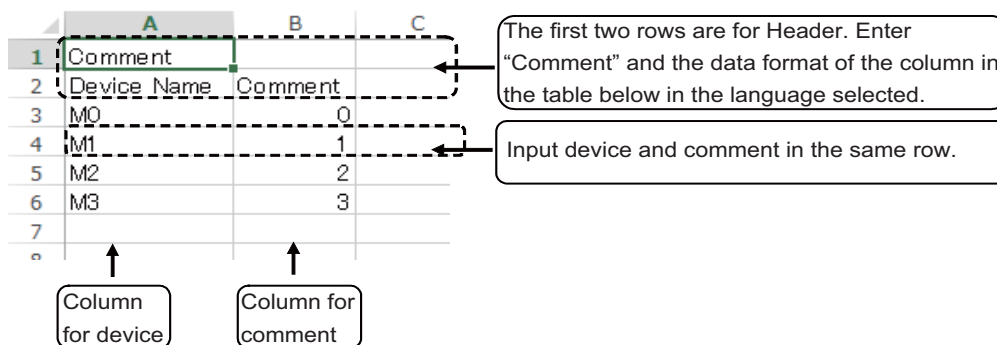

Data format of columns	Description
Device	<ul style="list-style-type: none"> Input of device is mandatory. Conversion cannot be done without device. Always describe a device. Device is a required item. Describe it in one-byte code.
Comment	<ul style="list-style-type: none"> Describe comment. If device in the same row is blank or incorrect, comment is not registered. Up to 32 one-byte characters can be described.

Note

(1) Device names cannot be set on GX Works2.

Save the above data in the Unicode format, and change the extension to ".csv".

The following example displays the above data with a text editor.

```

Comment
Device Name    Comment
M0 0
M1 1
M2 2
M3 3
    
```

5.9.3 Reading Comment Data on GX Works2

The comment data (CSV format) created with tools such as spreadsheet is read to GX Works2 as follows.

5.9.3.1 Reading to GX Works2

(1) Open the following screen by the following operation in the navigation window on GX Works2.

[Project] -> Right-click [Global Device Comment] -> [Read from CSV File]

or

[Project] -> [POU] -> Right-click [Local Device Comment] -> [Read from CSV File]

(2) Select a comment file (e.g. COMMENT.csv) on the following screen, and click [Open].

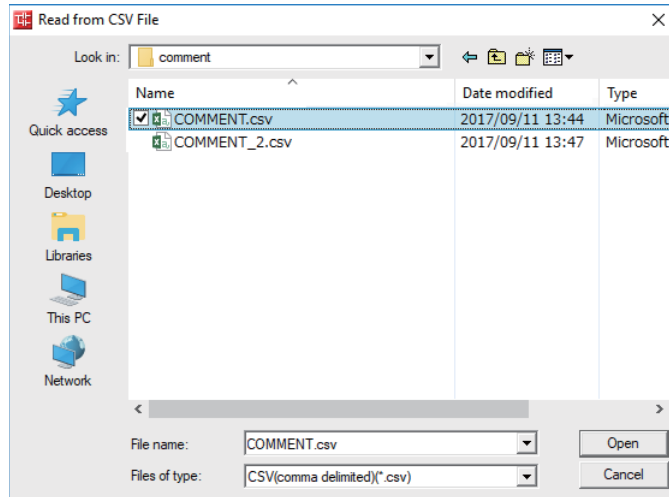

5.9.3.2 Precautions

If the region settings for the language in which comment files are written is different from that on Windows, characters are corrupted when written to the CNC, and cannot be read properly by built-in edit function. To avoid this issue, change the region setting on Windows to the one appropriate for the language to write comment files in before reading comment file in the CSV format to GX Works2.

Refer to "5.15.3 Multi-Language Data" for details.

5.9.4 Writing Device Comments to CNC Controller

This section describes how to write device comments from GX Works2 to the CNC controller.

5.9.4.1 Operation Procedure

- (1) Start the operation screen by the following operation on GX Works2.
[Online] -> [Write to PLC]
- (2) Select [Program Memory/Device Memory] from [Target Memory Setting] on the following screen, select device comment files to write, and click [Execute].

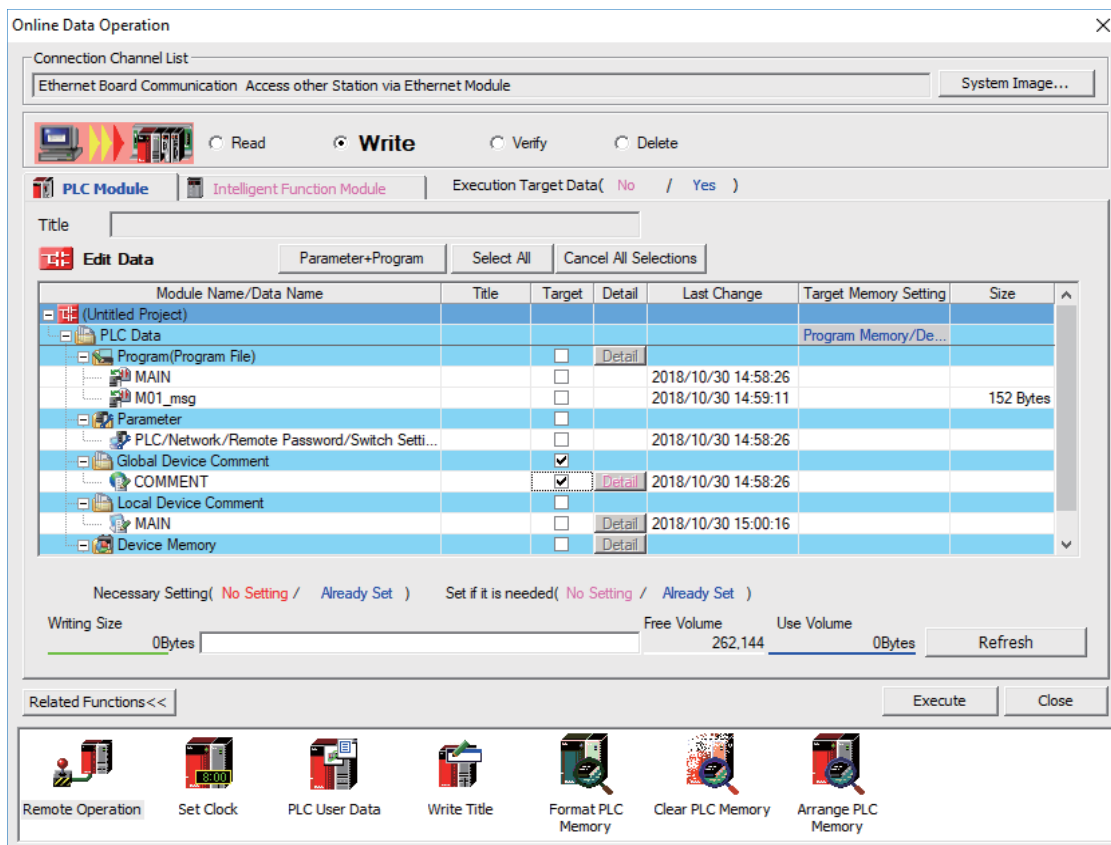

Note

- [Program Memory/Device Memory] is the only valid option for [Target Memory Setting].

5.9.5 Reading Device Comments from CNC Controller

This chapter describes how to read device comments to GX Works2 from the CNC controller.

5.9.5.1 Operation Procedure

- (1) Start the operation screen by the following operation on GX Works2.
 [Online] -> [Read from PLC]
- (2) After selecting [Program Memory/Device Memory] as [Target Memory Setting] on the following screen, select device comment file to be read, and click [Execute].

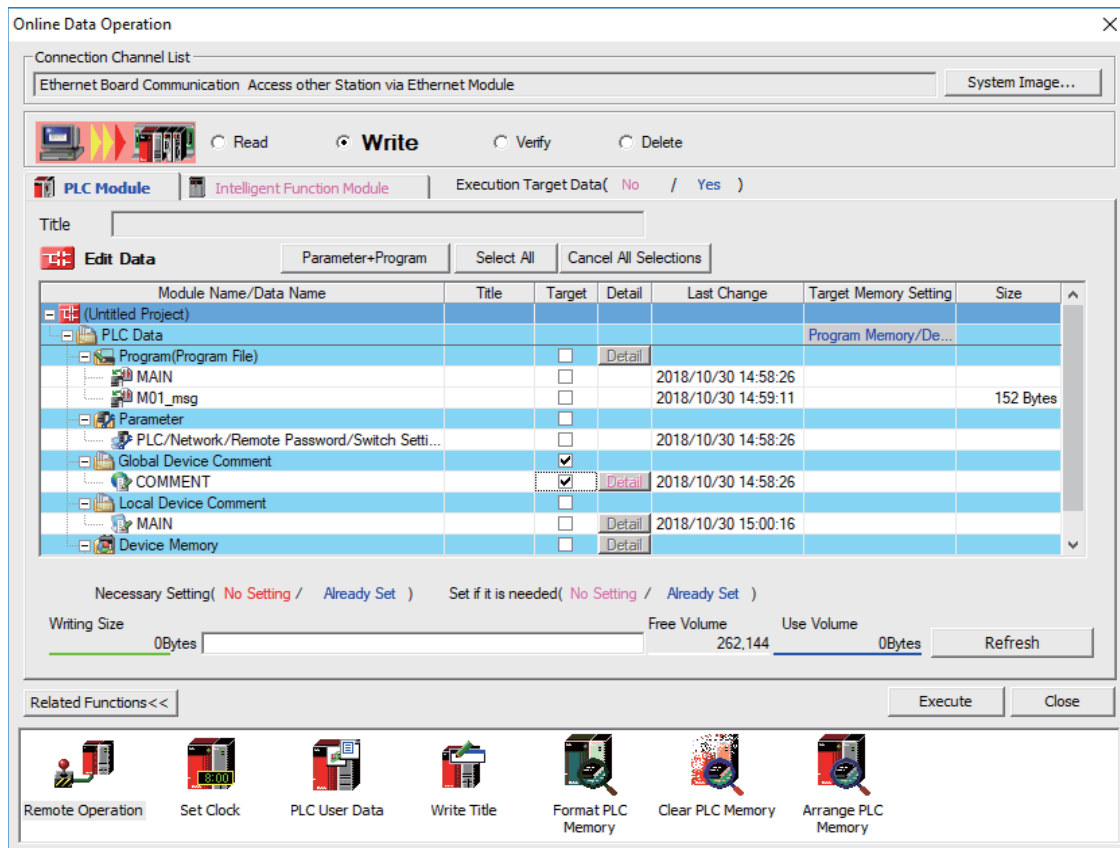

Note

- ◆ [Program Memory/Device Memory] is the only valid option for [Target Memory Setting].
- ◆ Click [Refresh] before reading data.

5.10 Creating Label

None of the label specifications are specific to Mitsubishi Electric CNC. For details on basic development procedure, refer to "GX Works2 Operating Manual (Simple Project)" and "GX Works2 Operating Manual (Structured Project)". This section outlines labels and describes development procedure, as well as the development procedure and input/output procedure using general-purpose tool.

Note

(1) Labels can be used when simple project (with labels) or structured project is selected.

5.10.1 Overview of Label

Labels are character strings representing devices. Labels enables sequence programs to be created without thinking of devices, and makes it easy to use sequence programs in different systems.

This section provides an example of sequence program when labels are used with ladder diagram.

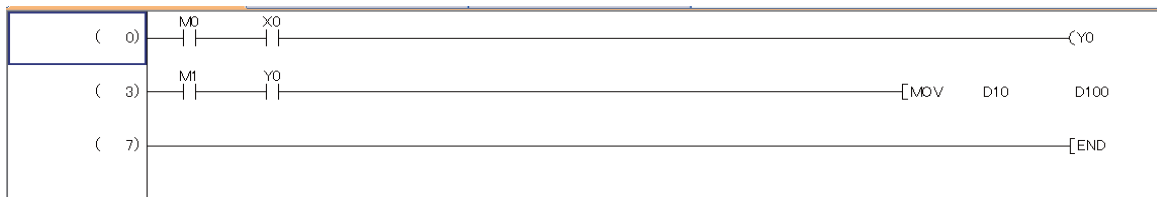

Replace devices with
character strings

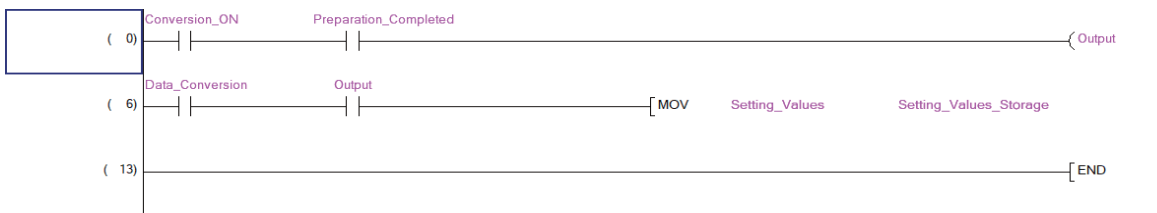

5.10.2 Development Procedure

There are two types of standard procedure for developing labels.

■ Indirect input

This is a method to transform for GX Works2 using a generally available text editor and spreadsheet as well as a data conversion package. Used when the amount of setting labels is large and managed with commercial tools.

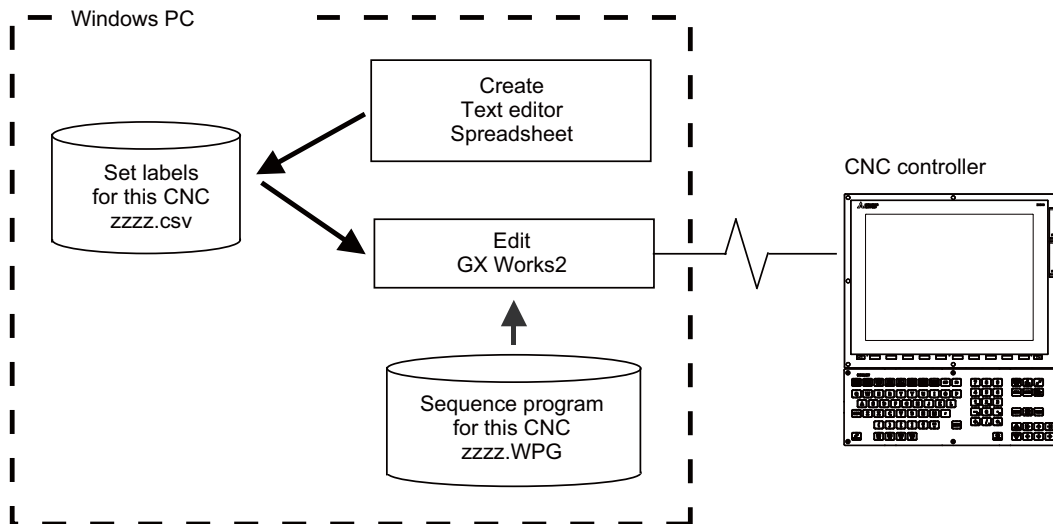

Note

(1) Only CSV files can be read. Unlike GX Developer, TXT files cannot be read.

■ Direct input

This is the method to set labels directly on GX Works2. It is used when adding and correcting a small number of labels.

5.10.3 Writing Method of Indirect Input

This section describes how to describe when creating label settings using tools like spreadsheet for each label type. The following example shows the label setting using spreadsheet.

■ Global label

	A	B	C	D	E	F	G	H	I	J
1	Label									
2	Class	Label Name	Data Type	Constant	Device	Comment	Remark	Relation wi	System Lal	Attribute
3	VAR_GLOBAL	DEV0	BOOL		M0	Device_0				
4	VAR_GLOBAL	DEV1	BOOL		M1	Device_1				
5	VAR_GLOBAL	DEV2	BOOL		M2	Device_2				
6	VAR_GLOBAL	DEV3	BOOL		M3	Device_3				
7	VAR_GLOBAL	DEV.W.1	INT		D0					
8	VAR_GLOBAL	DEV.W.2	INT							
9	VAR_GLOBAL_CONSTANT	NUM0	INT	10						
10										
11										

The first two rows are for Header. Input "Label" and column data format in the table below in an appropriate language.

Input class and label in the same row.

Data format of columns	Description
Class	<ul style="list-style-type: none"> Describe the class name of label. Conversion cannot be done without class name. Always describe a device. Types of class are described later.
Label name	<ul style="list-style-type: none"> Describe label name. Conversion cannot be done without label name. Always describe a device. Up to 32 one-byte characters can be described. Actual device names and reserved characters cannot be used.
Data type	<ul style="list-style-type: none"> Describe the data type of label. Conversion cannot be done without data type. Always describe a device. Data types are described later.
Constant	<ul style="list-style-type: none"> Describe the numeric value assigned to label when the class is VAR_GLOBAL_CONSTANT.
Device	<ul style="list-style-type: none"> Describe devices assigned to label. Automatically assigned when device is blank.
Comment	<ul style="list-style-type: none"> Describe comment of label. Up to 1024 one-byte characters can be described.
Remark	<ul style="list-style-type: none"> Describe supplementary information for comment of label. Up to 1024 one-byte characters can be described.
Relation with system label	Item related to system labels. Not supported by CNC controllers.
System label name	Item related to system labels. Not supported by CNC controllers.
Attribute	Item related to system labels. Not supported by CNC controllers.

Save the above data in the Unicode format, and change the extension to ".csv".

■ Local label for program

	A	B	C	D	E	F
1	Label					
2	Class	Label Name	Data Type	Constant	Device	Comment
3	VAR	DEV0	BOOL			Device_0
4	VAR	DEV1	BOOL			Device_1
5	VAR	DEV2	BOOL			Device_2
6	VAR	DEV3	BOOL			Device_3
7	VAR	DEV_W_1	INT			
8	VAR	DEV_W_2	INT			
9	VAR_CONSNUMO		INT	10		
10						
11						
12						

The first two rows are for Header. Input "Label" and the column data format in the table below in an appropriate language.

Input class, label and other information in the same row.

Data format of columns	Description
Class	<ul style="list-style-type: none"> Describe the class name of label. Conversion cannot be done without class name. Always describe a device. Types of class are described later.
Label name	<ul style="list-style-type: none"> Describe label name. Conversion cannot be done without label name. Always describe a device. Up to 32 one-byte characters can be described. Actual device names and reserved characters cannot be used.
Data type	<ul style="list-style-type: none"> Describe the data type of label. Conversion cannot be done without data type. Always describe a device. Data types are described later.
Constant	<ul style="list-style-type: none"> Describe numeric value assigned to label when the class is VAR_CONSTANT.
Device	<ul style="list-style-type: none"> Cannot be set for local label.
Comment	<ul style="list-style-type: none"> Describe comment of label. Up to 1024 one-byte characters can be described.

Save the above data in the Unicode format, and change the extension to ".csv".

■ Local label for function block

	A	B	C	D	E	F	G
1	FB Label						The first two rows are for Header. Input "Label" and the column data format in the table below in an appropriate language.
2	Class	Label Name	Data Type	Constant	Comment		
3	VAR	HOLD_1	HOLD				Input class, label name and other information in the same row.
4	VAR_INPUTON1		BOOL				
5	VAR_INPUTOFF1		BOOL				
6	VAR_IN_OUTIN_OUT1		BOOL				
7	VAR_CONENUMO		INT	10			
8	VAR_OUTEOU1		BOOL				
9							
10							

Data format of columns	Description
Class	<ul style="list-style-type: none"> Describe the class name of label. Conversion cannot be done without class name. Always describe a device. Types of class are described later.
Label name	<ul style="list-style-type: none"> Describe label name. Conversion cannot be done without label name. Always describe a device. Up to 32 one-byte characters can be described. Actual device names and reserved characters cannot be used.
Data type	<ul style="list-style-type: none"> Describe the data type of label. Conversion cannot be done without data type. Always describe a device. Data types are described later.
Constant	<ul style="list-style-type: none"> Describe the numeric value assigned to the label when the class is "VAR_CONSTANT".
Device	<ul style="list-style-type: none"> Cannot be set for local label.
Comment	<ul style="list-style-type: none"> Describe comment of label. Up to 1024 one-byte characters can be described.

Save the above data in the Unicode format, and change the extension to ".csv".

For details on function blocks (FB), refer to "5.11 Creating Function Block", "GX Works2 Operating Manual (Simple Project, Function Block)" and "GX Works2 Operating Manual (Structured Project)".

5.10.4 Reading Label Setting on GX Works2

Label setting (CSV format) created using tools such as spreadsheet is read to GX Works2 as follows.

5.10.4.1 Reading to GX Works2

Open the read screen by the following operation in the navigation window on GX Works2.

■ Global label

[Project] -> Right-click [Global Label] -> [Read from CSV File]

■ Local label for program

[Project] -> [POU] -> [Program] -> [Program Name] -> Right-click [Local Label] -> [Read from CSV File]

■ Local labels for function blocks

[Project] -> [POU] -> [FB_Pool] -> [FB name] -> Right-click [Local Label] -> [Read from CSV File]

Select a label setting file on the following screen, and click [Open].

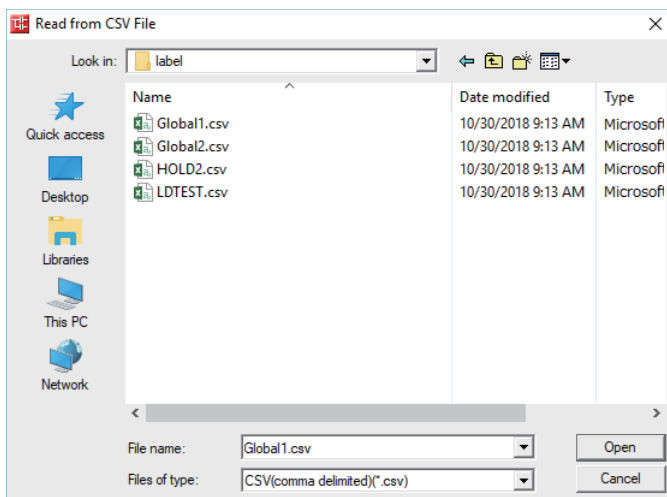

5.10.4.2 Precautions

If the language the label setting file is written in is different from the region setting on Windows, the characters will corrupt when written to the CNC, and cannot be read properly by built-in edit functions. To avoid this issue, change the Windows region setting to the appropriate one for the language of the label setting file, before reading the label setting file in the CSV format to GX Works2.

Refer to "5.17.3 Multi-language Data" for details.

5.10.5 Writing Label Setting to CNC Controller

This section describes how to write label setting from GX Works2 to the CNC controller (particularly restrictions and operation specific to this CNC).

5.10.5.1 Operation Procedure

(1) Start the operation screen by the following operation on GX Works2.

[Online] -> [Write to PLC]

(2) After selecting [Program Memory/Device Memory] as the symbolic information as [Target Memory Setting] on the following screen, [Program Memory/Device Memory] as [Target Memory Setting] of PLC data, select the symbolic information file, and click [Execute].

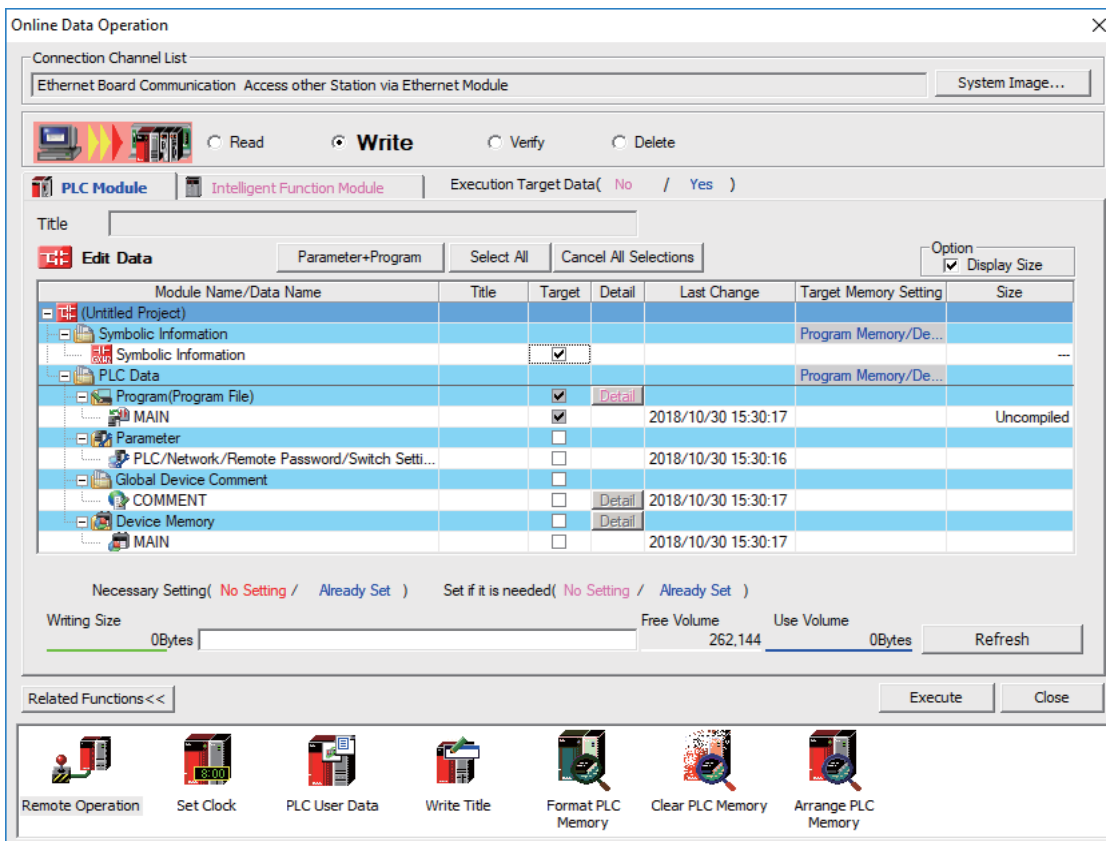

Note

- [Program Memory/Device Memory] is the only valid option for [Target Memory Setting].
- When symbolic information is written, sequence programs and FB are written as well as labels.

5.10.6 Reading Label Setting from CNC Controller

This section describes how to read label setting from the CNC controller to GX Works2 (particularly restrictions and operation specific to this CNC).

5.10.6.1 Operation Procedure

- (1) Start the operation screen by the following operation on GX Works2.
[Online] -> [Read from PLC]
- (2) After selecting [Program Memory/Device Memory] from [Target Memory Setting] on the following screen, select "GX Works2 (Simple project)", and click [Execute].

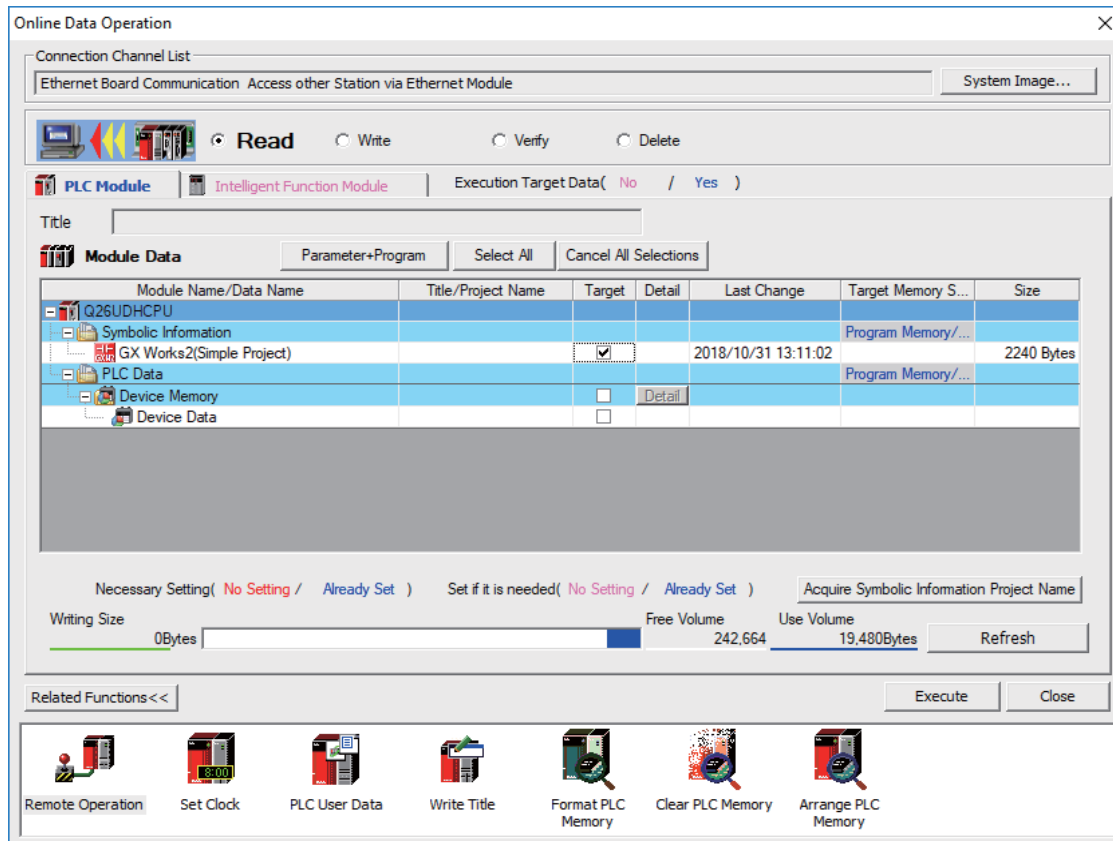

Note

- [Program Memory/Device Memory] is the only valid option for [Target Memory Setting].
- Click [Refresh] before reading data.
- For details on read parameters before reading symbolic information, refer to "5.5.8.6 Writing and Reading Parameters to CNC Controller".
- When symbolic information is read, sequence programs and FB are also read as well as labels.

5.10.7 Restrictions

The use of label setting on M8V series CNC controller has the following considerations. Exercise caution because if these considerations are not observed, sequence programs malfunction may result.

■ Built-in edit function

Even when label setting is written to the CNC controller, labels cannot be displayed or confirmed by built-in edit functions of the CNC.

■ System label

The CNC controller cannot use system labels.

■ Types of class

This table lists the class name that can be used in label setting on a CNC controller and the types of labels that can select each class name. Latch type labels cannot be used.

⊙ : Selectable, ×: Not selectable

Class name	Details	Labels that can be selected			
		Global label	Local label for program	(*2)	Local label for function block
VAR_GLOBAL	Global label assigned to device	⊙	×	×	×
VAR_GLOBAL_CONSTANT	Global label assigned to constant	⊙	×	×	×
VAR	Local label assigned to device	×	⊙	⊙	⊙
VAR_CONSTANT	Local label assigned to constant	×	⊙	⊙	⊙
VAR_RETAIN (*1)	Latch type local label	×	×	×	×
VAR_INPUT	Label used for inputting FB	×	×	⊙	⊙
VAR_OUTPUT	Label used for outputting FB	×	×	×	⊙
VAR_IN_OUT	Label used for inputting/outputting FB	×	×	×	⊙

(*1) To use latch devices on the CNC controller, assign user areas for L device and R device in "VAR_GLOBAL", and select latch as device set in the parameter.

(*2) Function can be selected when creating sequence programs with ST language.

■ Data types

This table lists the data types that can be used in label setting on the CNC controller. Besides these, the names of FBs, arrays and structures used can be set as data types.

For details on arrays and structures, refer to "GX Works2 Operating Manual (Common)".

◎ : Selectable, ×: Not selectable

Data type on GX Works2	Data type in CSV file	Support on the CNC controller	
		Ladder	ST
Bit	BOOL	◎	◎
Word [signed]	INT	◎	◎
Double word [signed]	DINT	◎	◎
Word [unsigned]/Bit string [16 bit]	WORD	×	◎
Double word [unsigned]/Bit string [32 bit]	DWORD	×	◎
FLOAT (Single Precision)	REAL	◎	◎
FLOAT (Double Precision)	LREAL	◎	◎
String (32)	STRING[32]	◎	◎
Time	TIME	×	◎
Timer	TIMER	◎	×
Counter	COUNTER	◎	×
Retentive timer	RETENTIVETIMER	◎	×
Pointer	POINTER	◎	×

■ Devices assigned automatically

This table lists devices that can be assigned automatically to labels on the CNC controller along with cautions.

Do not use devices not listed here as devices assigned automatically.

Data type of device	Usable device	Precaution
Word device	D device, W device	Do not set the range set for project-common device as device assigned automatically
Bit device	M device, B device	Do not set the range set for project-common device as device assigned automatically
Pointer	P device	To set device assigned automatically, set common pointer No in [PLC Parameter] -> [PLC System]
Timer	T device	Do not set the range set for device assigned automatically as a variable time
Accumulated timer	ST device	Do not set the range set for device assigned automatically as a variable timer
Counter	C device	Do not set the range set for device assigned automatically as variable counter

5.11 Creating Function Block

None of the function block (FB) specifications are specific to Mitsubishi Electric CNC. For details on basic procedures for developing and using FB, refer to "GX Works2 Operating Manual (Simple Project, Function Block)" and "GX Works2 Operating Manual (Structured Project)". This section provides the overview of FB, as well as the procedure for inputting to and outputting from the CNC controller.

Note

- (1) FB can be used only when simple project (with labels) or structured project is selected.
- (2) GX Works2 does not support the macro function of GX Developer. Use FB instead.

5.11.1 Overview of Function Block

An FB is designed to convert a ladder block, which is used repeatedly in a sequence program, into a component to be utilized in a sequence program. FB improves the readability and efficiency in creating sequence programs, although the use of FB does not reduce the number of steps in sequence programs.

This section provides an example of sequence program using FB.

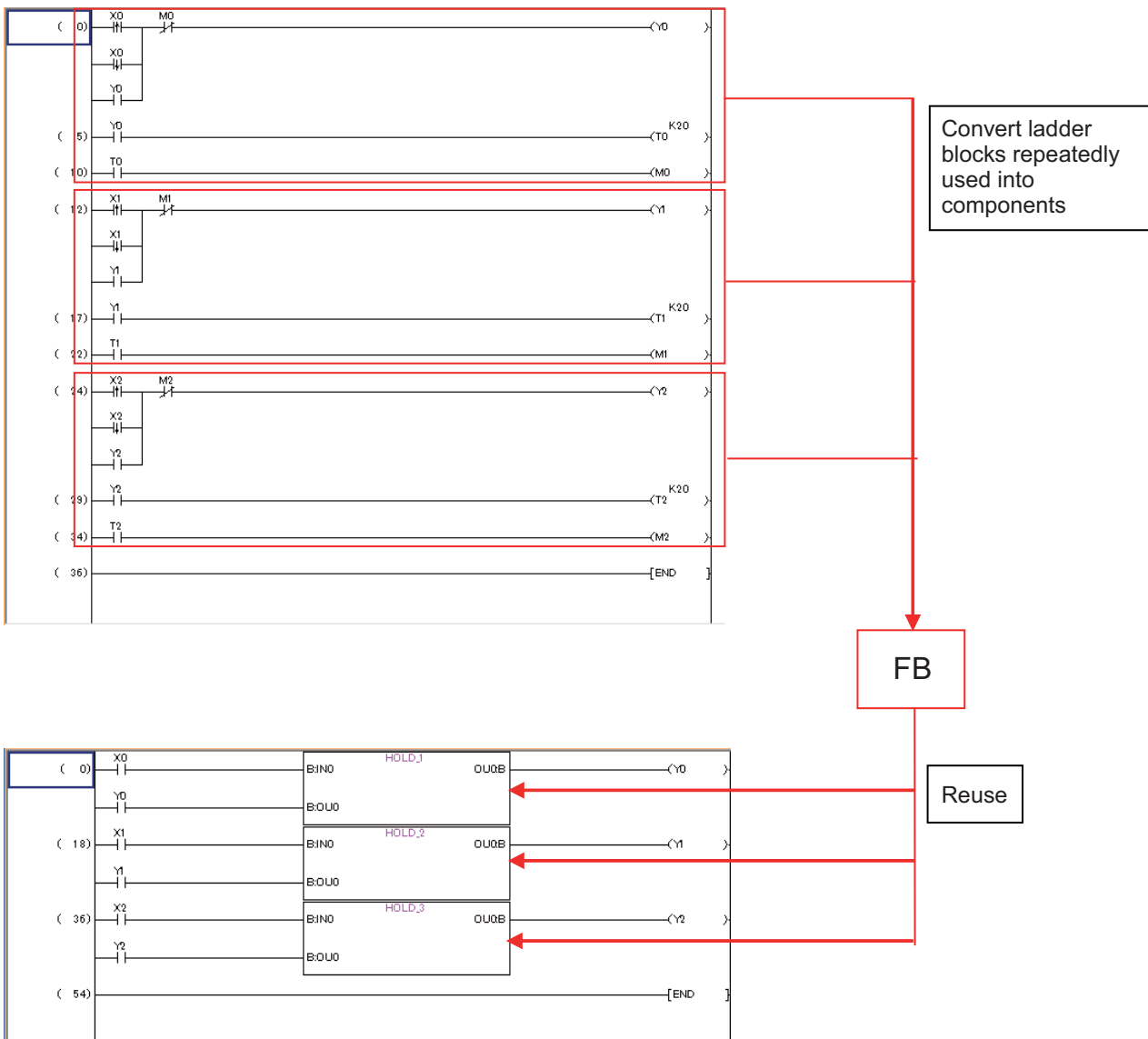

5.11.2 Write Function Block to CNC Controller

This section describes how to write FB from GX Works2 to the CNC controller (particularly restrictions and operation specific to this CNC).

5.11.2.1 Operation Procedure

- (1) Start the operation screen by the following operation on GX Works2.
[Online] -> [Write to PLC]
- (2) After selecting [Program Memory/Device Memory] as the symbolic information as [Target Memory Setting] on the following screen, [Program Memory/Device Memory] as [Target Memory Setting] of PLC data, select the symbolic information file, and click [Execute].

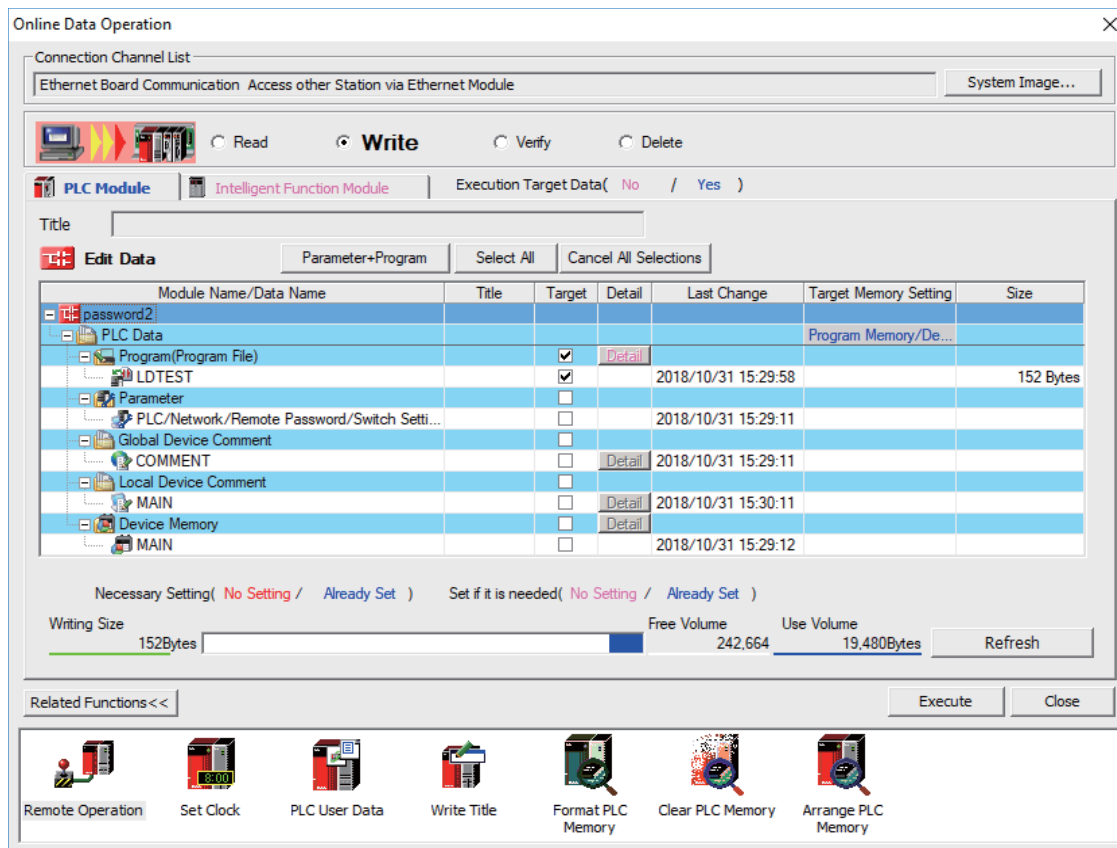

Note

- ◆ [Program Memory/Device Memory] is the only valid option for [Target Memory Setting].
- ◆ When symbolic information is written, sequence programs and labels are also written as well as FB.

5.11.3 Reading Function Blocks from CNC Controller

This section describes how to read FB from the CNC controller to GX Works2 (particularly restrictions and operation specific to this CNC).

5.11.3.1 Operation Procedure

(1) Start the operation screen by the following operation on GX Works2.

[Online] -> [Read from PLC]

(2) Select [Program Memory/Device Memory] as [Target Memory Setting] on the following screen, select "GX Works2(Simple Project)" or "GX Works2(Structured Project)", and click [Execute].

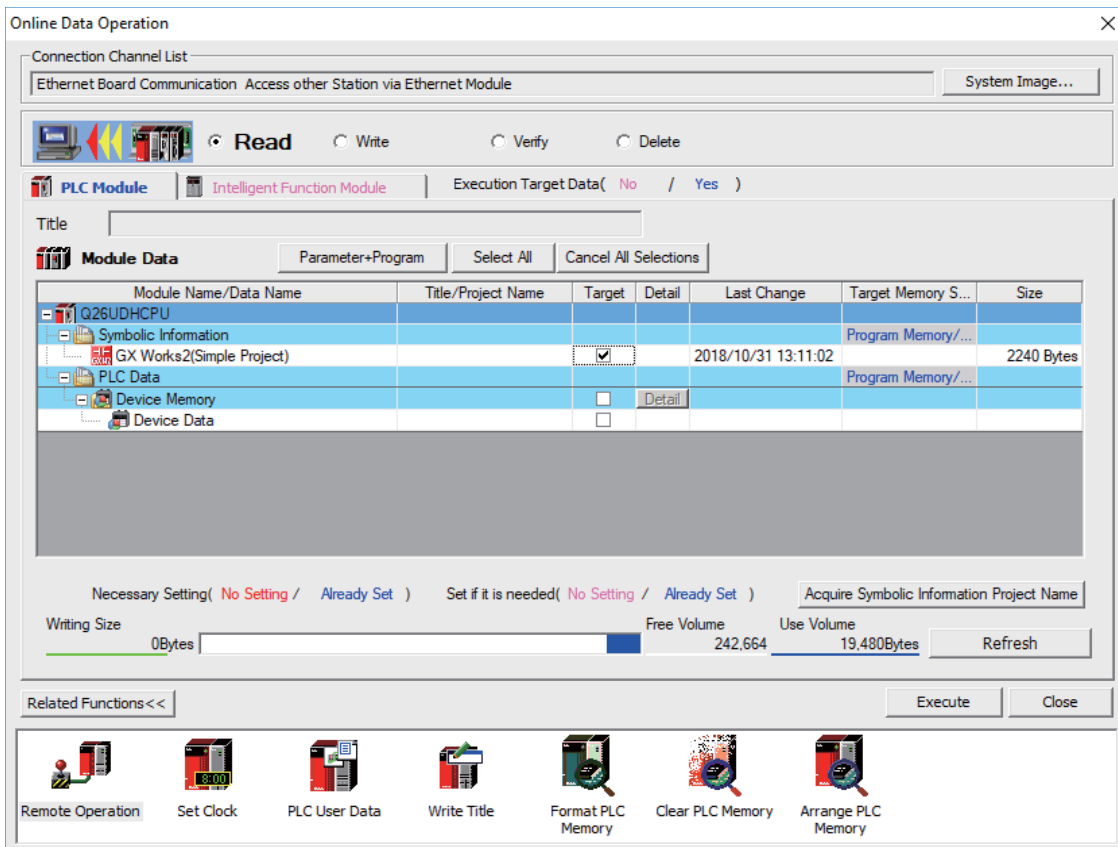

Note

- [Program Memory/Device Memory] is the only valid option for [Target Memory Setting].
- Click [Refresh] before reading data.
- For details on read parameters before reading symbolic information, refer to "5.5.8.6 Writing and Reading Parameters to CNC Controller".
- When symbolic information is read, sequence programs and labels as well as FB are read.

5.11.4 Restrictions

The use of FB on M8V series CNC controller has the following considerations. Exercise caution because if these considerations are not observed, malfunction of sequence programs may result.

■ Built-in edit function

Even when sequence programs with FB are written to the CNC controller, FB is not displayed on the built-in edit function of the CNC, but actual ladder (ladder with labels and functional blocks compiled) is displayed.

■ Nesting of FB

FB can be nested within FB. Nesting level of each language (ladder diagram or ST language) for each project is as follows.

		Simple project (without labels)	Simple project (with labels)	Structured project
Ladder Diagram		-	One layer	One layer
ST Language	Macro-type FB (*1)	-	Four layers	Four layers
	Subroutine-type FB (*1)	-	-	15 layers

(*1) You can select macro-type FB or subroutine-type FB only in structured project.

FB of simple project (with labels) is macro-type.

In structured project, subroutine-type FB cannot be called from the program whose programming language is ladder diagram.

When selecting subroutine-type FB, the pointer of the automatically-assigned device is used. For details, refer to "GX Works2 Operating Manual (Structured Project)".

Follow the procedure below to set macro-type FB or subroutine-type FB.

- (1) Create or open a structured project (ST language).
- (2) Select [Project] - [POU] - [FB/FUN] - [New Data].
- (3) Check or uncheck "Use Macrocode" under "Inherent Property":
 - Checked: Macro-type FB
 - Unchecked: Subroutine-type FB

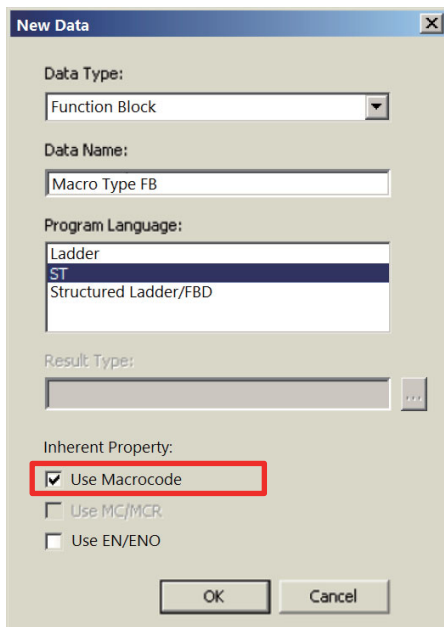

5.12 File Password Function

File password function prevents programs and other data in the CNC from being read or written by programming tools. A password can be set for each file.

There are some differences in the file password function specifications between GX Works2 and GX Developer. For details, refer to "Differences of password operation between GX Works2 and GX Developer" in "5.12.6 File Password: Cautions on Setting".

5.12.1 Data Protected by a File Password

File password can be set for sequence programs, device comments, and PLC messages in the CNC controller to read- or write-protect them. Set a password using 4 one-byte alphanumeric characters. (Capital and small letters are recognized.)

5.12.2 File Password Function

Passwords can be registered, changed, deleted, and unlocked from GX Works2.

- ♦ Registration and change of a file password sets a password.
- ♦ Deletion of a file password deletes a password.
- ♦ Unlock of a file password temporarily unlocks a password set for a program file.

5.12.3 File Password Attributes

A file password has Write attribute (enable/disable writing) and Read attribute (enable/disable reading).

The following attributes can be set from GX Works2.

- ♦ Write Protection: Writing and editing are prohibited
- ♦ Read/Write Protection: Reading, verifying, writing, and editing are prohibited

5.12.4 Outline of File Password Setting

■ Registering a File Password

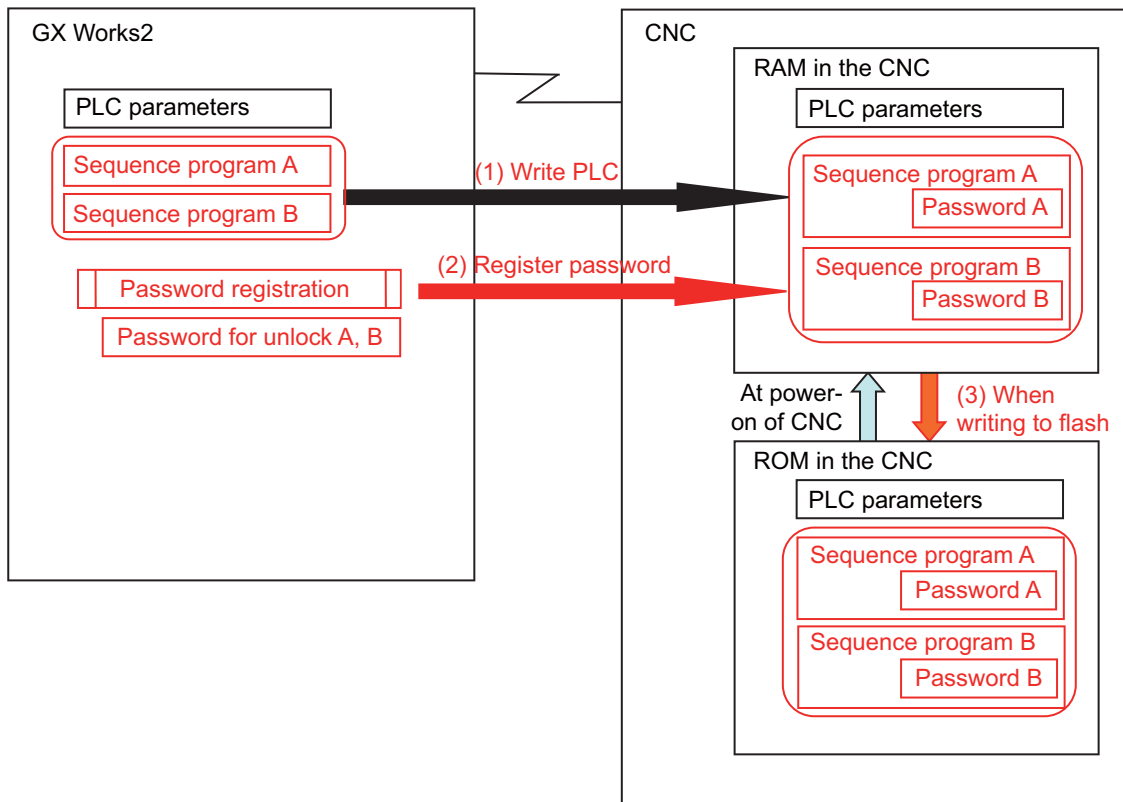

- (1) Save sequence programs in the RAM in the CNC by writing to PLC.
- (2) To read- or write-protect a file, register a file password. Registering a file password on GX Works2 sets the file password information (file password and file password attribute) of each sequence program in the CNC.
- (3) When PLC is written to flash ROM, data containing file password information is saved in the ROM in the CNC.

■ Work with a password-protected file

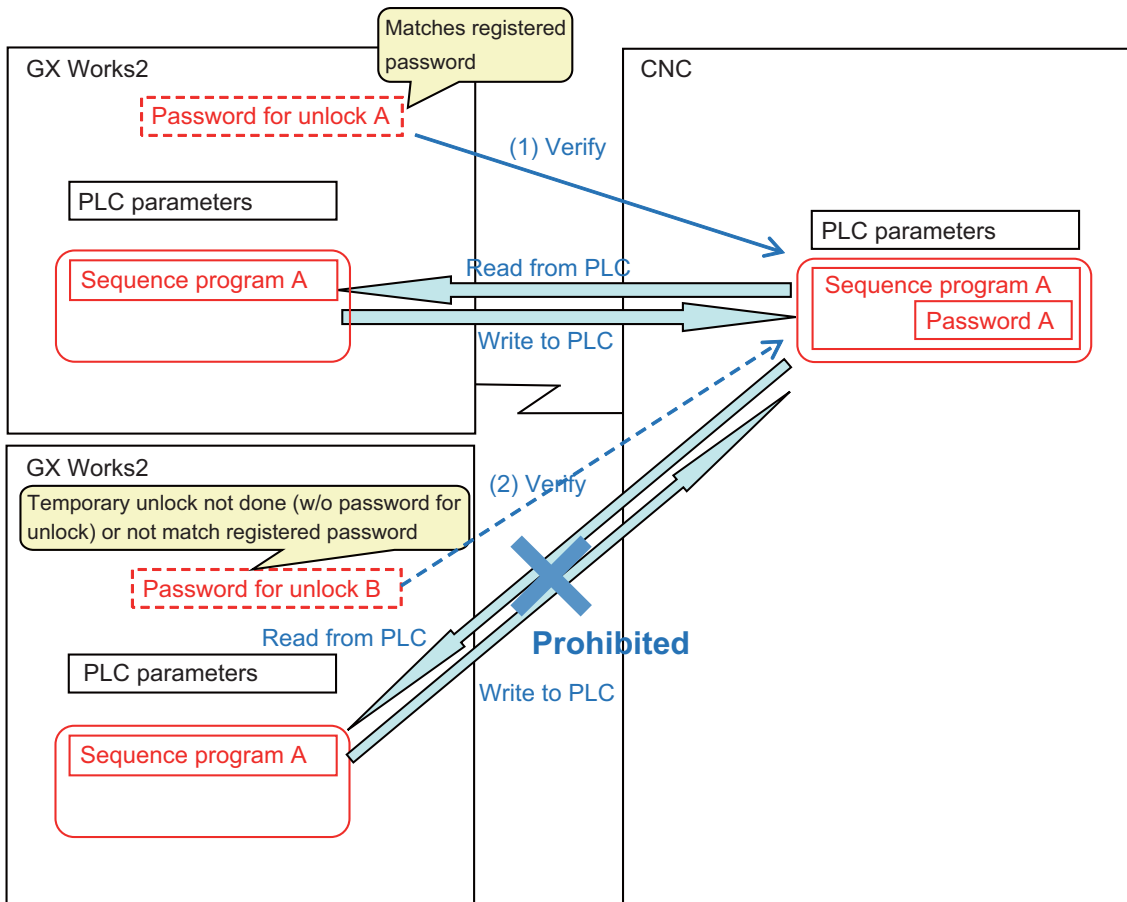

- (1) To work with a password-protected file, temporarily unlock the file password.
 A file password for unlock is set in GX Works2 when a file password is temporarily unlocked. A file password can be temporarily unlocked only on the GX Works2 on which a password for unlock was set.
 When GX Works2 on which a password for unlock was set is restarted, temporarily unlock a file password again. When the file is worked with on GX Works2, a password for unlock is sent to the CNC.
 The CNC verifies this password for unlock by comparing it with the registered password.
 When the password is authenticated, the CNC executes the file operation.

Note

- Password setting is retained even after a password-protected file is overwritten.
- (2) When temporary unlock of a file password is not done on the GX Works2, or when the password for unlock is different from the previously registered password, password verification fails, and file operation is not executed.

5.12.5 Checking the File Password Registration Status

You can check that a password is registered to a file in the CNC by using the values of special registers SD553 to SD556. Monitoring the values of the special registers prevents you from forgetting to register the password.

The password registration can be checked by a project basis. Bit0 to bit5 of each special register correspond to the project Nos. 1 to 6. The corresponding bit value of each project changes depending on the status of the password registration.

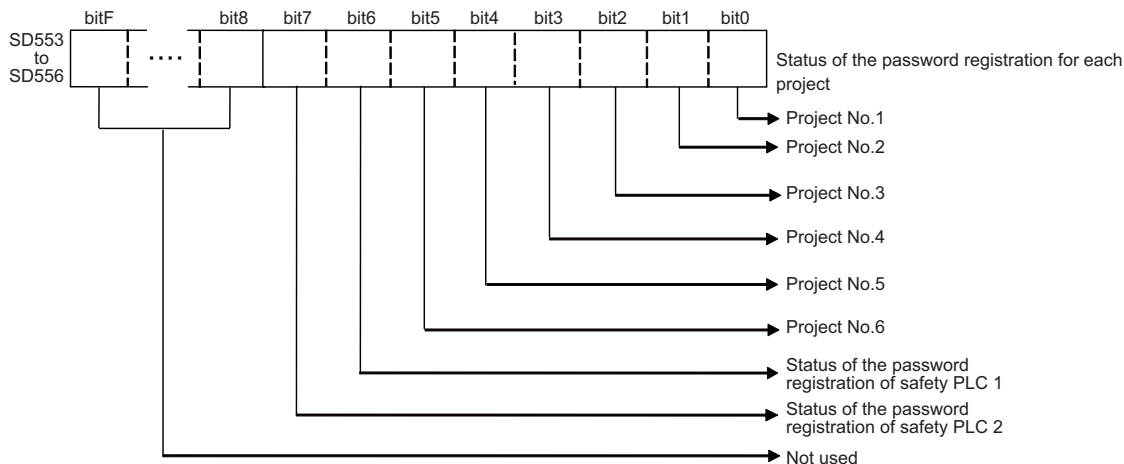

The values of the special registers change depending on the status of the password registration for stored file. However, the target file of the register and condition to change the value differ for the respective registers. For details, refer to the following table.

Special register	Target file	Bit value and its condition corresponding to project No.
SD553	Sequence programs	0 (When at least one password is registered) 1 (Other cases)
SD554	Sequence programs	0 (When all files are protected by passwords) 1 (Other cases)
SD555	PLC message, device comment	0 (When at least one password is registered) 1 (Other cases)
SD556	PLC message, device comment	0 (When all files are protected by passwords) 1 (Other cases)

Note that when no target file is stored in the project, the bit which corresponds to the project is "0".

Including each special register in a sequence program enables the CNC to stop the operation or to display an alarm, when a password has not been registered.

In the example below, PLC message is displayed when no password is registered for the ladder file of project 1. This prevents you from forgetting to register the password. (Refer to "5.8 PLC Message Development")

Example of a sequence program

When the value of SD553 is not "0", "F0" is turned ON.

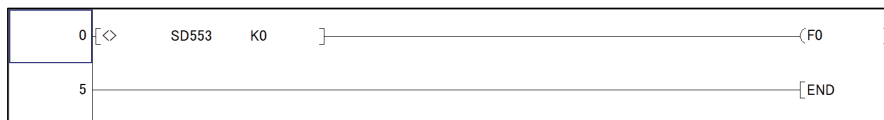

Example of a PLC message

When "F0" is turned ON, an PLC message is displayed.

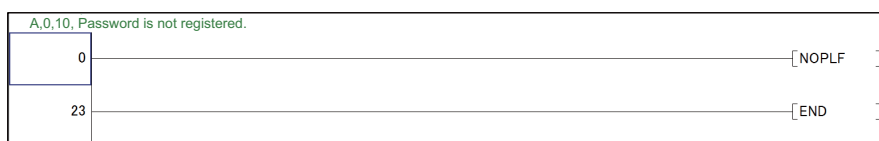

5.12.6 File Password: Cautions on Setting

When you forgot the password

If a registered password is forgotten, file operation other than Format PLC Memory becomes impossible. Format PC memory if the registered password is forgotten. Not only the password but all data will be cleared; recover data by opening deleted file on GX Works2 and write it to PLC again.

When reading file

When password-protected files are read from the CNC controller to GX Works2, password information is not read. This means that password is not set even if the read file is written to the CNC controller again.

Precaution for setting file password to simple project (with labels)

When at least one file password is registered to a sequence program which was written to a CNC from simple project, programs with no password set also are required to input password to be read or written, not only the program protected by the password.

When a sequence program is created by simple project, password registration only for the specific program cannot be performed.

Differences of password operation between GX Works2 and GX Developer

There are some differences for password operation between GX Works2 and GX Developer. Read the following contents thoroughly, and make sure not to forget the password registration.

■ Behavior when a password is registered and a project is restarted

When you use GX Developer, a password can be set and saved for a sequence program of GX Developer project which has been written to a CNC. Whereas a password is canceled for a sequence program of GX Works2 project when the same operation is performed using GX Works2.

[Behavior of GX Developer]

1. Write a file to a CNC from GX Developer.

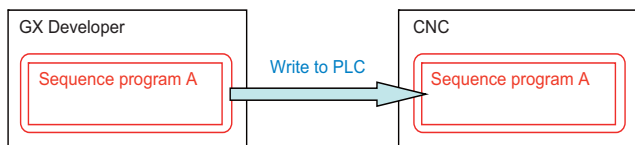

2. Register a password from GX Developer.

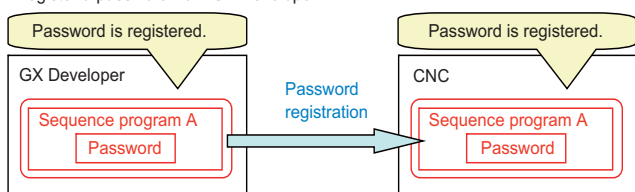

3. Save the project and restart GX Developer.

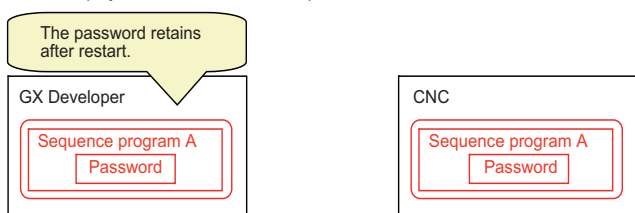

[Behavior of GX Works2]

1. Write a file to a CNC from GX Works2.

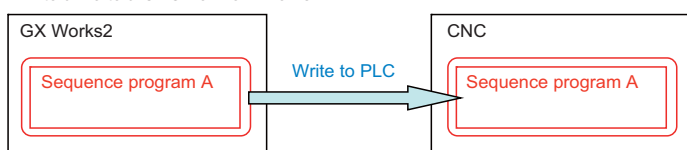

2. Register a password from GX Works2.

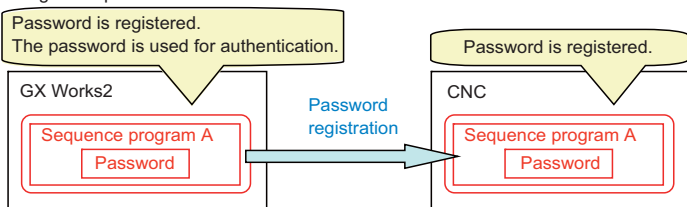

3. Save the project and restart GX Works2.

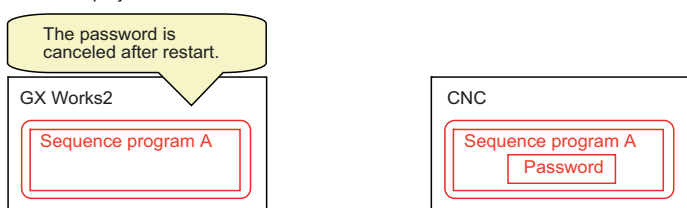

■ Behavior after a CNC is formatted

When a file protected by a password is read to GX works2 from a CNC, and then the file is written to the same CNC again after formatting the CNC, the password of the file is canceled.

When GX Developer is used in the same situation, the password retains for the file in the CNC.

When you use GX Works2, make sure not to forget to register a password again after write to PLC.

When no password is registered to the file, the bit values of the special registers SD553 to SD556 corresponding to the project are "1". (Refer to "5.12.5 Checking the File Password Registration Status")

[Behavior of GX Developer]

1. Read a file protected by a password to GX Developer from a CNC.

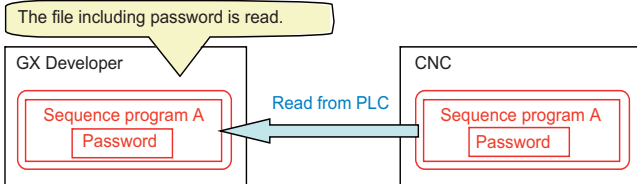

2. Format the CNC.

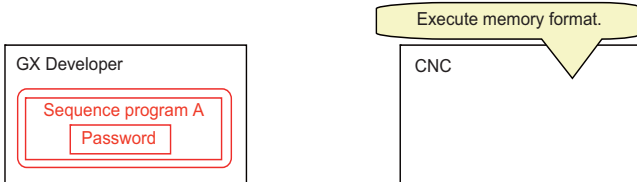

3. Write the file to the CNC from GX Developer.

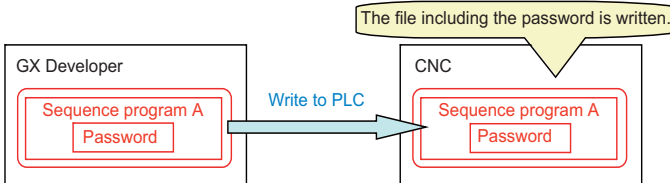

[Behavior of GX Works2]

1. Read a file protected by a password to GX Works2 from a CNC.

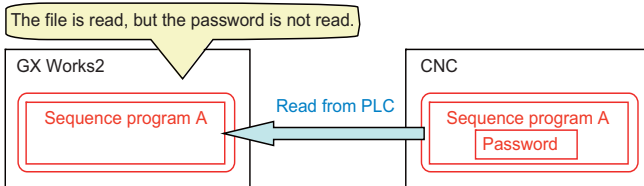

2. Format the CNC.

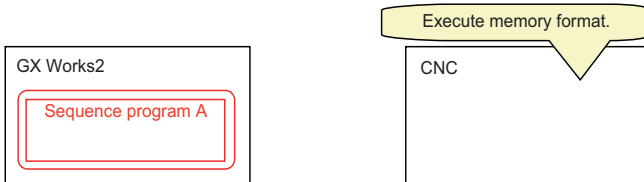

3. Write the file to the CNC from GX Works2.

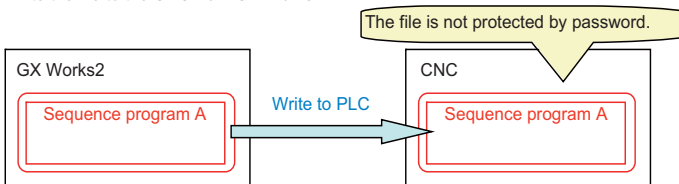

■ Behavior when an existing file is to be copied to another CNC

When a file protected by a password is read to GX works2 from a CNC, and then the file is written to another CNC, the password of the file is canceled.

When GX Developer is used in the same situation, the password retains for the file in another CNC.

When you use GX Works2, make sure not to forget to register a password again after write to PLC.

When no password is registered to the file, the bit values of the special registers SD553 to SD556 corresponding to the project are "1". (Refer to "5.12.5 Checking the File Password Registration Status")

[Behavior of GX Developer]

1. Read a file protected by a password to GX Developer from a CNC.

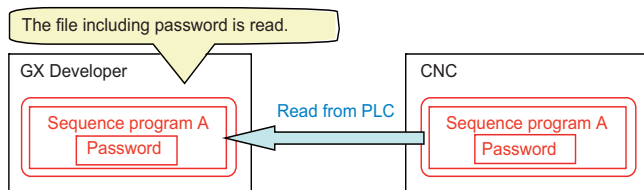

2. Prepare another CNC.

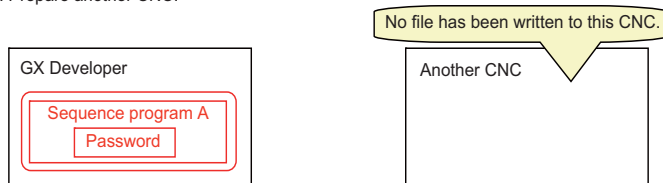

3. Write the file to another CNC from GX Developer.

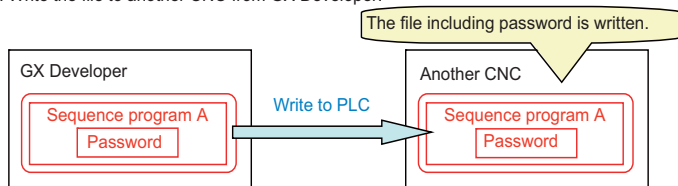

[Behavior of GX Works2]

1. Read a file protected by a password to GX Works2 from a CNC.

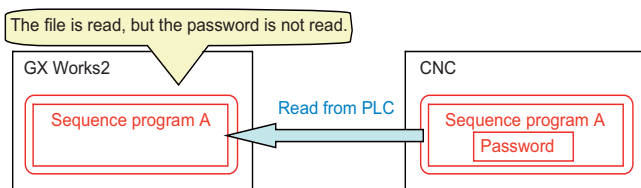

2. Prepare another CNC.

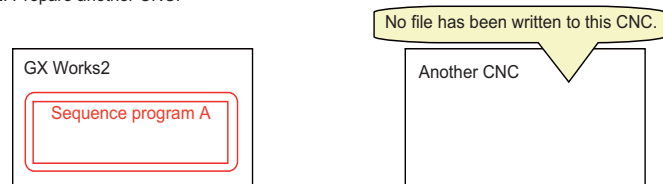

3. Write the file to another CNC from GX Works2.

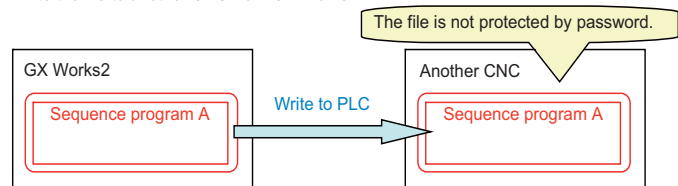

5.12.7 File Password Setting Procedure

5.12.7.1 Registering New File Password

The flow of file password new setting procedure is as follows.

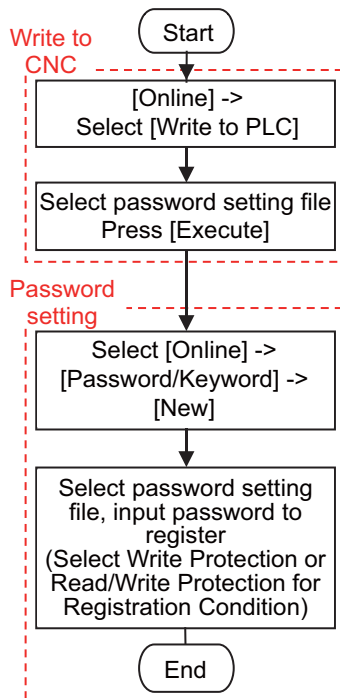

(1) Select [Online] - [Write to PLC] to display the following "Online Data Operation" screen.

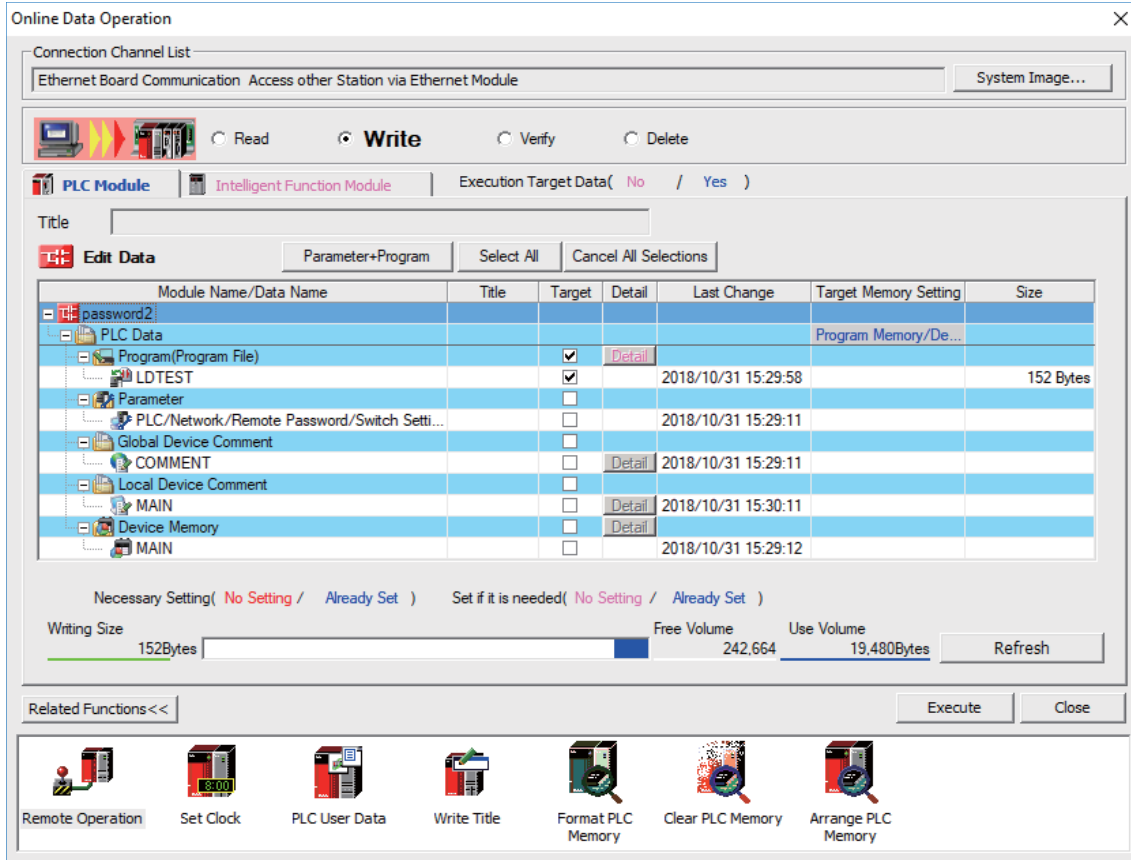

(2) Set [Target Memory Setting], select a file to store, and click [Execute].

(3) When writing is completed, close the "Online Data Operation" screen.

(4) Select [Online] - [Password/Keyword] - [New] to open the following "Create/Change Password" screen.

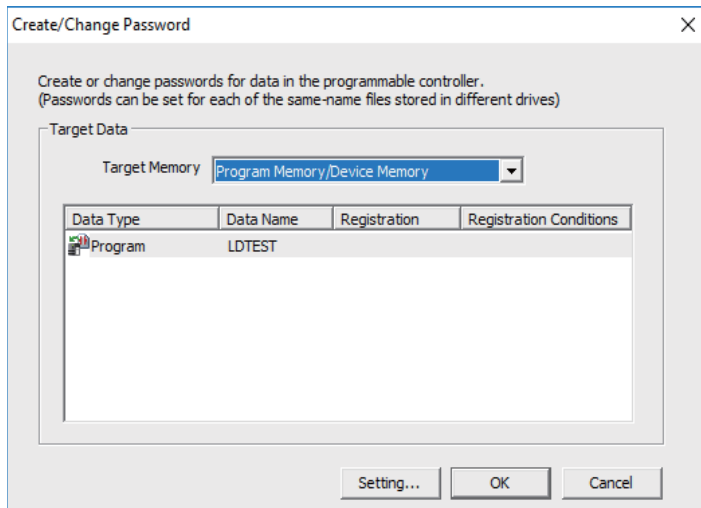

- (5) Select data area storing the file to be protected with password in [Target Memory], file list is displayed. Select the target file from the file list, click [Setting...].
Multiple files can be selected by clicking them while pressing [Ctrl]. The same password can be registered in a batch.
- (6) On the displayed "Input Password" screen, select [Registration Condition], input 4 one-byte alphanumeric characters (case sensitive) in the New Password field and Re-enter Password field.
Click [OK] after inputting them.

Input Password

Create password for the selected file.

After setting a password for PLC in the PLC, the password is required when reading PLC on the PLC, or writing to the PLC.

Registration Condition
Read/Write Protection

New Password

Re-enter Password

Explanation of Registration Conditions
[Registration Conditions] Write protection, Read/Write protection
[Valid Characters] 4 single-byte characters, numeric characters, alphabets A-Z, a-z can be used. Passwords are case-sensitive.

OK Cancel

- (7) Click [OK] on the "Create/Change Password" screen. When the following dialog is displayed, registration is complete.
To save password registration status of the sequence programs after CNC restart, execute [Online] - [Export to ROM Format].

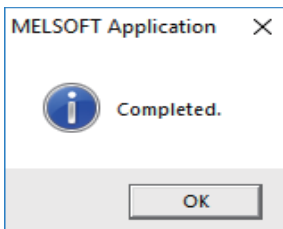

5.12.7.2 Changing File Passwords

Change passwords as follows.

In this example, the password setting file is already stored in the CNC.

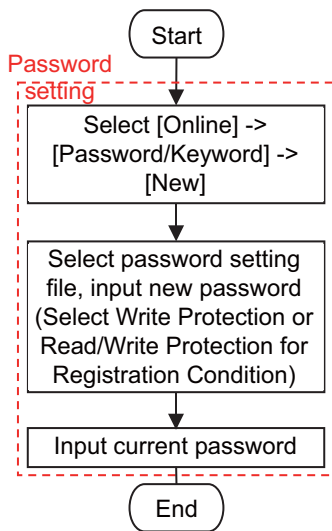

- (1) Select [Online] - [Password/Keyword] - [New], open the following "Create/Change Password" screen.

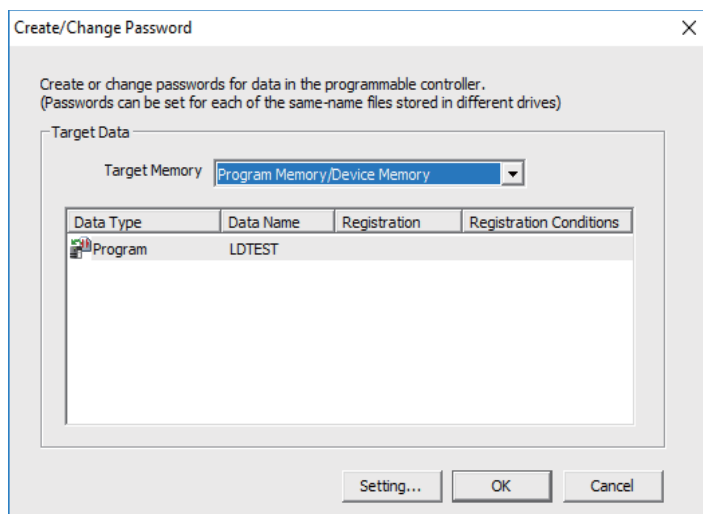

- (2) Select the data area storing the file password to be changed in [Target Memory] to display the file list. Select a desired file from the file list, and click [Setting...].
Multiple files can be selected by clicking files while pressing [Ctrl]. The same password can be registered in a batch.

- (3) Select [Registration Condition] on the displayed "Input Password" screen, input the password after change that is 4 one-byte alphanumeric characters long (case sensitive) in the "New Password" field and "Re-enter Password" field. Click [OK] after input.

- (4) When the following "Disable Password" screen is displayed, input the password before change and click [OK].

- (5) Click [OK] on the "Create/Change Password" screen. When the following dialog is displayed, change is completed. To save the changed password of sequence programs after CNC restart, execute [Online] - [Export to ROM Format].

5.12.7.3 Clearing File Password

The following flowchart shows the procedure of clearing a file password.

In this example, the password setting file is already stored in the CNC.

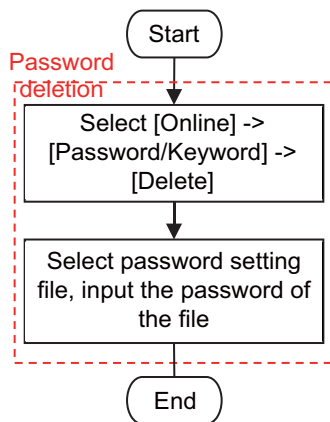

- (1) Select [Online] - [Password/Keyword] - [Delete] to open the following "Delete Password" screen.

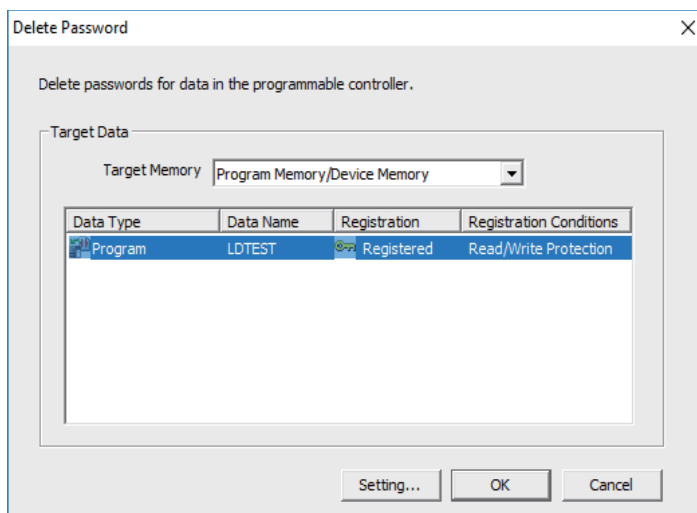

- (2) Select the data area storing the file to delete password for as [Target Memory] to display a file list. Select a desired file from the file list, and click [Setting...].
Multiple files can be selected by clicking them while pressing [Ctrl]. If the files share the same password, password can be deleted in a batch.

- (3) When the following "Input Disable Password" screen is displayed, input the password for the file, and click [OK].

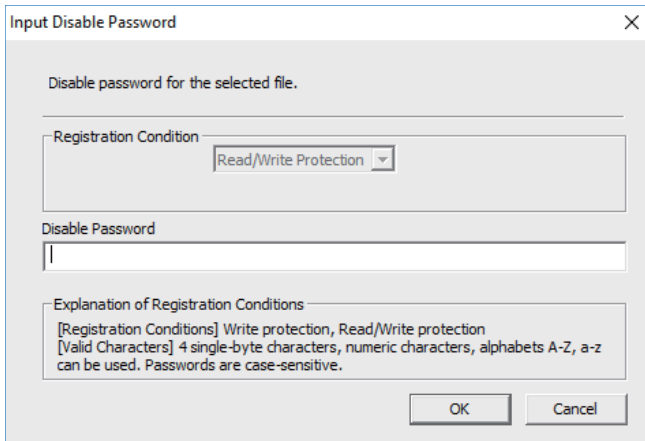

The screenshot shows a dialog box titled "Input Disable Password" with a close button (X) in the top right corner. The main text reads "Disable password for the selected file." Below this, there is a "Registration Condition" section with a dropdown menu currently set to "Read/Write Protection". Underneath is a "Disable Password" text input field. At the bottom, there is an "Explanation of Registration Conditions" section containing the following text: "[Registration Conditions] Write protection, Read/Write protection" and "[Valid Characters] 4 single-byte characters, numeric characters, alphabets A-Z, a-z can be used. Passwords are case-sensitive." At the very bottom of the dialog are two buttons: "OK" and "Cancel".

- (4) Click [OK] on the "Delete Password" screen. When the following dialog is displayed, deletion is completed. Execute [Online] - [Export to ROM Format] to retain the state, which the password of the sequence program has been deleted, even after CNC is restarted.

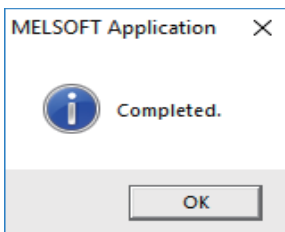

5.12.7.4 Temporary Unlock of File Password

To work with a password-protected file on GX Works2 for the following operations, temporarily unlock the file password. The temporary unlock of a file password is achieved by inputting the registered file password for verification and temporarily disable unlock for file operation. If the password verification fails, you cannot operate the file.

For instance, when read-protecting a program file with password on a certain session of GX Works2, and then reading from PLC on another session of GX Works2, temporarily unlock the file password by verifying it.

Temporary password unlock is valid only in the GX Works2 program on which the file password is unlocked. To work with a file on a separately started session of GX Works2, temporarily unlock the file password again.

Temporary password unlock is valid until the GX Works2 program in which the file password was unlocked is ended.

Operation on GX Works2	Unlock password required/not required
[Online] -> [Read from PLC] [Online] -> [Verify with PLC]	When a file password to prohibit read is set, the password needs to be temporarily unlocked.
[Online] -> [Write to PLC] [Online] -> [Delete PLC data]	When file password for Read/Write Protection or Write Protection is set, temporary password unlock is required.

A file password is temporarily unlocked as follows.

In this example, the password setting file is already stored in the CNC.

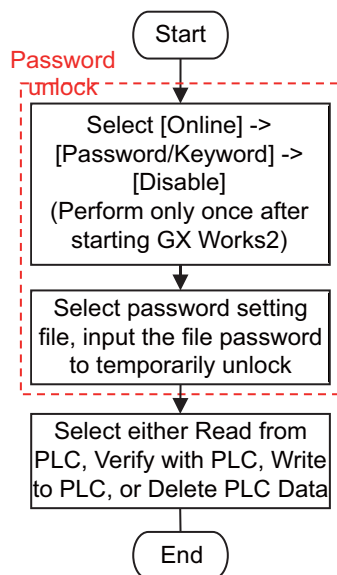

- (1) Select [Online] - [Password/Keyword] - [Disable] to open the "Disable Password" screen below.

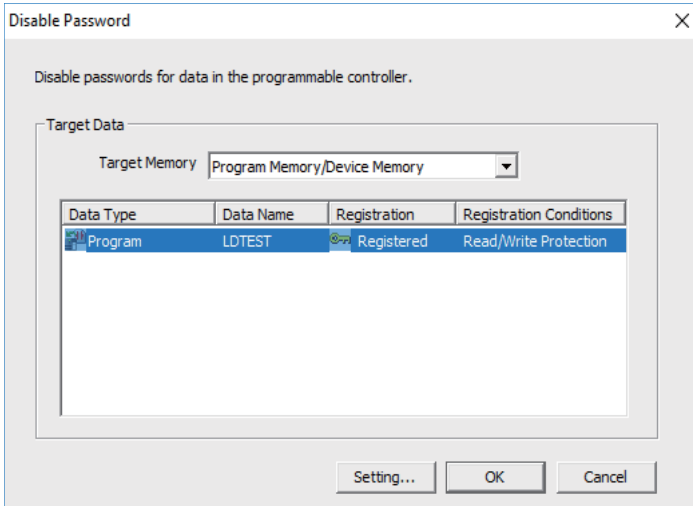

- (2) Select data area storing the desired file for temporarily password unlock in [Target Memory] to display a file list. Select the target file from the file list, and click [Setting...].

Multiple files can be selected by clicking them while pressing [Ctrl]. If the files share the same password, passwords can be unlocked in a batch.

- (3) When the following "Input Disable Password" screen is displayed, input the password for the file, and click [OK].

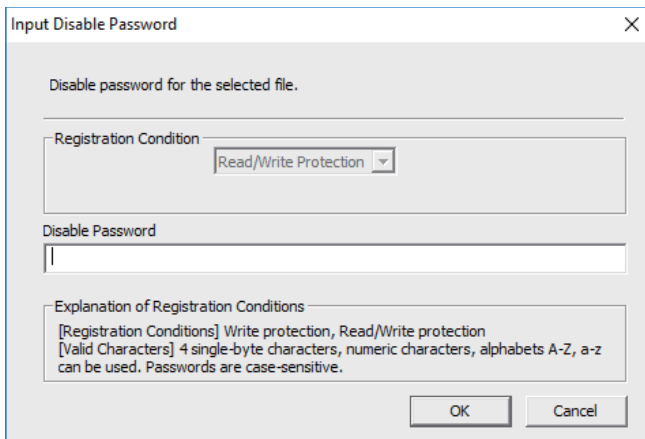

- (4) Click [OK] on the "Disable Password" screen. When the following dialog is displayed, temporary unlock is completed.

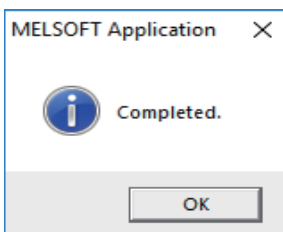

5.13 Corrective Actions to Resolve Errors

5.13.1 List of Errors during GX Works2 Online Operation

When an error is generated on GX Works2, the following dialog is displayed. The dialog displays error messages and error status. Note that error status inappropriate for CNC may be displayed since some displayed error messages are meant for MELSEC PLC. Status is displayed as the last 4 digits of the display number.

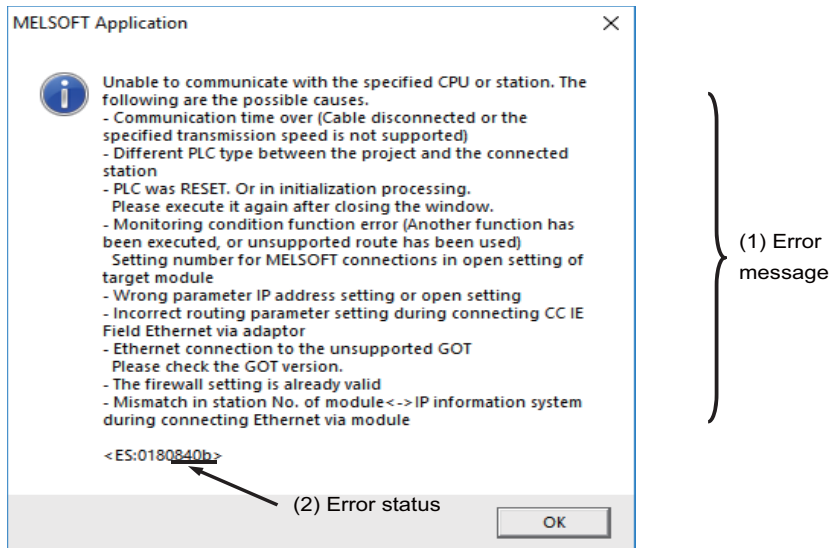

CAUTION

When an error is generated in GX Works2 online function, error messages may not represent the error status of the CNC controller correctly. Refer to the following error list.

The following table shows the cause and remedy of errors generated during online operation with CNC controllers.

For information on other errors, refer to "Help of GX Works2".

(*) Interpret the "PLC" in the messages to "CNC controller".

Status	Message	Cause	Remedy
2056	The executed function is not supported. Please check the manual and other documentation.	The writing during RUN function was executed.	Do not execute the writing during RUN function.
4001 4002	The executed function is not supported. Please check the manual and other documentation.	An operation not supported by the specifications was attempted.	Check the operation procedures.
4005	Writing of data which exceeds the capacity of the PLC was attempted. Execute again within the capacity of the PLC.	The maximum number of steps that can be executed with NC has been exceeded.	Check the size of execution area. (Refer to "5.6.4.4 Other Operations and Checks on Error", "5.7.4.4 Other Operations and Checks on Error") Reduce the number of steps for the relevant sequence program to be executed with reference that value.
4010	Cannot write because the PLC is executing a RUN command. Stop the PLC, then execute again.	The PLC of the NC is running.	After stopping the PLC of the NC, start execution again.
4021	The applicable drive is not ready. Check the applicable drive, then execute again.	The specified target memory does not exist or is not in a usable status.	Change the target memory.
4022	A file which does not exist in the PLC was specified.	Ladder program writing during RUN was attempted to nonexistent sequence program.	Check the editing program whether it exists in NC or not.

Status	Message	Cause	Remedy
4024	The executed function is not supported. Please check the manual and other documentation.	<ul style="list-style-type: none"> Writing unavailable files (files except sequence program, comment, message, and parameters) was conducted. Writing to the file created by structured project was executed. 	<ul style="list-style-type: none"> Check the operating procedures. Check the project type of the file to be written.
4025	Processing is in progress from another peripheral device. Please wait until the other processing is completed, then execute again.	Multiple peripheral development tools (Built-in PLC edit function/GX Works2) were accessed to the same file.	Wait for completion of access from other peripheral development tool, then execute again.
4029	Insufficient file capacity. Execute again after deleting unnecessary files.	An attempt was made to write a file that exceeds the storage capacity.	Examine the file structure so that the data falls within the limited capacity.
4031	The specified device No. exceeds the permissible range. Specify a device No. that is within the range set in the parameter.	<ul style="list-style-type: none"> The access request given is outside the accessible device range. "Device memory" was written by "Write to PLC" function. 	<ul style="list-style-type: none"> Check the number range of each device. Remove the check mark of "Device memory", and then execute "Write to PLC" function again.
4052	The file is write protected. Change the file attributes to enable writing to the file.	The specified target memory is a write-disabled device (internal ROM).	Specify "Program memory/Device memory" as the target memory.
4065	A mismatch occurred between the PLC and peripheral parameters. Match the parameters between the PLC and peripherals.	There is a problem in the device setting value.	Set the number of device points. (Refer to "5.5.8 Setting the Parameters")
4070	The program before correction differs from the registered program.	<ul style="list-style-type: none"> In writing into PLC, an unspecified sequence instruction is included in the program. In ladder program writing during RUN, the program before the modification does not match with the one in the NC. 	<ul style="list-style-type: none"> Verify the program and specify the instruction which has caused the error. Check whether the target program is the same as the running one in the NC. Check the device setting in PC parameter as well.
4080	Factor and Treatment <ul style="list-style-type: none"> Write both the parameter and program file to the CPU module because it might make an error of CPU if only the programs were written to the CPU module. Please check this function in the manual because the data specifying is mistake. 	When executing "Read from PLC" or "Verify PLC" function: Data not included in the specifications was found in the designated file.	The sequence program or message data in the CNC controller may be damaged. Delete the corresponding file and start again, or initialize the PLC data storage area. If the problem cannot be resolved, contact the Mitsubishi Electric System Department.
		When executing "Write to PLC": Multiple END instructions were found in the designated sequence program file.	Edit the sequence program in the list mode to delete END instructions except only one at the last line.
41c5	Selected operation could not be performed. The following are possible causes. <ul style="list-style-type: none"> Symbolic information data does not exist. Symbolic information data is corrupted. 	Files which are not stored in NC were written/read.	Press "Refresh view" button on write/read menu to update the file list.
8008	An unusable port or IP address was specified, or the number of settable connections for MELSOFT exceeded its maximum. Please execute again after checking the following settings. <ul style="list-style-type: none"> Port/IP address setting Setting number for MELSOFT connections in open setting of target module IP address duplication on network 	The Ethernet setting on the GX Works2 is incorrect.	Check the Ethernet setting, or check the cable connection.
8201	Cannot communicate with the specified CPU or station. The following are possible causes. Please review the manual. <ul style="list-style-type: none"> Cable trouble. (bad connection, a break) PLC power is off or in reset state. The hardware failure of power module, CPU module, I/O module, Intelligent module, Network module, base unit or extension cable. 	The serial communication cable is faulty. <ul style="list-style-type: none"> Not connected DTR signal off 	Check the serial port setting and cable connection.

Status	Message	Cause	Remedy
8301	<p>Cannot communicate with the specified CPU or station. Execute again after checking the connections with the PLC. For Ethernet connection, please check the following settings.</p> <ul style="list-style-type: none"> ♦ Port/IP address setting ♦ Setting number for MELSOFT connections in open setting of target module ♦ IP address duplication on network 	<p>There was no response from the NC connected with Ethernet.</p>	<p>Check the following:</p> <ul style="list-style-type: none"> ♦ CNC status ♦ Cable connection ♦ Ethernet address setting ♦ Inhibiting GX Developer/GX works2 connection setting
840b	<p>Cannot communicate with the specified CPU or station. The following are the possible causes.</p> <ul style="list-style-type: none"> ♦ Communication time over (Cable disconnected or the specified transmission speed is not supported) ♦ Mismatch between PLC types for project and connected station ♦ RESET of PLC Please execute it again after closing the window. ♦ Monitoring condition function error (Another function has been executed, or unsupported route has been used) ♦ Setting number for MELSOFT connections in open setting of target module ♦ Wrong parameter IP address setting or open setting ♦ Incorrect routing parameter setting during connecting CC IE Field Ethernet via adaptor ♦ Ethernet connection to the unsupported GOT ♦ Please check the GOT version. 	<p>There is no response from the NC.</p> <ul style="list-style-type: none"> ♦ The CNC has not started properly. ♦ The connection channel of the CNC side serial port is different. ♦ The serial cable outside the specifications is used for signal connection. ♦ An incorrect Ethernet address is set on the NC side 	<p>Check the following.</p> <ul style="list-style-type: none"> ♦ CNC status ♦ Cable connection ♦ Bit selection: GPP communication valid ♦ Set the Ethernet address

5.13.2 Checking PLC Alarms on CNC Controller

When an error is generated while sequence programs is starting up or being executed, the status is in user PLC alarm state.

The details of the alarm can be checked by one of three methods:

- ♦ Alarm screen on the setting and display unit of the CNC controller
- ♦ PLC diagnosis screen of built-in PLC edit function
- ♦ PLC diagnosis screen of GX Works2

The PLC diagnosis screen of GX Works2 provides information as clearly as the alarm screen on the setting and display unit of the CNC controller, and also displays ladders in which errors occurred.

5.13.2.1 Operation Procedure

(1) Start the "PLC Diagnostics" screen on GX Works2 by the following operation.

[Diagnostics] -> [PLC diagnostics]

(2) The following screen is displayed. Error information is displayed in (a) and (b).

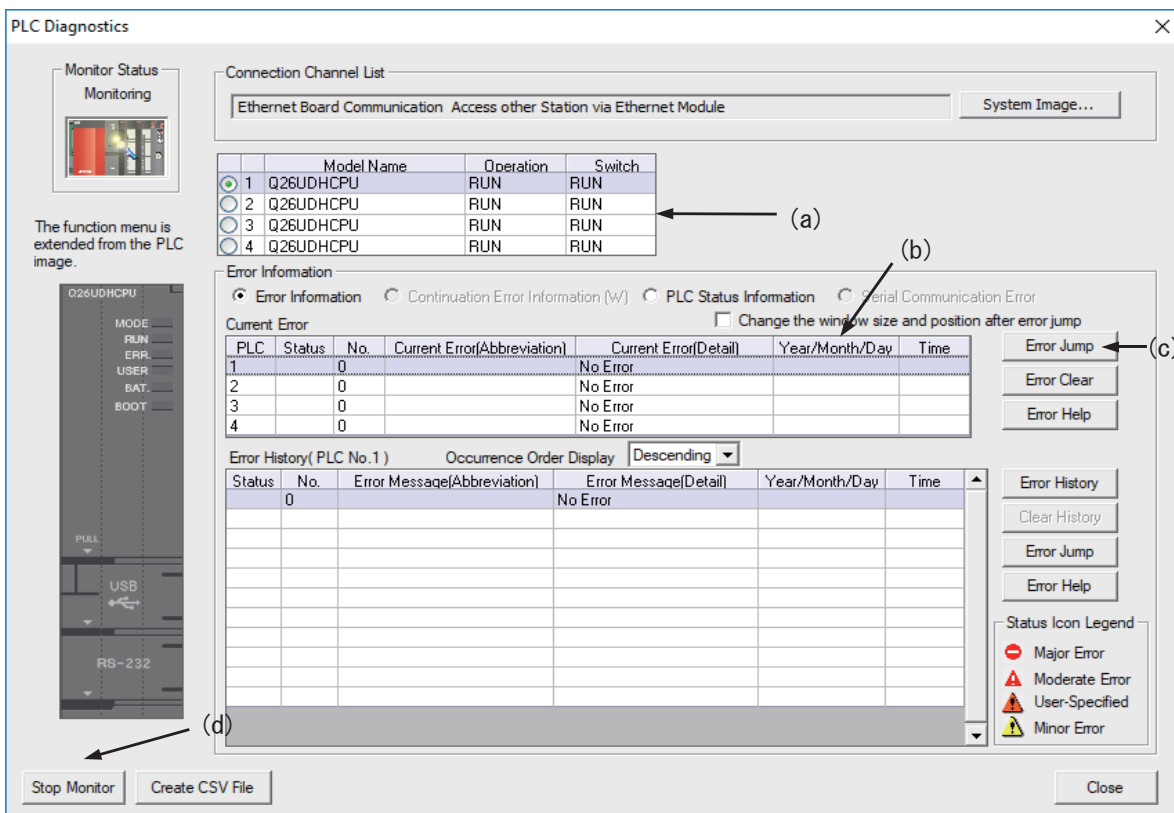

- (a) CPU operating status: RUN/STOP status of PLC is displayed here.
- (b) Error information: Error No. and error occurrence time are displayed here.
 - If there is no error, "No error" is displayed
 - Error No. is the high-order 2 digits of the CNC side alarm sub status1
 - Further detail is available upon double-click. (described later)
 - When the multi-project is enabled, different CPU modules are displayed depending on the project where the error is generated.
- (c) Error jump button: Displays ladders in which errors occurred. (described later)
- (d) Error display, start monitor and stop monitor button: Stops error information monitoring.

Note

- ♦ Other displays and buttons than (a) to (d) above and [Close] are not supported.

5.13.2.2 Details on Error Information Display

Error information is generated and cleared according to the following rules.

- The latest error after PLC RUN is displayed until a new error is generated.
- Error display is cleared only when RUN is executed from PLC STOP.
- When multi-project is enabled and errors are generated in multiple projects, the error to be displayed is of the project that is the last in the order of project execution among projects with errors.
- The errors that were generated before the execution of PLC are displayed sequentially from project 1.
- Errors that are common to all projects (e.g. PLC system error) are displayed on CPU No.1.

Where the information of CPU module is displayed differs depending on the project where errors are generated, as shown below.

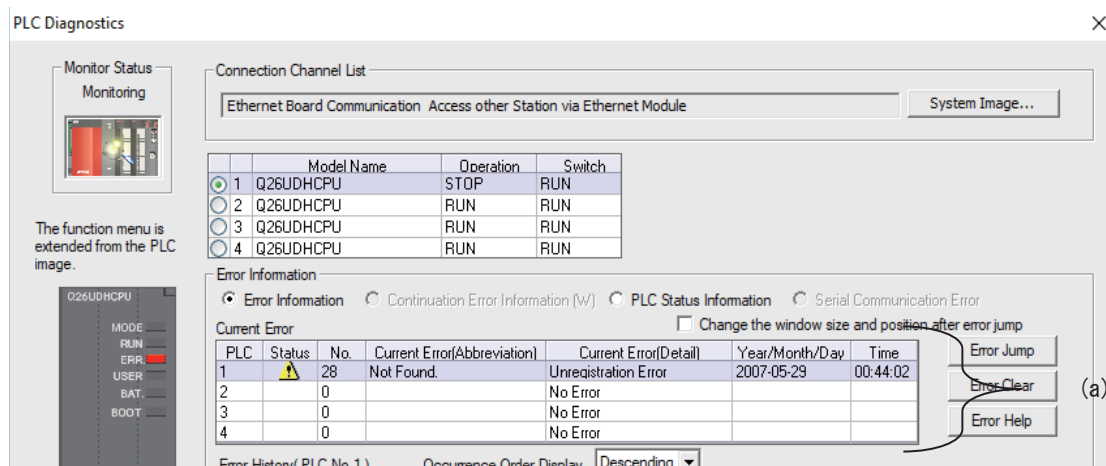

The position of CPU module display (a) changes depending on the project that GX Works2 is connected to.

- When connected to projects 1 to 4: Errors of project 1 to 4 are displayed in CPU 1 to CPU 4.
- When connected to projects 5 and 6: Errors of project 5 and 6 are displayed in CPU 1 to CPU 2.

5.13.2.3 Displaying Detailed Error Information

The detailed error information can be displayed on the "PLC Diagnostics" screen by the following operation.
 Double-click [(b) error information] on the "PLC Diagnostics" screen

The following "Error Details" screen is displayed.

(1) When the sequence program is responsible for the error

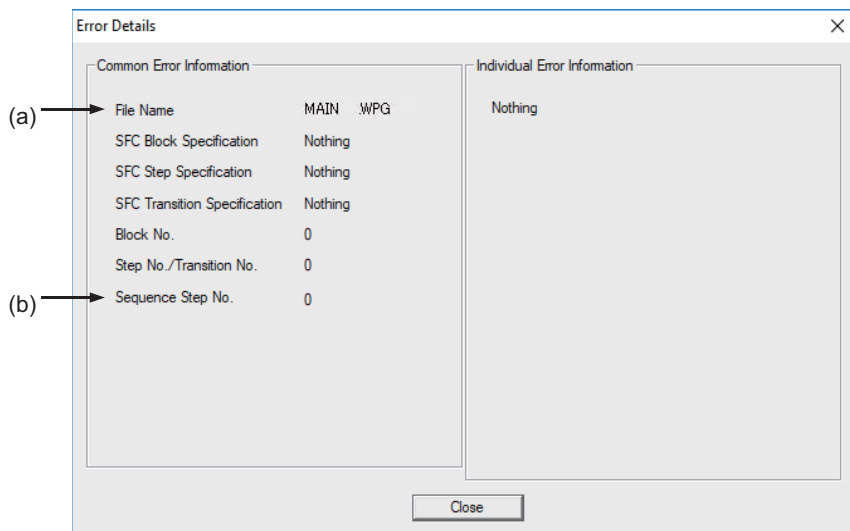

- (a) File name: Displays the file name of the sequence program where the error is generated.
- (b) Sequence step No.: Displays the step No. in which the error is generated in (a).

(2) When parameter setting is responsible for the error

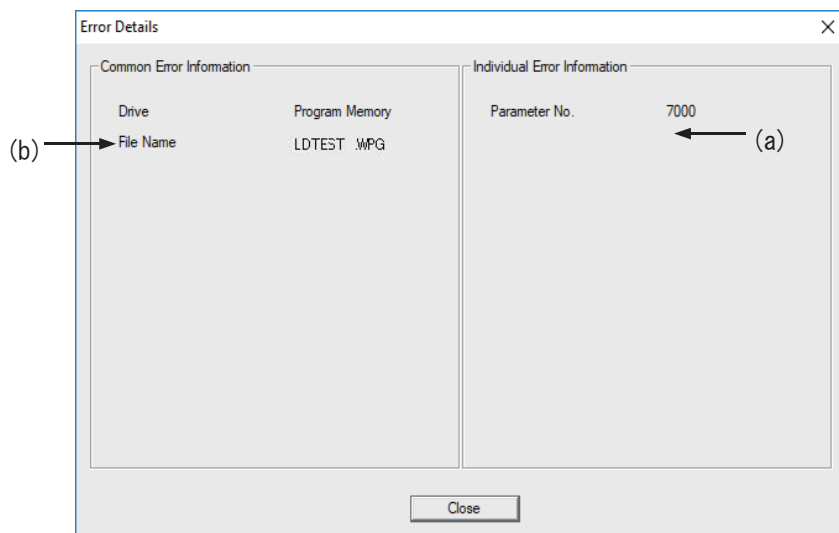

- (a) Parameter No.: Displays the parameter No. that has the wrong setting.
 1005: Common Pointer No.
 7000: Program setting
- (b) File name: Displays the name of the parameter setting file related to the error.

Note

(1) In (1) and (2) above, other displays than (a) and (b) have no meaning. The contents of (a) and (b) may not be displayed depending on the cause for an error.

5.13.2.4 Displaying of the Ladder in which an Error Occurred

The ladder in which an error has occurred is displayed on the "PLC Diagnostics" screen. By following the operations below, the ladder in which an error occurred which exists in the project currently opened with the GX Works2 can be displayed in the edit mode.

Click [Error Jump] (c) on the "PLC Diagnostics" screen

The ladder of the file in which an error has occurred is displayed on another window. Then the cursor moves to the step where the error has occurred.

The following conditions are required to accurately display the ladder in which an error occurred section.

- The file name and sequence program No. must be displayed in the "Error details" screen.
(In this case, no response or error dialog display will be given even if the button is clicked.)
- A project including the sequence program currently in operation in the CNC controller side must be opened.
(Even when a project not in operation is opened, if the same program name already exists, a ladder different from the actual one in which an error occurred is displayed. So, be careful.)
- Depending on the type of error, sequence step No. does not show the ladder in which an error occurred accurately.

5.13.3 Initializing PLC Data Storage Area

Initialize temporary storage of the CNC controller and redo from the beginning if any of the following conditions applies. This initialization operation does not initialize the ROM in the CNC. To retain redone status after the power OFF, it needs to be stored in the ROM in the CNC.

- ♦ When an error is generated during write to the CNC controller
- ♦ When return is not possible even after remedy for the error is performed
- ♦ When stored data are erased at once

Initialization operation initializes the following area and data.

For details on PLC data storage area, see “5.5.3 PLC Data Storage Area”.

Target data	Target memory	Target area
Sequence programs Parameters	Program memory/device memory	Sequence program storage area/Temporary storage (RAM in CNC)
PLC messages Device comments Symbolic information (*1)	Program memory/device memory Memory card (RAM)	Data storage area/Storage area (ROM in CNC)

(*1) Files written to CNC when simple projects (with labels) or structured projects are used.

5.13.3.1 Operation Procedure

(1) Start the operation screen by the following operation on GX Works2.

[Online] -> [PLC Memory Operation] -> [Format PLC Memory]

(2) Click [Execute] on the following screen.

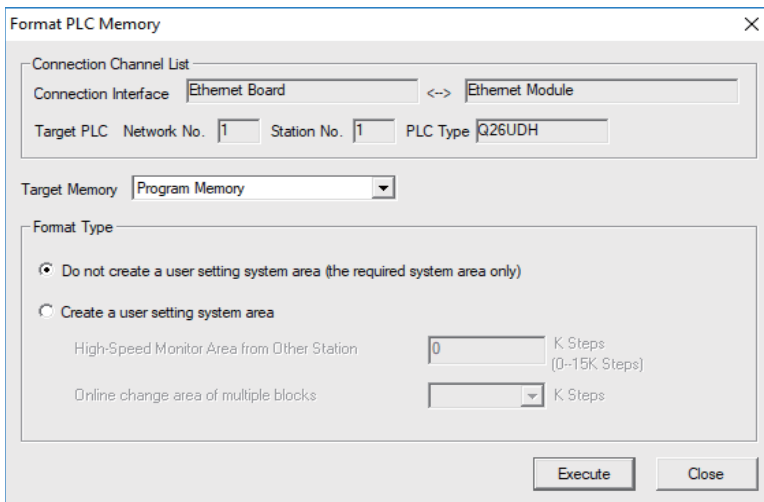

Note

- ♦ [Program Memory/Device Memory] is the only valid option for [Target Memory]. [Format Type] does not must be set.

(3) The operation is completed when the following dialog appears. Click [OK].

The data stored in the area selected in Target Memory are all deleted and initialized.

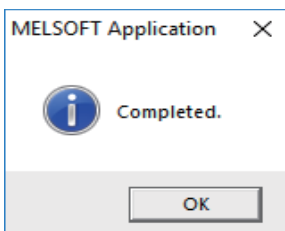

5.14 Backing Up Sequence Programs and Other Data

This section explains the methods for backing up the developed sequence programs and PLC related data in a personal computer.

5.14.1 Backup of Entire PLC-related Data

This section describes how to back up entire PLC-related data.

When the multi-project function is active, data for all projects are backed up in a batch.

5.14.1.1 Backup Target Data

The following data can be backed up.

	Related data type	Remark
(1)	Sequence programs	Sequence programs code
(2)	Parameter	Execution order setting information, etc.
(3)	Sequence programs comment	GX Works2 comment data
(4)	Message	Message data such as alarm messages, operator messages and PLC switches in each language
(5)	Multi-project setting parameters	Multi-project function setting information

5.14.1.2 Backup Procedures

Backup is executed on the input/output screen of the CNC controller.

Back up sequence programs stored in the ROM in the CNC to the personal computer by selecting the transfer symbolic information (CNC controller side) and the transfer target information (personal computer side) on the input/output screen and transferring the data.

This subsection describes the input/output screen example and operating procedure.

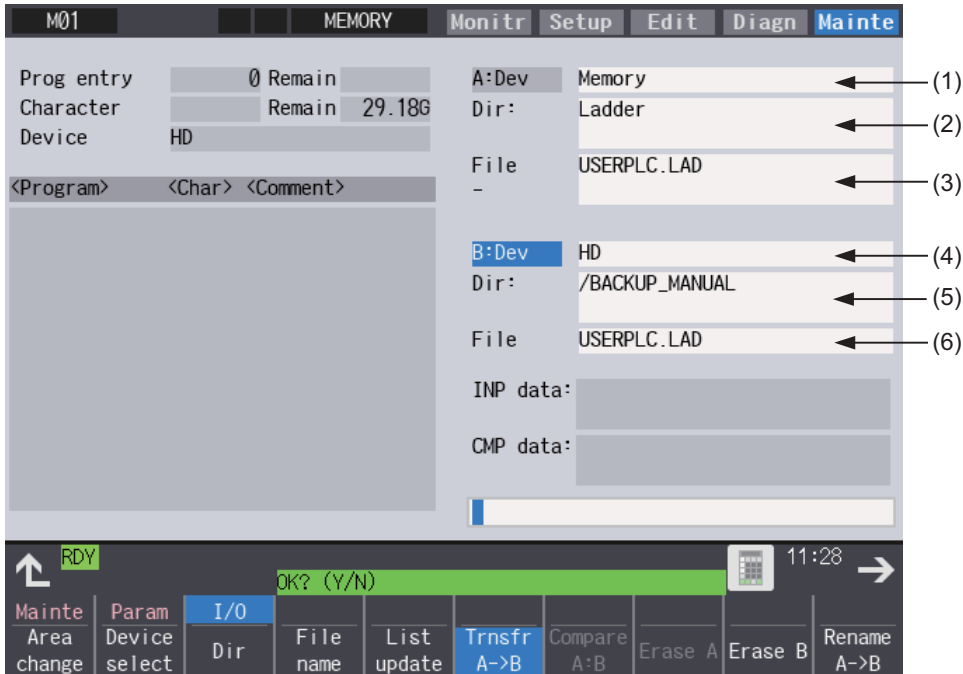

For details on the input/output screen, refer to the instruction manual for your model.

Setting for the CNC controller

Set the device name, directory, and file name for [A:Dev].

- (1) Set [A:Dev]
Select "Memory" with menu keys.
- (2) Set [Dir:]
Input the character string "/LAD".
- (3) Set [File]
"USERPLC.LAD" is automatically set when [Dir:] is set.
For the user safety sequence, input "SAFEPLC1.LAD" or "SAFEPLC2.LAD".

Setting for the personal computer (device name, directory, and file name)

Set the device name, directory, and file name for [B:Dev].

- (4) Set [B:Dev]
Select "HD" with menu keys.
- (5) Set [Dir:]
Input the character string "/".
- (6) Set [File]
Set the file name to be stored. When omitted, [USERPLC.LAD] is assigned.

Transmission

The backup process starts when the menu key [Trnsfr A->B] is pressed.

5.14.1.3 Backup Data Restoration

To restore backup data, perform the reversed backup operation (Enter the setting for the personal computer in [A:Dev], and the setting for CNC controller in [B:Dev]).

The PLC must be STOP before restoration is started.

5.14.1.4 Precautions

Precautions for input/output between different NC models or between systems with different additional specification status

If the large capacity PLC (256 kilo steps)/large capacity PLC (512 kilo steps) additional specification is enabled, the size of sequence programs that can be stored in CNC is increased.

USERPLC.LAD output while Large PLC capacity (256 kilo steps)/Large PLC capacity (512 kilo steps) additional specification is enabled may not be input to the system in which the enabling/disabling of Large PLC capacity option is switched, depending on the size of the sequence programs stored when output.

[Large capacity PLC additional specification, type of input USERPLC.LAD, and operation]

	Inputting USERPLC.LAD that was output when it contained more than 256 kilo steps sequence programs.	Inputting "USERPLC.LAD" that was output when the following was true: 128 kilo steps < Number of contained sequence program steps ≤ 256 kilo steps
Large capacity PLC additional specification is disabled in M800V series	The error "Can't write file for dev B" is generated.	The error "Can't write file for dev B" is generated.
Large capacity PLC (256 kilo steps) additional specification is enabled in M800V series	The error "Can't write file for dev B" is generated.	Writing and PLC execution is possible.
Large capacity PLC (512 kilo steps) additional specification is enabled in M800V series	Writing and PLC execution is possible.	Writing and PLC execution is possible.

When the PLC project extension (3 projects)/PLC project extension (6 projects) (additional specification) is enabled, the number of projects and device points that can be used increases when the multi-project function is active.

The USERPLC.LAD output while the PLC project extension (3 projects)/PLC project extension (6 projects) (additional specification) is enabled may not be input to the system whose PLC project extension option is switched between enabling/disabling, depending on the number of projects and device points set at the time of the output of USERPLC.LAD file.

[PLC project extension additional specification, type of input "USERPLC.LAD", and operation 1]

	Inputting "USERPLC.LAD" that was output when the maximum project No. was set to 4 or larger	Inputting "USERPLC.LAD" that was output when the maximum project No. was set to 2 or 3
PLC project extension additional specification is disabled in M800V series	The error "Can't write file for dev B" is generated.	The error "Can't write file for dev B" is generated.
PLC project extension (3 projects) additional specification is disabled in M800V series	The error "Can't write file for dev B" is generated.	Writing and PLC execution is possible.
PLC project extension (6 projects) additional specification is disabled in M800V series	Writing and PLC execution is possible.	Writing and PLC execution is possible.

[PLC project extension additional specification, type of input "USERPLC.LAD", and operation 2]

	Inputting "USERPLC.LAD" that was output when a number which was larger than the standard (*1) was set as the number of device points.
PLC project extension additional specification is disabled in M800V series	The error "Can't write file for dev B" is generated.
PLC project extension (3 projects) additional specification is disabled in M800V series	The error "Can't write file for dev B" is generated.
PLC project extension (6 projects) additional specification is disabled in M800V series	Writing and PLC execution is possible.

(*1) The size of standard device points and extended device points is as follows.

(The number shown below is the total number of points set in all projects.)

Device	Device points (standard)		Device	Device points (extended)
M	61440		M	122880
L	1024		L	2048
F	2048		F	4096
SB	1024		SB	2048
B	57344		B	114688
SM	6144		SM	12288
V	256		V	1024
SW	1024		SW	2048
SD	6144		SD	12288
T	2048		T	4096
ST	128		ST	256
C	512		C	1024
D	4096		D	8192
W	12288		W	24576
Z	60		Z	120
N	48		N	96
P	12288		P	24576

Precautions for inputting or outputting to or from CNC of different version

Do not store data written to the CNC on GX Works2 in a system of D1 or an earlier version.

5.14.2 Batch Backup of PLC-Related Data for Each Project

This section describes how to back up PLC-related data in batch for each project when the multi-project function is active.

5.14.2.1 Backup Target Data

The following data can be backed up.

Only the data of the project that is specified at backup is output.

	Related data type	Remark
(1)	Sequence programs	Sequence programs code
(2)	Parameter	Execution order setting information, etc.
(3)	Sequence programs comment	GX Works2 comment data
(4)	Message	Message data such as alarm messages, operator messages and PLC switches in each language
(5)	Multi-project setting parameters (Device points settings only)	Setting information for multi-project function Device points setting information
(6)	Symbolic information	Information on labels, FB, structures

5.14.2.2 Backup Procedure

Backup is executed on the input/output screen of the CNC controller.

Select the transfer symbolic information (CNC controller side) and the transfer target information (personal computer side), to be transferred on the input/output screen. When transmission is started, the data such as sequence programs of the specified project stored in the CNC ROM will be backed up in the personal computer.

An example of the input/output screen and the operating procedure are described below.

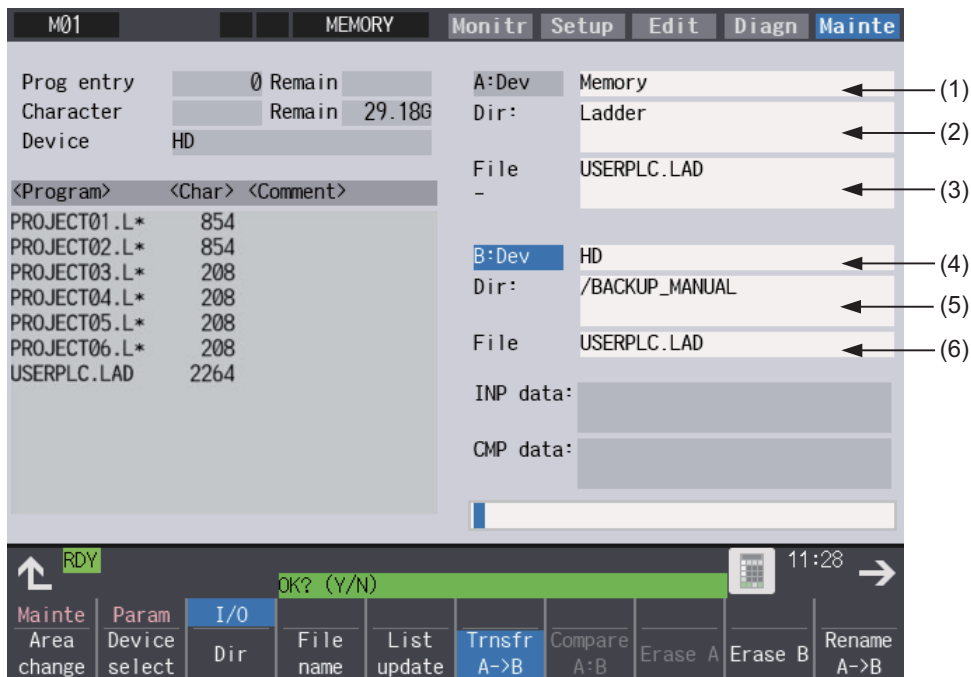

For details on the input/output screen, refer to the instruction manual of your model.

Setting for the CNC controller

Set the device name, directory, and file name for [A:Dev].

- (1) Set [A:Dev]
Select "Memory" with menu keys.
- (2) Set [Dir:]
Input the character string "/LAD".
- (3) Set [File]
Select [From list] with menu keys and select "PROJECTxx.LAD" (xx: project number to be output) from the file list, and press [INPUT].

Setting for the personal computer (device name, directory, and file name)

Set the device name, directory, and file name for [B:Dev].

- (4) Set [B:Dev]
Select "HD" with menu keys.
- (5) Set [Dir:]
Input the character string "/".
- (6) Set [File]
Set the file name to be stored. When omitted, "PROJECTxx.LAD" (xx: project number to be output) is assigned.

Transmission

The backup process starts when the menu key [Trnsfr A->B] is pressed.

5.14.2.3 Backup Data Restoration

To restore backup data, perform the reversed backup operation (Enter the setting for the personal computer in [A:Dev], and the setting for CNC controller in [B:Dev]).

The PLC must be STOP before restoration is started.

5.14.2.4 Precautions

Considerations for input/output with the conditions in the CNC

The backup data for each project (PROJECTxx.LAD) may not be input depending on the status in the CNC such as stored sequence programs, and data size.

This section describes the causes and remedies for the issues where backup for each project data (PROJECTxx.LAD) cannot be input.

Causes and remedies for when backup data for each project cannot be input

Causes	Error details	Remedy
Exceeds the device size that can be used in all projects	The data size has exceeded the available device size.	The size of empty/vacant/reserved device is not sufficient. Correct the multi-project parameter (device points) to increase empty/vacant/reserved size.
An attempt to input the data to unavailable project.	Input has been attempted for an unavailable project.	Input the data to an available project.
Size of data to input is greater than the storage area.	Data to input is too large.	Correct the multi-project parameter (project percentage) to increase the storage area size to be greater than the PLC data (sequence program and comment) of the project-based backup data.

Precautions for inputting or outputting to or from CNC of different version

Do not store data written to the CNC on GX Works2 in a system of D1 or an earlier version.

5.15 Project Protection Function

Project protection function prevents unauthorized users from changing GX Works2 projects, sequence programs in a CNC, etc. without permission.

This section explains how to protect projects without using the file password function.

5.15.1 Project Protection Function of GX Works2

The table below shows the protection functions of GX Works2 which are supported by Mitsubishi Electric CNC. For details of the file password function, refer to "5.12 File Password Function". Since the other protection functions of GX Works2 do not have exclusive specifications for Mitsubishi Electric CNC, refer to "GX Works2 Operating Manual (Common)" and "GX Works2 Operating Manual (Simple Project)" for detailed information of these functions.

[List of project protection function]

◎ : Supported; × : Not supported

Function	Machine sequence	User safety sequence	Remarks
Security	◎	◎	
Soft security key	×	×	
Block password settings	◎	◎	(*1)(*2)
Remote password settings	×	×	
File password	◎	◎	

(*1) After FB which has a block password and sequence program which has a function are written to the CNC, when the sequence program is read with the simple project (without labels), the area where the block password is set is read as an actual ladder (ladder with labels and functional block compiled). To read a ladder with labels and functional blocks, set a file password.

(*2) Symbols that can be used in a block password are as follows:

! " # \$ % & ' () * + , - . / : ; < = > ? @ [\] ~

Do not use the symbols "@", "^", "'", and "|" because they may not be input with PLC on-board although they can be set with GX Works2.

5.15.2 Project Protection Function of CNC

Parameters related to project protection

Startup of PLC on-board and connection from GX Developer or GX Works2 can be restricted by setting the following parameters. This prevents unauthorized users from changing or deleting sequence programs of built-in PLC, etc.

Parameter	Item	Details	Setting value
#6451 bit0	PLC on-board enabled	Starts-up the PLC on-board by pressing "F0" key.	0: Disabled
#11094	GX Restriction	Select whether to block the connection from GX Developer/GX Works2.	1: Block the connection

[Mainte] - [Protect setting] screen

A password can be changed on the protection setting screen of the CNC displayed by selecting [Mainte] - [Protect setting]. This prevents users who are not informed of the password from changing parameter settings and starting up the PLC on-board.

For details, refer to "Connection and Setup Manual".

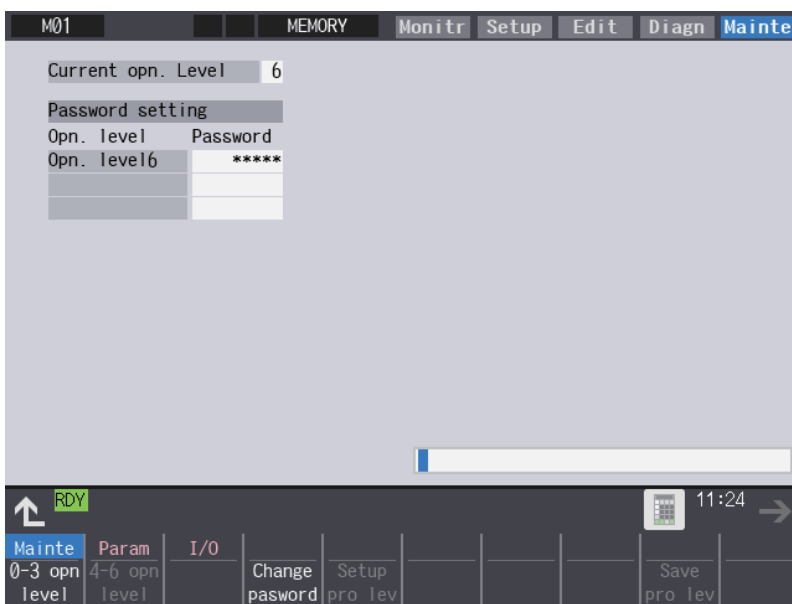

5.16 Displaying Project Verification Result in Ladder Diagram (GX Works3)

In GX Works2, the result of project verification can be displayed in instruction for each step.

By reading projects created by GX Works2 to GX Works3, verification result can be displayed in ladder diagram.

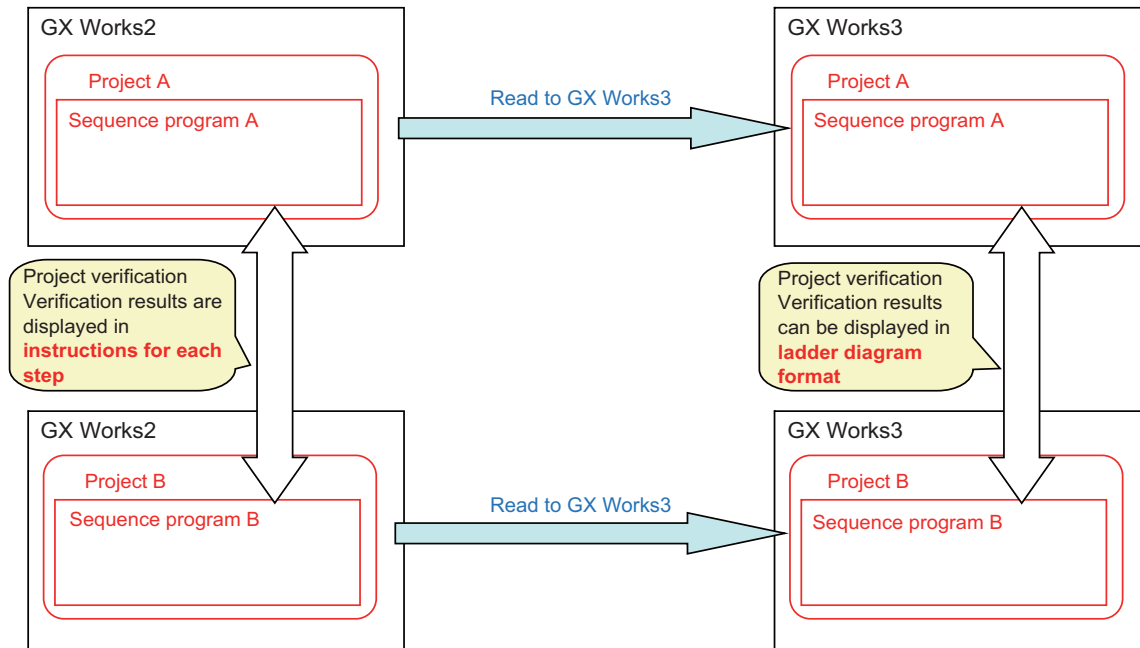

5.16.1 Operation Procedure

- (1) Save two GX Works2 project data that are the verification targets.
- (2) On GX Works3, read the GX Works2 project data that are the verification targets by the following operation.
Select [Project] - [Open Other Format File] - [GX Works2 Format] - [Open Project].

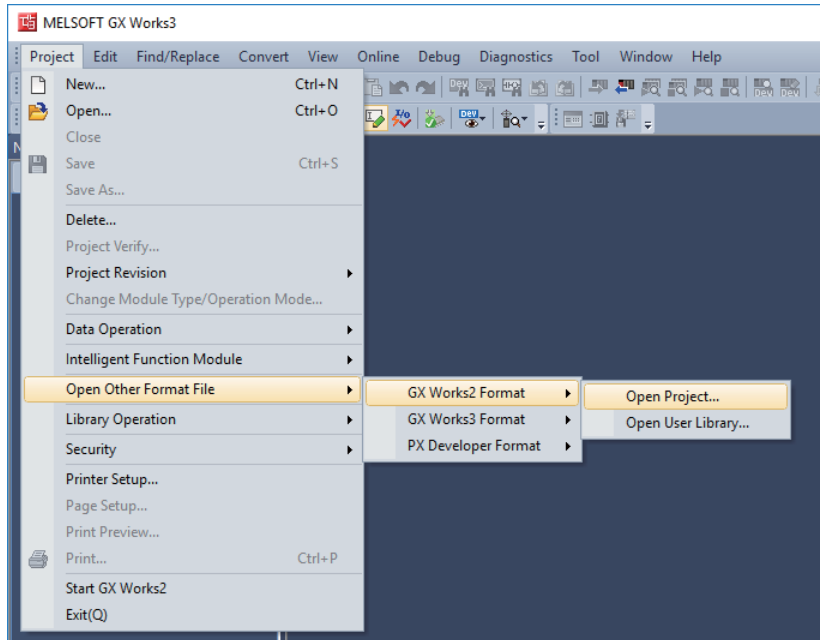

Select GX Works2 project data that is the verification targets.

Click [OK] in the dialog to confirm the change.

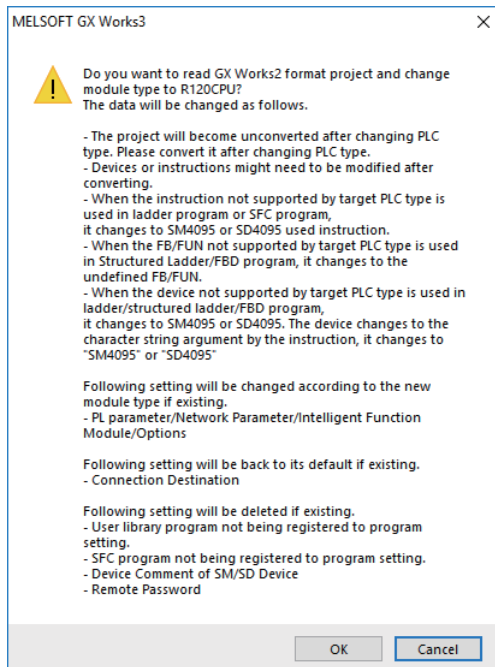

5 Peripheral Development Environment (GX Works2)

5.16 Displaying Project Verification Result in Ladder Diagram (GX Works3)

(3) Execute [Convert] - [Convert], and save the project.

When you convert the project with labels set, the following procedures are required before conversion.

- (a) Select [Parameter] - [C120CPU] - [CPU Parameter] on the "Navigation" window.
- (b) Select [Memory/Device Setting] - [Device/Label Memory Area Setting] on the "Setting Item List".
- (c) Select [Device/Label Memory Area Capacity Setting] - [Label Area] - [Label Memory Area Capacity], and set a value larger than "0 K" to this item.

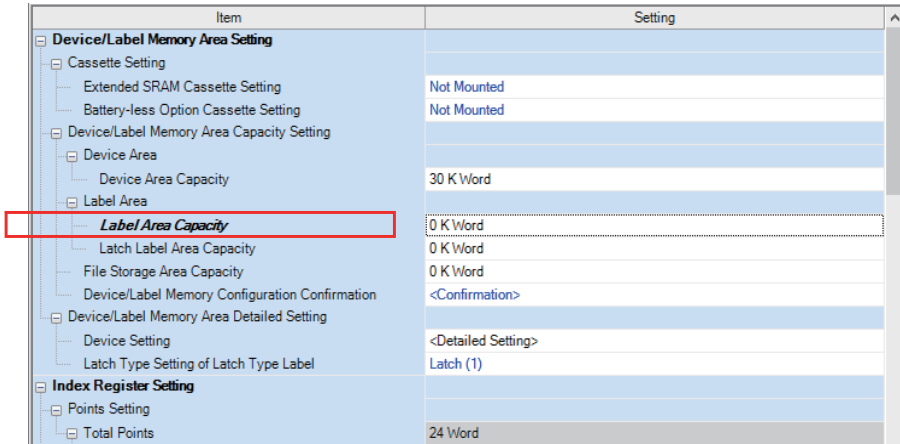

(4) The second project data can also be opened by the operations (2) and (3).

(5) Open [Project] - [Project Verify] on the other project of the verification targets.

(6) Set the other project in [Verify Destination], and click [Verify].

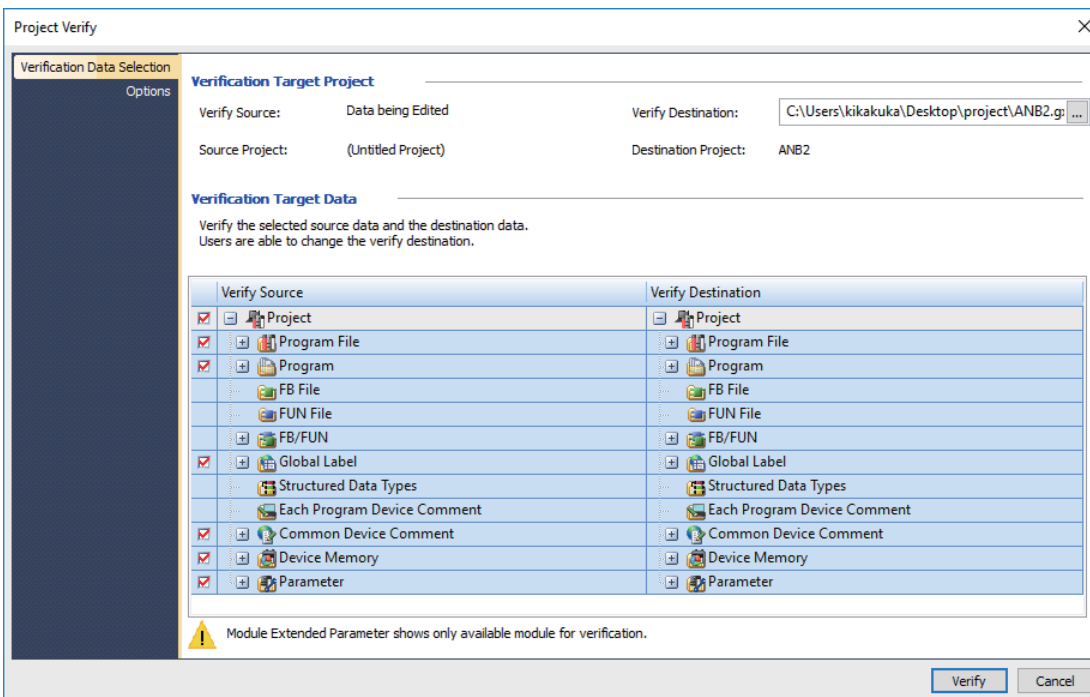

5 Peripheral Development Environment (GX Works2)

5.16 Displaying Project Verification Result in Ladder Diagram (GX Works3)

- (7) Double-click [Program] to be displayed in a ladder diagram from [Result List].
(Note that it is not [Program File].)

No.	Type	Data Name(Verify Source)	Data Name(Verify Destination)	Verification Result	Caution
1	Program File	MAIN	MAIN	Mismatch	
2	Program	MAIN	MAIN	Mismatch	
3	Program(Local Label)	MAIN	MAIN	Match	
4	Global Label	Global	Global	Match	
5	Common Device Comment	COMMENT	COMMENT	Match	
6	Device Memory	MAIN	MAIN	Match	
7	Parameter	System Parameter	System Parameter	Match	
8	Parameter	CPU Parameter	CPU Parameter	Match	
9	Parameter	CPU Module Parameter	CPU Module Parameter	Match	
10	Parameter	Module parameter	Module parameter	Match	

- (8) Verification result is displayed in ladder diagram.
Mismatched places are indicated in red, places existing only in verification source are indicated in blue, and places existing only in verification target are indicated in green.

[Example of ladder program]

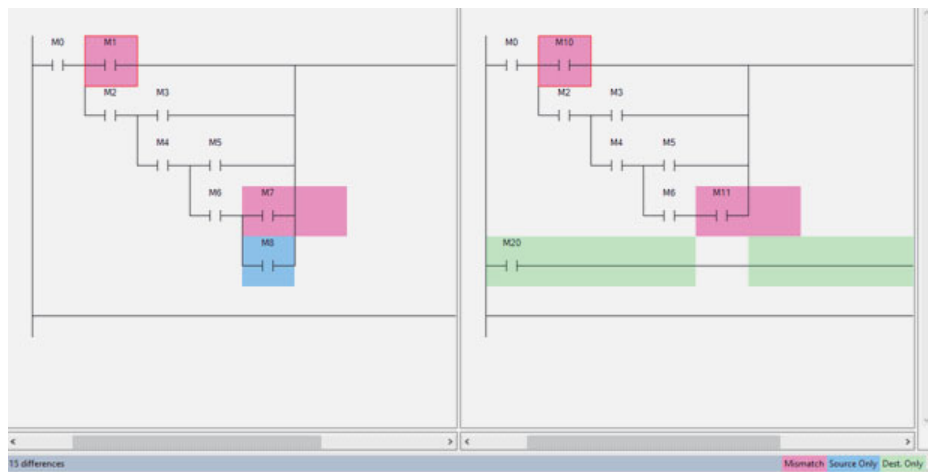

[Example of ST language]

```

1 intV2 := ABS(intV1);
2 intV3 := intV2;
3
4
5 IF M1 THEN
6   btn01 := TRUE;
7 ELSE
8   btn01 := FALSE;
9 END_IF;
10
11 IF btn01 = TRUE THEN
12   btn02 := TRUE;
13 END_IF;
    
```

5.17 Restrictions

5.17.1 Restrictions in Comparison with MELSEC PLC

5.17.1.1 Overall Restrictions

Restrictions	Related item
Sequence programs and ST language can be used. ST language can be selected when a simple project (with labels) or a structured project is selected. Inline ST, SFC language, or structured ladder cannot be used.	5.2.1 Support Status of Project Types, Program Types and POU's
Only up to seven ANB instructions and ORB instructions can be used consecutively. When FB is used, hours of use become unclear.	5.6.3 Developing Sequence Programs
Only up to seven MPS instructions can be used consecutively. When MPP instruction is used, one more MPS instruction becomes available. When FB is used, hours of use become unclear.	5.6.3 Developing Sequence Programs
When a sequence program with more than 211 contacts is written to the CNC controller on GX Works, it may not be displayed correctly by built-in edit functions.	5.17.4 Built-in PLC (Built-In Edit Function)
When [Sampling Trace] - [Write to PLC] is used, only trace setting is written, and trace result is not written on the CNC controller.	5.5.11 Sampling Trace of Device
When the capacity of [memory card (SRAM)] is calculated by [Tool] - [memory capacity calculation], a dialog is displayed. The displayed calculation result is not affected.	5.5 Common Items

5.17.1.2 Restrictions on Simple Projects (with Labels)

Restrictions	Related item
In a sequence program, FB can be nested in another FB; however, the nesting depth is limited to one level. In a ST language program, FBs can be nested up to four levels deep.	5.2.1 Support Status of Project Types, Program Types and POU's 5.6 Developing Simple Project 5.11.4 Restrictions
When symbolic information is written to CNC, sequence programs cannot be edited by built-in edit function.	5.17.4 Built-in PLC (Built-In Edit Function)

5.17.1.3 Restrictions on Structured Projects

Restrictions	Related item
In a ladder program, FB can be nested in another FB; however, the nesting depth is limited to one level. In a ST language program, macro type FBs can be nested up to four levels deep, and subroutine type FBs can be nested up to fifteen levels deep.	5.2.1 Support Status of Project Types, Program Types and POU's 5.7 Developing Structured Project 5.11.4 Restrictions
When symbolic information is written to CNC, sequence programs cannot be edited by built-in edit function.	5.17.4 Built-in PLC (Built-In Edit Function)

5.17.2 Differences from GX Developer

Considerations	Related item
GX Works2 has no macro functions. Use FB.	5.11 Creating Function Block
Device names cannot be set for devices in GX Works2. Use the label function. When symbols (e.g. +, -) that cannot be used in labels are required, use two-byte symbols.	5.10.3 Writing Method of Indirect Input
Sequence programs cannot be displayed as a list in GX Works2.	5.2.1 Support Status of Project Types, Program Types and POU's
The CNC controller does not support the "conversion" + "writing during RUN" function of GX Works2.	5.6.8 Executing Ladder Program Writing during RUN
Passwords are set only for the CNC controller programs, and not for GX Works2 programs.	5.12 File Password Function
When a program with a password stored in the CNC controller is read to GX Works2, password information is not read.	5.12.6 File Password: Cautions on Setting
Passwords for files cannot be set while IC memory card image data is being written in GX Works2.	5.14 Backing Up Sequence Programs and Other Data
Inputting/outputting methods for text data such as PLC messages or device comments are different; - GX Developer uses SJIS while GX Works uses UNICODE. - GX Developer uses the term "comma/fixed length delimiter" while GX Works uses the term "tab delimiter". - GX Developer and GX Works have different header formats	5.8 PLC Message Development 5.9 Creating Device Comment 5.10 Creating Label
While trace execution is in progress, trace result cannot be read or displayed.	5.5.11 Sampling Trace of Device
CSV output formats of trace data are different between GX Works2 and GX Developer. Output formats cannot be selected in GX Works2.	5.5.11 Sampling Trace of Device
ST language is supported only by GX Works2. CNC does not support the creation and edition of an ST language by GX Developer.	-
In GX Developer, when an attempt is made to write sequence programs without writing parameters on the "Write to PLC" screen during PLC RUN, the message "Do you want to write to PLC after remote stop?" is displayed. In GX Works2, When an attempt is made to write sequence programs without writing parameters on the "Write to PLC" screen during PLC RUN, the message "PLC is running. Do you want to force write of the files?" is displayed. If [Yes] is clicked, an error dialog is displayed and sequence programs are not written. If [No] is clicked, "Do you want to write to PLC after remote stop?" is displayed.	5.5.6 Writing Data to CNC Controller 5.6.4 Writing the Sequence Program to the CNC Controller

5.17.3 Multi-language Data

5.17.3.1 Creating Multi-language Data

To create PLC messages and device comments in a specific language, perform the following steps.

Note that GX Works2 supports only Japanese, English, Chinese (Simplified Chinese characters), Chinese (traditional Chinese characters), and Korean.

Other languages cannot be used in creating PLC messages and device comments.

(1) Install the preferred language version of Windows OS

Install the Windows OS that supports the preferred language on the machine.

(2) Set Windows display language

Change the display language of Windows OS to the preferred language from [Control Panel] - [Languages] on Windows.

Usually the default setting does not need to be changed.

(3) Set GX Works2 language

Open GX Works2, and select the preferred language from [Tool] - [Language Selection].

(4) Create PLC messages and device comments, and write them to CNC

For details on how to create and write PLC messages to CNC, see chapter 5.8.

For details on how to create and write device comments to CNC, see chapter 5.9.

Note

- When handling PLC messages and device comments in a specific language, ensure that the language of the OS, the display language of the OS, and GX Works2 language are all the same.

5.17.3.2 Using Multi-language Data

To use GX Developer format projects containing PLC messages and device comments created in a specific language on GX Works2, configure the setting according to the procedure (1) to (3) in "5.17.3.1 Creating Multi-language Data", and then perform the procedure described in "5.5.10.1 Reading Sequence Programs in GX Developer Format on GX Works2".

Note that GX Works2 supports only Japanese, English, Chinese (Simplified Chinese characters), Chinese (traditional Chinese characters), and Korean.

PLC messages and device comments created in other languages cannot be used.

5.17.4 Built-in PLC (Built-In Edit Function)

To use built-in PLC (built-in edit function) to edit the sequence programs created and edited on GX Works2, the following restrictions must be taken into account.

■ Overall restrictions

When a sequence program containing more than 11 contacts is written to the CNC controller, the built-in edit function may display it incorrectly.

■ Restrictions when creating programs with labels

When a program is created after simple project (with labels) is selected on GX Works2, built-in PLC (built-in edit function) does not display labels and function blocks, and display the actual ladder (ladder with labels and functional blocks complied) to which actual device is assigned.

Since symbolic information cannot be modified by built-in PLC (built-in edit function), when sequence programs are read to GX Works2 again after editing, symbolic information and sequence program do not match, resulting in the following error. Do not edit sequence programs with the built-in edit function when writing symbolic information.

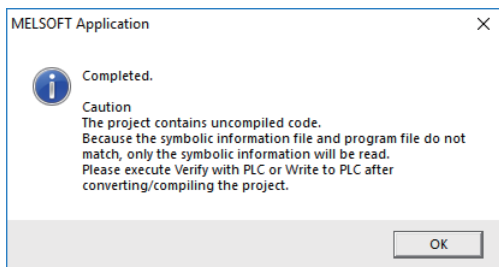

Note that the built-in PLC (built-in edit function) does not support ST language. Edit programs using ST language with GX Works2.

5.17.5 Smart Safety Observation

User safety sequence program can be created with GX Works2.

For the smart safety observation function, refer to "M800/M80 Series Smart safety observation Specification manual".

5.17.6 Enhanced PLC Security Mode

When enhanced PLC security mode is enabled on a CNC, some functions of GX Works2 which communicate with the CNC are restricted.

For details on the enhanced PLC security mode, refer to "9.1 Enhanced PLC Security Mode".

5.18 Troubleshooting and FAQ

#	Item	Details
1	Problem	When sequence programs in the GX Developer format are read to GX Works2, symbolic information, PLC message, and device comment cannot be written to the CNC controller.
	Scenario	When the setting for writing symbolic information in the [Symbolic Information] option under [Tool] -> [Options] on GX Works2 is [High Speed Mode], symbolic information is written to CNC as two files. Note the symbolic information was written as one file if it is from GX Developer. If the number of files to be written to the data area is the maximum in GX Developer, when read to GX Works2, the number of files exceeds the maximum.
	Remedies	Select [Compatible mode] in the setting for writing symbolic information in the [Symbolic Information] option under [Tool] -> [Options] on GX Works2, and write to the NC.

Explanation of Built-in Editing Function (PLC On-board)

6.1 Outline

This chapter describes the PLC (built-in editing function) built into the Mitsubishi Electric CNC M8V Series products. For the terms used in this section, refer to "1 Definitions of Terms".

When this function is started on the NC system version D0 or later where "smart safety observation function (*1)" is enabled user safety sequence "SafePLC1" and "SafePLC2" are displayed in the project list on the main screen. Select the project or the user safety sequence to switch the operation target.

(*1) The function to achieve high safety on M800V series. For details, refer to "M800/M80 Series Smart safety observation Specification manual".

6.1.1 List of Project

Projects that can be used with PLC on-board are as follows:

A project that is stored in CNC		
Tool	Project type	Label
GX Developer	Simple project	Provided (*1)
		None
GX Works2 (*2)(*3)	Simple project	Provided (*4)
		None
	Structured project (*5)	-

(*1) Operates as a project without labels.

(*2) Supported only for M800VW series and M80VW series.

(*3) Some functions may be limited. Refer to the precautions of "6.1.2 List of Function" for details.

(*4) Some functions may be limited. Refer to the precautions of "6.9 Precautions when Using a Project with Labels" for details.

(*5) Some functions may be limited. Refer to the precautions of "6.10 Precautions when Using a Structured Project" for details.

6.1.2 List of Function

The on-board functions and function availability for each operation target are listed as follows.

■ For the machine sequence

Function	Purpose of function	Operation target	
		GX Developer project (without labels)	GX Works2 project
Ladder monitoring			
Monitor	This switches to the ladder monitor mode.	○	○
Entry Device Monitor	This monitors the ladder and the status of any registered devices simultaneously.	○	×
Entry Ladder Monitor	This monitors the ladder and any registered ladders simultaneously.	○	×
Register Monitor	This registers desired devices and ladders to the device registration monitor and the ladder registration monitor.	○	×
Registered Ladder All Delete	This deletes all the ladders registered in the entry ladder monitor.	○	×
Device Test	This turns the bit devices on/off and changes the current values of word devices.	○	○
Current Value Monitor Change-over (10/16)	This changes the display of the current device values on the ladder monitor between decimal and hexadecimal.	○	○
Block Password Disable	This disables the block password set in FB.	×	○
FB Instance Monitor	This displays the FB instance monitor in the circuit.	×	○
Ladder editing			
Edit	This changes to the ladder edit mode.	○	×
Insert Row	This inserts a blank line at the cursor position.	○	×
Delete Row	This deletes the line at the cursor position.	○	×
Mark	This selects the desired range of ladders.	○	×
Copy & paste	This copies the ladders in the selected range and pastes these ladders to the specified position.	○	×
Edit Ladder	This edits ladders.	○	×

6 Explanation of Built-in Editing Function (PLC On-board)

6.1 Outline

Function	Purpose of function	Operation target	
		GX Developer project (without labels)	GX Works2 project
Statement Edit	This edits statements.	○	×
Note Edit	This edits notes.	○	×
Convert Ladder	This converts edited circuits and enables them to be executed. The behavior is different according to the setting of ladder program write during RUN (#6455 bit6/bit7). [When ladder program writing during RUN is disabled] The conversion is done only when PLC is in STOP state. If PLC is running, the conversion will be done after PLC is stopped. [When ladder program writing during RUN is enabled] The conversion can be done when PLC is running or stopped.	○	×
Undo	This undoes the last edit operation.	○	×
Ladder searching			
FIND (Device, Instruction FIND)	This searches for specified devices, specified device contacts, and specified device coils.	○	○
Find FB Instance	This searches specified FB instance (FB instance name).	×	○
Finding Step Numbers	This searches specified step numbers.	○	○
Contact Coil Usage List	This displays the index position, usage status, and step number used by specified devices.	○	×
List of Used Devices	This displays the usage list for each device type as a batch.	○	×
Ladder display			
Comment Display Setting	This configures the display of comments, statements, notes, and device names.	○	○
Ladder Display	This sets the ladder display size and the maximum number of contacts for each line.	○	○
Switch Program	This changes the programs in the current display.	○	○
Zoom Display	This switches the ladder display size between three sizes.	○	○
	Reduced [Equivalent to a full-screen display of 11 contacts at 640 x 480 resolution]	○	○
	Standard [Equivalent to a full-screen display of 11 contacts at 1024 x 768 resolution]	○	○
	Enlarged (120%) [Equivalent to a full-screen display of 11 contacts at 1280 x 1024 resolution]	○	○
Comment ON/OFF	This switches the display of comments as configured by [COMMENT DISPLAY SETTING].	○	○
Monitor Value Display	This changes displays of the current value for the device on the ladder monitor between on/off.	○	○
Ladder checks			
CHECK PROGRAM	This checks programs (ladders).	○	×
PLC data operation			
Add New Data	This adds new PLC data.	○	×
Delete Data	This deletes PLC data.	○	×
Rename Data	This changes the name of PLC data.	○	×
Device operation			
Device Batch Monitor	This monitors from the specified device on one screen.	○	○
Entry Device Monitor	This monitors devices at separated positions in circuits or different types of devices simultaneously on one screen.	○	○
Sampling trace	This traces (data collection) PLC device signals and displays the trace result in chronological order. Also this saves the trace data to external media, and writes or reads the trace file for external media.	○	○ (Cannot be specified with label name)
Parameters			
Program Setting	This configures the execution order of sequence programs.	○	○ (Only confirmation of settings is available)
Device Setting	This configures the range of devices used in a project.	○	○
Common Pointer Setting	This enables confirmation of common pointer settings used in a project.	○	○

6 Explanation of Built-in Editing Function (PLC On-board)

6.1 Outline

Function	Purpose of function	Operation target	
		GX Developer project (without labels)	GX Works2 project
Multi-project Parameters	This configures parameters related to the operation of multiple projects.	○	○
NC file operation			
LIST	This displays PLC data in temporary memory and ROM.	○	○
Number of Execution Step Display	This displays the number of PLC data steps in execution area.	○	○
Amount of Free Space Display	This displays the amount of free space of temporary memory and ROM.	○	○
POU List	This displays the POU list in PLC data of temporary memory and ROM.	×	○
PLC data auto load	This automatically reads PLC data from temporary memory upon start-up.	○	○
Open	This displays the PLC data in temporary memory at the on-board editing area.	○	○
ROM Write	This saves the PLC data in temporary memory to ROM.	○	○
Format	This formats the temporary memory.	○	○
PLC RUN/STOP	This runs and stops the PLC.	○	○
Password Cancellation	This cancels the password set in PLC data.	○	○
PLC Version up	This rewrites the PLC data in the on-board editing area, temporary memory area and built-in ROM area with the version upgrade data on external media.	○	×
External File Operation			
External -> NC	This reads PLC data on external media into the NC and opens it on the on-board.	○	○
NC -> External	This saves NC PLC data to external media.	○	○
Delete Project	This deletes projects on external media.	○	×
Verify Project	This verifies NC PLC programs and PLC programs on external media.	○	×
Diagnosis			
PLC diagnosis	This displays errors that occur during program (ladder) execution.	○	×
Environment setting			
Connect NC changing	This switches CNC connected to the display unit.	○ (For Windows-based display only)	○ (For Windows-based display only)
Others			
Key/Touchscreen history	This records the information input with the key or the touchscreen. This is enabled only when the operation history function in the Mitsubishi Electric standard screen is enabled.	○	○

■ User safety sequence

Function	Purpose of function	Operation target	
		GX Developer user safety sequence (without labels)	GX Works2 user safety sequence
Ladder monitoring			
Monitor	This switches to the ladder monitor mode.	○	○ (FB and label can also be monitored)
Entry Device Monitor	This monitors the ladder and the status of any registered devices simultaneously.	○	×
Entry Ladder Monitor	This monitors the ladder and any registered ladders simultaneously.	○	×
Register Monitor	This registers desired devices and ladders to the device registration monitor and the ladder registration monitor.	○	×
Registered Ladder All Delete	This deletes all the ladders registered in the entry ladder monitor.	○	×
Device Test	This turns the bit devices on/off and changes the current values of word devices.	×	×
Current Value Monitor Change-over (10/16)	This changes the display of the current device values on the ladder monitor between decimal and hexadecimal.	○	○
Block Password Disable	This disables the block password set in FB.	×	○
FB Instance Monitor	This displays the FB instance monitor in the circuit.	×	○
Ladder editing			
Edit	This changes to the ladder edit mode.	×	×
Insert Row	This inserts a blank line at the cursor position.	×	×
Delete Row	This deletes the line at the cursor position.	×	×
Mark	This selects the desired range of ladders.	×	×
Copy & paste	This copies the ladders in the selected range and pastes these ladders to the specified position.	×	×
Edit Ladder	This edits ladders.	×	×
Statement Edit	This edits statements.	×	×
Note Edit	This edits notes.	×	×
Convert Ladder	This converts edited circuits and enables them to be executed. The behavior is different according to the setting of ladder program write during RUN (#6455 bit6/bit7). [When ladder program writing during RUN is disabled] The conversion is done only when PLC is in STOP state. If PLC is running, the conversion will be done after PLC is stopped. [When ladder program writing during RUN is enabled] The conversion can be done when PLC is running or stopped.	×	×
Undo	This undoes the last edit operation.	×	×
Ladder searching			
Find	This searches for specified devices, specified device contacts, and specified device coils.	○	○
Finding Step Numbers	This searches specified step numbers.	○	○
Contact Coil Usage List	This displays the index position, usage status, and step number used by specified devices.	○	×
List of Used Devices	This displays the usage list for each device type as a batch.	○	×
Ladder display			
Comment Display Setting	This configures the display of comments, statements, notes, and device names.	○	○
Ladder Display	This sets the ladder display size and the maximum number of contacts for each line.	○	○
Switch Program	This changes the programs in the current display.	×	×

6 Explanation of Built-in Editing Function (PLC On-board)

6.1 Outline

Function	Purpose of function	Operation target	
		GX Developer user safety sequence (without labels)	GX Works2 user safety sequence
Zoom Display	This switches the ladder display size between three sizes.	○	○
	Reduced [Equivalent to a full-screen display of 11 contacts at 640 x 480 resolution]	○	○
	Standard [Equivalent to a full-screen display of 11 contacts at 1024 x 768 resolution]	○	○
	Enlarged (120%) [Equivalent to a full-screen display of 11 contacts at 1280 x 1024 resolution]	○	○
Comment ON/OFF	This switches the display of comments as configured by [COMMENT DISPLAY SETTING].	○	○
Monitor Value Display	This changes displays of the current value for the device on the ladder monitor between on/off.	○	○
Ladder checks			
CHECK PROGRAM	This checks programs (ladders).	×	×
PLC data operation			
Add New Data	This adds new PLC data.	×	×
Delete Data	This deletes PLC data.	×	×
Rename Data	This changes the name of PLC data.	×	×
Device operation			
Device Batch Monitor	This monitors from the specified device on one screen.	○	○
Entry Device Monitor	This monitors devices at separated positions in circuits or different types of devices simultaneously on one screen.	○	○
Sampling trace	This traces (data collection) PLC device signals and displays the trace result in chronological order. Also this saves the trace data to external media, and writes or reads the trace file for external media.	○	○ (Cannot be specified with label name)
Parameters			
Program Setting	This configures the execution order of sequence programs.	×	×
Device setting	This configures the range of devices used in a project.	×	×
Common Pointer Setting	This enables confirmation of common pointer settings used in a project.	×	×
Multi-project Parameters	This configures parameters related to the operation of multiple projects.	×	×
NC file operation			
LIST	This displays PLC data in temporary memory and ROM.	○	○
Number of Execution Step Display	This displays the number of PLC data steps in execution area.	○	○
Amount of Free Space Display	This displays the amount of free space of temporary memory and ROM.	○	○
POU List	This displays the POU list in PLC data of temporary memory and ROM.	×	○
PLC data auto load	This automatically reads PLC data from temporary memory upon start-up.	○	○
Open	This displays the PLC data in temporary memory at the on-board editing area.	○	○
ROM Write	This saves the PLC data in temporary memory to ROM.	×	×
Format	This formats the temporary memory.	×	×
PLC RUN/STOP	This runs and stops the PLC.	×	×
Cancel Password	This cancels the password set in PLC data.	×	×
PLC Version up	This rewrites the PLC data in the on-board editing area, temporary memory area and built-in ROM area with the version upgrade data on external media.	×	×
External File Operation			
External -> NC	This reads PLC data on external media into the NC and opens it on the on-board.	×	×
NC -> External	This saves CNC PLC data to external media.	×	×
Delete Project	This deletes projects on external media.	×	×
Verify Project	This verifies NC PLC programs and PLC programs on external media.	×	×
Diagnosis			

6 Explanation of Built-in Editing Function (PLC On-board)

6.1 Outline

Function	Purpose of function	Operation target	
		GX Developer user safety sequence (without labels)	GX Works2 user safety sequence
PLC diagnosis	This displays errors that occur during program (ladder) execution.	x	x
Environment setting			
Connect NC changing	This switches CNC connected to the display unit.	○ (For Windows-based display only)	○ (For Windows-based display only)
Others			
Key/Touchscreen history	This records the information input with the key or the touchscreen. This is enabled only when the operation history function in the Mitsubishi Electric standard screen is enabled.	○	○

6.1.3 Operation Mode of Project

Operation mode settings

Use the bit selection parameters to set whether the project operated on the PLC on-board operates as a GX Developer project or a GX Works2 project.

Operation mode is allocated with bit selection parameter as follows: This parameter is enabled when the PLC on-board is restarted.

(1) For the machine sequence

Parameter	Bit	Item	Setting value
R7835-H(#6472)	bit0	Operation Mode of Project No.1	0: Operates as a GX Developer project 1: Operates as a GX Works2 project
	bit1	Operation Mode of Project No.2	
	bit2	Operation Mode of Project No.3	
	bit3	Operation Mode of Project No.4	
	bit4	Operation Mode of Project No.5	
	bit5	Operation Mode of Project No.6	
	bit6	Reserve	
	bit7	Reserve	

(2) User safety sequence

Parameter	Bit	Item	Setting value
R7835-L(#6471)	bit6	Safety PLC "SafePLC1" operation mode	0: Operates as a GX Developer project 1: Operates as a GX Works2 project
	bit7	Safety PLC "SafePLC2" operation mode	

Operation mode and readable project

The combination of the operation mode and readable project is as follows.

Operation mode	Project type	Reading of project	Remarks
GX Works2	GX Works2 Simple project Without labels	○	
	GX Works2 Simple project With labels	○	Operates as a project without labels when there is no symbolic information
	GX Works2 Structured project	○	Operates as a project without labels when there is no symbolic information
	GX Developer Without labels	○	Operates as GX Works2 project
	GX Developer With labels	× (*1)	Operates as a GX Works2 project without labels when there is no symbolic information
GX Developer	GX Works2 Simple project Without labels	○	Operates as a GX Developer project
	GX Works2 Simple project With labels	× (*1)	Operates as a GX Developer project without labels when there is no symbolic information
	GX Works2 Structured project	× (*1)	Operates as a GX Developer project without labels when there is no symbolic information
	GX Developer Without labels	○	
	GX Developer With labels	○	Operates as a project without labels

(*1) Readable when there is no symbolic information.

6.1.4 Language

Programming language is as follows:

The following describes whether to display a project in CNC with PLC on-board.

Refer to MELSEC PLC development tool (GX Developer) specifications manual for M800/M80 Series or "5 Peripheral Development Environment (GX Works2)" for a programming language that the CNC can operate.

GX Developer project and GX Works2 simple project without labels

The following table describes the programming language supported by GX Developer project and GX Works2 simple project without labels.

Language	Function	
	File List/POU List	Monitor ladder/Find ladder
Ladder	Display	Display
SFC	Not display	Not display

GX Works2 simple project with labels

The following table describes the programming language supported by GX Works2 simple project without labels.

Language	Function	
	File List/POU List	Monitor ladder/Find ladder
Ladder	Display	Display
ST	Display	Not display
SFC	Not display	Not display

GX Works2 structured project

The following table describes the programming language supported by GX Works2 structured project.

Language	Function	
	File List/POU List	Monitor ladder/Find ladder
Ladder	Display	Display
ST	Display	Not display
SFC	Not display	Not display
Structured ladder/FBD	Display	Not display

6.2 Screen Configuration

6.2.1 Type

The following three types of screens are used to configure the PLC On-board.

Full screen	This screen is used to display the entire screen.
Split screen	This screen splits the full screen into two areas and displays.
Popup screen	This screen is displayed over the full screen display or split screen.
Message screen	This screen displays confirmation messages, error messages, and other messages.

The following diagrams illustrate examples of these screens. The area inside the blue lines in each diagram represents the screen.

[Full screen]

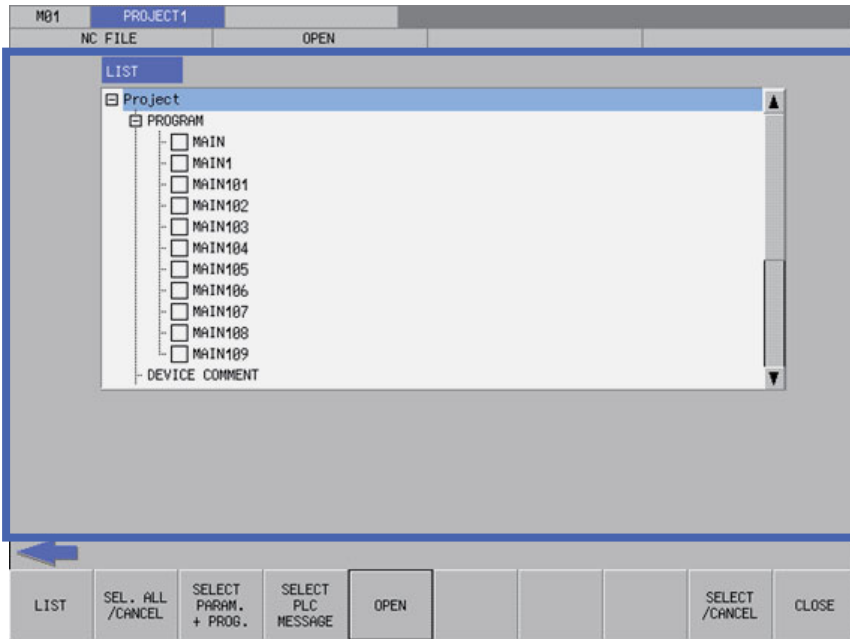

[Split screen]

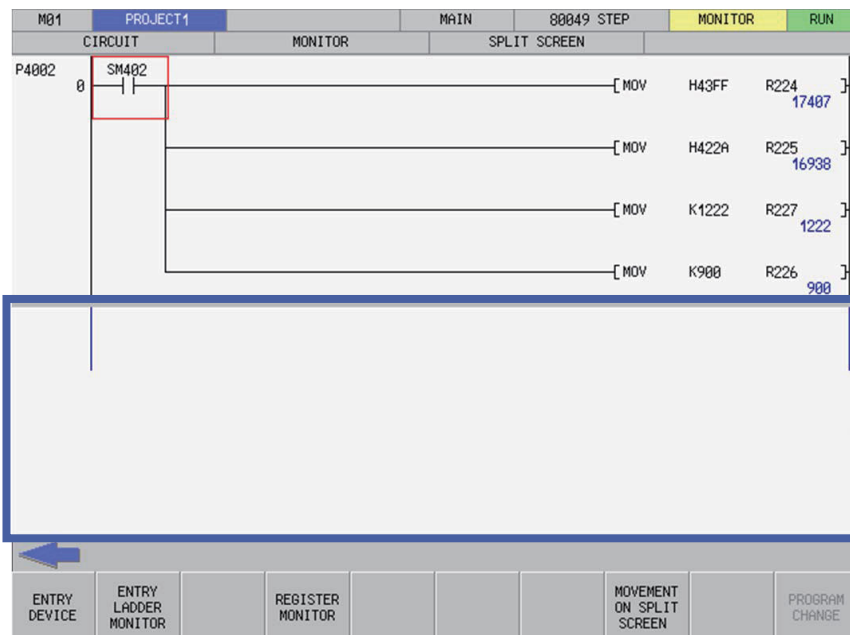

[Popup screen]

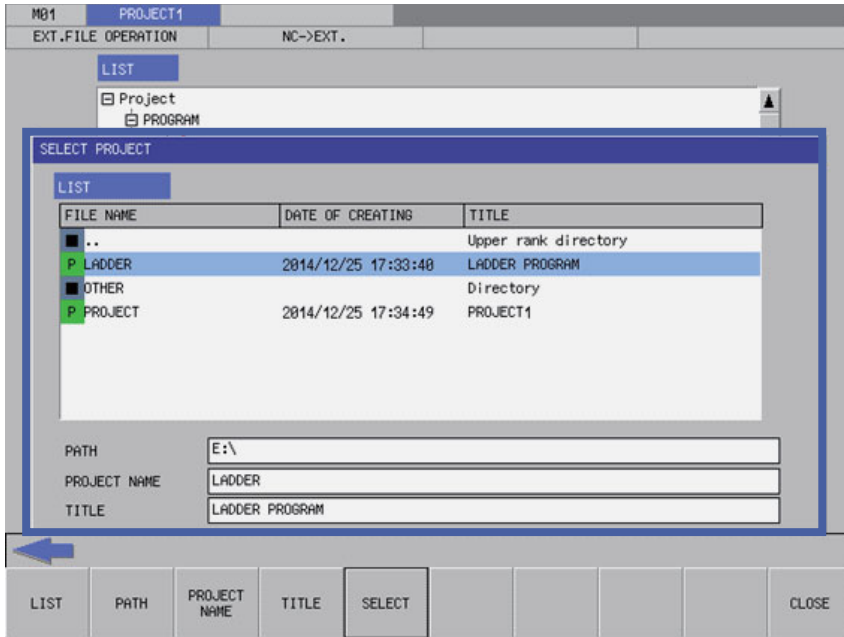

[Message screen]

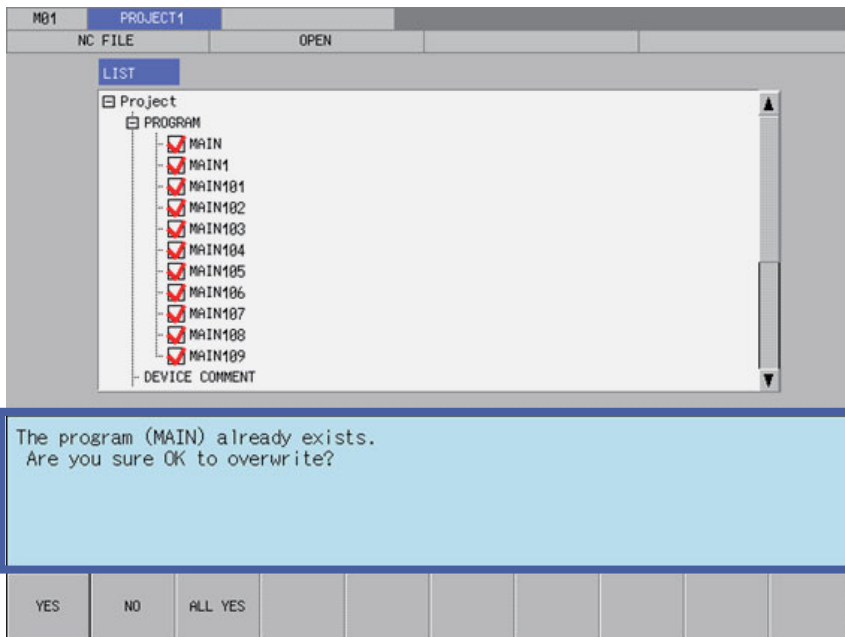

6.2.2 Configuration

6.2.2.1 Common Screen Items

The following diagram illustrates the common screen items.

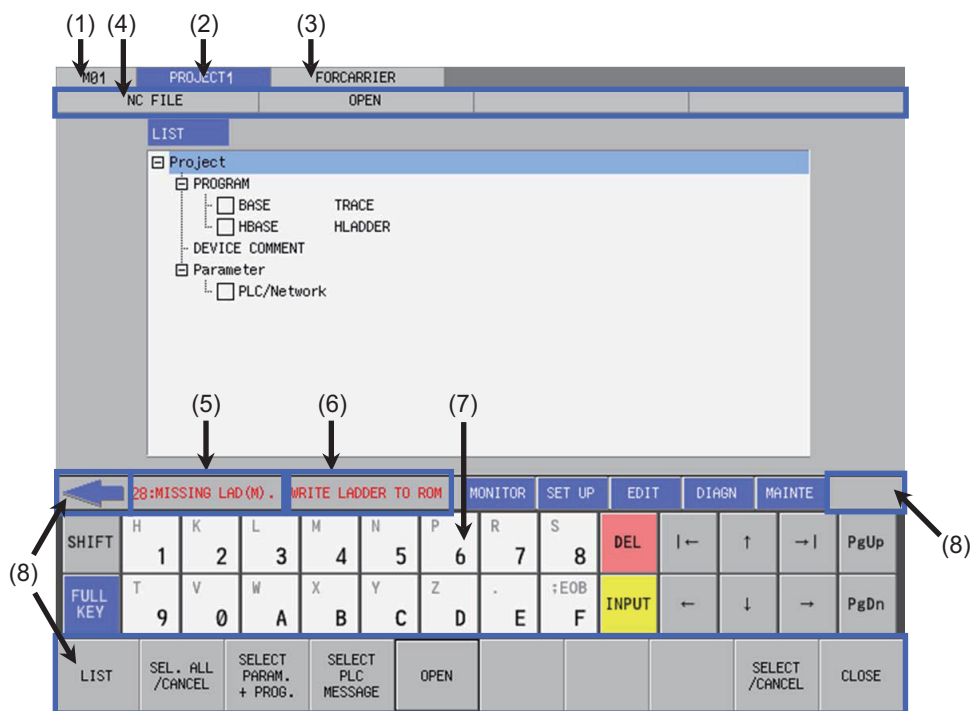

No	Item name	Description
(1)	Connected NC name	This displays the name of the connected NC.
(2)	Current project No.	This displays the current project number. However, if the user safety sequence is set to the operation target, "SafePLC1" or "SafePLC2" is displayed. Background color changes as follows depending the operation mode of the operation target project. <div style="display: flex; justify-content: space-around; align-items: center; margin: 5px 0;"> <div style="border: 1px solid black; padding: 2px 10px; background-color: #4a7ebb; color: white;">PROJECT1</div> <div style="border: 1px solid black; padding: 2px 10px; background-color: #006400; color: white;">PROJECT1</div> </div> GX Developer: Blue GX Works2: Green For details on the "Operation mode", refer to "6.1.3 Operation Mode of Project".
(3)	Current project label	This displays labels assigned to projects. However, if the user safety sequence is set to the operation target, this section is always blank.
(4)	Menu position display	This displays the menu position for the currently displayed full screen.
(5)	PLC alarm message	[For project] The alarm message is displayed when the user sequence occurred illegally. Refer to "5.13.2 Checking PLC Alarms on CNC Controller" for details. [For user safety sequence] SAFE PLC ALARM is displayed when the user sequence occurred illegally. For the contents of PLC alarm, refer to "NC message" of "Alarm MSG" on the diagnosis screen of Mitsubishi Electric standard screen. Use "Diagn" key described in "6.20.3 Special Keys" to move to the diagnosis screen of Mitsubishi Electric standard screen. For the contents of messages, refer to "M800/M80 Series Smart safety observation Specification manual".
(6)	Unsaved data alarm message	This displays alarm messages when data has not been saved to the internal ROM.
(7)	Soft keyboard	Soft keyboard (only when the software keyboard parameter is enabled)
(8)	Menu keys	This menu is used to operate screens.

6.2.2.2 Items Displayed on the Ladder Screen

The following diagram illustrates the items displayed on the ladder screen.

[Ladder screen (Monitor (RUN))]

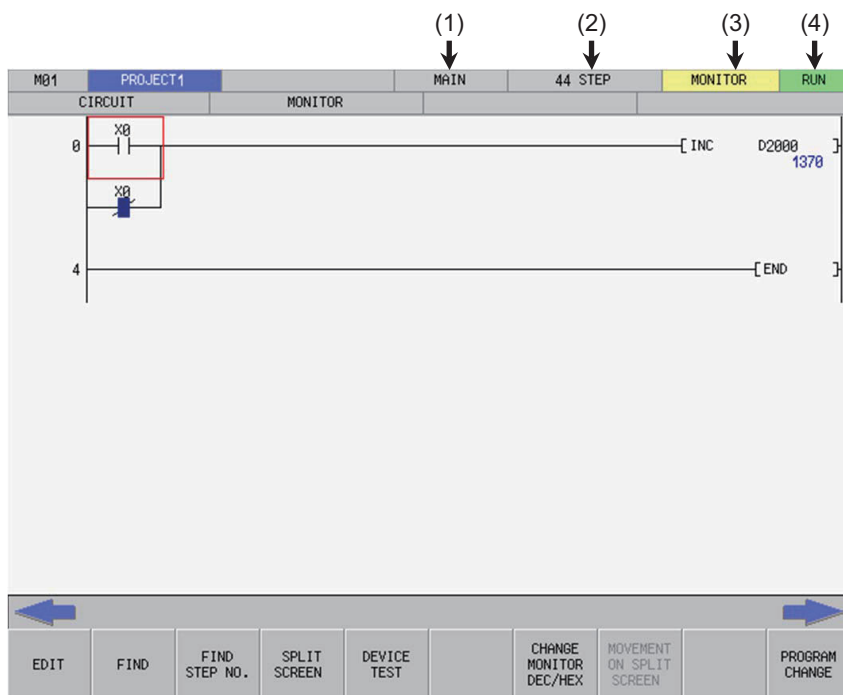

[Ladder screen (Monitor (STOP))]

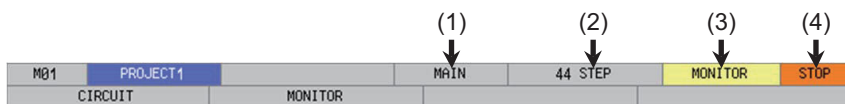

[Ladder screen (Edit (Overwrite))]

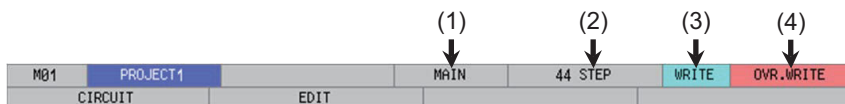

[Ladder screen (Edit (Insert))]

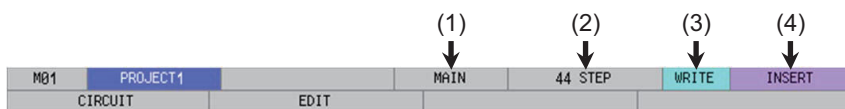

No	Item name	Description
(1)	Program name	This displays the name of the currently displayed program.
(2)	Step number	Display differs depending on the operation mode. ♦ GX Language This displays the total number of file header capacity and program step number. ♦ For GX Works2 This displays the step number of a program.
(3)	Monitor/Edit display	This displays whether the current ladder screen is in the monitored state or the edit state.
(4)	Monitored: PLC status display (RUN/STOP) Edit: Overwrite/Insert display	This displays the PLC status (RUN/STOP) when the ladder screen is in the monitored state. This displays whether the edit mode is in overwrite or insert mode when the ladder screen is in the edit state.

6.2.2.3 Items Displayed on the Sampling Trace Screen

The following diagram illustrates the items displayed on the ladder screen.

[Sampling trace screen (main)]

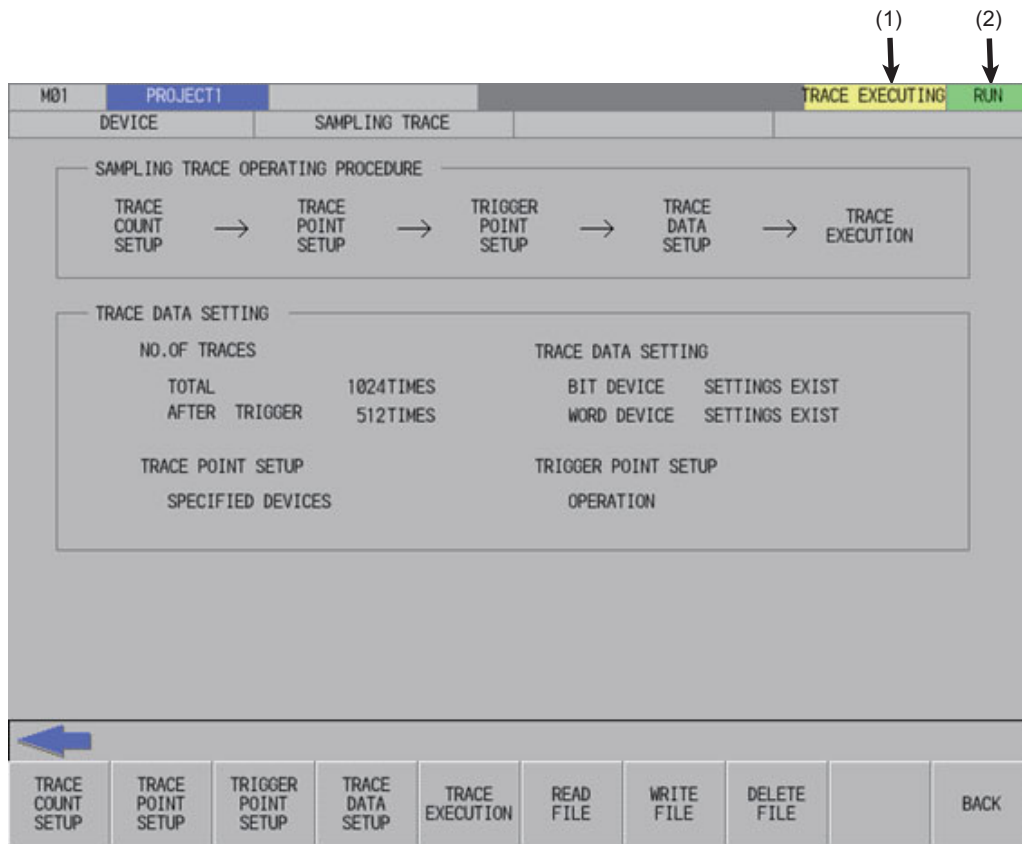

No	Item name	Description
(1)	Trace status display	This displays the trace status (execution failed, trace executing, trace suspend or trace finished).
(2)	PLC status (RUN/STOP) display	This displays the PLC status (RUN/STOP).

6.2.3 Menu Keys

The menu keys consist of the 10 buttons arranged on the bottom of the PLC On-board and the arrow keys arranged on the left and right edges. (area inside the blue lines)

The menu keys may be enabled (black character display) or disabled (gray character display) depending on the state of the NC and the PLC On-board.

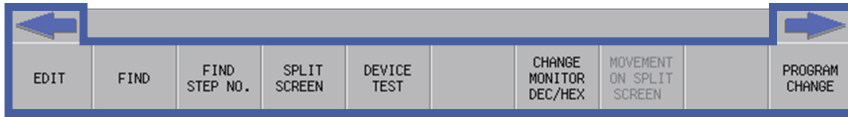

Item name	Description
Menu keys	These execute functions and the display of screens corresponding to the menu names written on the buttons. Blank menu keys are disabled.
Left arrow key	This closes displayed popup screens (described later) and transitions to upper-tier menus.
Right arrow key	This transitions to same-tier menus.

6.2.3.1 Menu Key Tiers and Transitions

The menu keys are divided into several tiers. Pressing corresponding menu keys enables transitions to lower tiers. Pressing the left arrow key enables transitions to higher tiers, and pressing the right arrow key enables transitions on the same tier. The following table summarizes each menu tier.

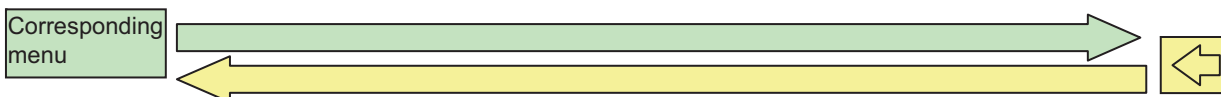

Level 1	Level 2	Level 3	Level 4	
Main	NC file operation			
	External file operation			
	Circuit	Monitor 1 Monitor 2	↕	
		Edit 1 Edit 2	↕	Circuit symbol 1 Circuit symbol 2 Copy/Insert line
		Device	Device batch monitor Device register monitor Sampling trace	
	Parameters	Multi-project parameter	Project settings Device settings	
	PLC diagnosis			
	Environment settings			



Switch pages

Transition to same-tier menus

6.2.3.2 Menu Key Details

Developer Mode Menu Keys

The following describes the menu keys in each tier. (The enabled/disabled status of each menu key is described later.)

■ [MAIN] menu keys

This is the highest tier of the PLC On-board menu. Other types of functions are called from this menu.

[This is the menu available when the sequence program is stored in the connected project.]

NC FILE	EXT. FILE OPERATION	LADDER	DEVICE	PARAM.	PLC DIAGNOSIS	ENVIRON. SETTING			SELECT PROJECT
---------	---------------------	--------	--------	--------	---------------	------------------	--	--	----------------

NC FILE	This changes to the [NC FILE] menu keys.
EXT. FILE OPERATION	This changes to the [EXT. FILE OPERATION] menu keys.
LADDER	This displays the ladder screen and starts the monitor.
DEVICE	This changes to the [DEVICE] menu keys.
PARAM.	This changes to the [PARAM.] menu keys.
PLC DIAGNOSIS	This displays the PLC diagnosis screen.
ENVIRON. SETTING	This changes to the [ENVIRON. SETTING] menu keys.
SELECT PROJECT	This selects the current project. This is enabled when using multiple projects and smart safety observation function is enabled.

[This is the menu available when the sequence program is not stored in the connected project.]

FILE OPE.	EXT.->NC	ROM WRITE	PROJECT SETTING	DEVICE SETTING		PLC DIAGNOSIS	CONNECT NC CHANGING		SELECT PROJECT
-----------	----------	-----------	-----------------	----------------	--	---------------	---------------------	--	----------------

FILE OPE.	This displays the file operation screen.
EXE.->NC	This displays the "EXT.->NC" screen.
ROM WRITE	This displays the ROM write popup screen.
PROJECT SETTING	This displays the project setting screen.
DEVICE SETTING	This displays the device setting screen.
PLC DIAGNOSIS	This displays the diagnosis screen.
CONNECT NC CHANGING	This displays the connect NC change screen.
SELECT PROJECT	This selects the current project. This is enabled when using multiple projects and smart safety observation function is enabled.

■ [NC FILE] menu keys

This menu contains various operations for files stored in the NC such as opening files stored in and confirming information of files stored in the NC.

LIST	OPEN	FILE OPE.	FORMAT	ROM WRITE	PLC RUN/STOP	PASSWORD CANCEL.	PLC VERSION UP		BACK
------	------	-----------	--------	-----------	--------------	------------------	----------------	--	------

LIST	This displays the file list screen.
OPEN	This displays the open screen.
FILE OPE.	This displays the file operation screen.
FORMAT	This displays the format popup screen.
ROM WRITE	This displays the rom write popup screen.
PLC RUN/STOP	This displays the PLC RUN/STOP popup screen.
PASSWORD CANCEL.	This displays the password cancellation popup screen.
PLC VERSION UP	This displays the plc version up screen.
BACK	This returns to the main menu keys.

■ [EXT.FILE OPERATION] menu keys

This menu contains various operations for external files such as saving files stored in SD cards and USB memory devices into NC.

EXT.->NC	NC->EXT.	DELETE EXT. FILE	VERIFY EXT.FILE				PLC RUN/STOP	PASSWORD CANCEL.	BACK
----------	----------	------------------	-----------------	--	--	--	--------------	------------------	------

EXT.->NC	This displays the "EXT.->NC" screen.
NC->EXT.	This displays the "NC->EXT." screen.
DELETE EXT. FILE	This displays the delete external file screen.
VERIFY EXT. FILE	This displays the verify external file screen.
PLC RUN/STOP	This displays the PLC RUN/STOP popup screen.
PASSWORD CANCEL.	This displays the password cancellation popup screen.
BACK	This returns to the main menu keys.

6 Explanation of Built-in Editing Function (PLC On-board)

6.2 Screen Configuration

■ [LADDER] menu keys

[Monitoring menus]

This menu contains functions used to monitor circuits.

- ♦ First page

EDIT	FIND	FIND STEP NO.	SPLIT SCREEN	DEVICE TEST		CHANGE MONITOR DEC/HEX	MOVEMENT ON SPLIT SCREEN		PROGRAM CHANGE
------	------	---------------	--------------	-------------	--	------------------------	--------------------------	--	----------------

- ♦ Second page

CROSS REF. LIST	LIST OF USED DEVICES		COMMENT ON/OFF				ZOOM DISPLAY	PLC RUN/STOP
-----------------	----------------------	--	----------------	--	--	--	--------------	--------------

EDIT	This switches to the edit mode.
FIND	This displays the find popup screen.
FIND STEP NO.	This displays the find step No. popup screen.
SPLIT SCREEN	This displays the [SPLIT SCREEN] menu.
DEVICE TEST	This displays the device test popup screen.
CHANGE MONITOR DEC/HEX	This changes the current value display between decimal and hexadecimal.
MOVEMENT ON SPLIT SCREEN	This transitions the focus between the split screens.
PROGRAM CHANGE	This changes to the selected program.
CROSS REF. LIST	This displays the contact coil usage popup screen.
LIST OF USED DEVICES	This displays the list of used devices popup screen.
COMMENT ON/OFF	This turns the device comment display ON and OFF.
FB Instance Monitor	This displays the FB instance monitor at a cursor position.
ZOOM DISPLAY	This changes the display magnification of the ladder screen.
PLC RUN/STOP	This displays the PLC RUN/STOP popup screen.

[Split screen menus]

This menu contains functions used to operate the split screen.

ENTRY DEVICE	ENTRY LADDER MONITOR		REGISTER MONITOR			MOVEMENT ON SPLIT SCREEN	PROGRAM CHANGE
--------------	----------------------	--	------------------	--	--	--------------------------	----------------

ENTRY DEVICE	This turns the entry device monitor screen ON and OFF.
ENTRY LADDER MONITOR	This turns the entry ladder monitor screen ON and OFF.
REGISTER MONITOR	This registers the ladder on the cursor position in the ladder registration monitor.
MOVEMENT ON SPLIT SCREEN	This transitions the focus between the split screens.
PROGRAM CHANGE	This changes to the selected program.

[Entry device (split screen) menus]

This menu contains functions used to operate the device registration monitor (split screen).

DEVICE TEST			16BIT/32BIT	DEC/HEX		MOVEMENT ON SPLIT SCREEN	PLC RUN/STOP	CLOSE
-------------	--	--	-------------	---------	--	--------------------------	--------------	-------

DEVICE TEST	This displays the device test popup screen.
16BIT/32BIT	This switches the current value display between 16 bits/32 bits.
DEC/HEX	This changes the current value display between decimal and hexadecimal.
MOVEMENT ON SPLIT SCREEN	This transitions the focus between the split screens.
PLC RUN/STOP	This displays the PLC RUN/STOP popup screen.
CLOSE	This closes the entry device monitor screen.

6 Explanation of Built-in Editing Function (PLC On-board)

6.2 Screen Configuration

[Entry ladder monitor (split screen) menus]

This menu contains functions used to operate the Entry Ladder monitor (split screen).

FIND	DEVICE TEST	ENTRY LADDER ALL DEL.	DIVISION RATIO CHANGE	MOVEMENT ON SPLIT SCREEN	ZOOM DISPLAY	PLC RUN/STOP	CLOSE
------	-------------	-----------------------	-----------------------	--------------------------	--------------	--------------	-------

FIND	This displays the find popup screen.
DEVICE TEST	This displays the device test popup screen.
ENTRY LADDER ALL DEL.	This deletes all circuits registered in the Entry Ladder monitor.
DIVISION RATIO CHANGE	This changes the ratio of the split screens for the ladder registration monitor.
MOVEMENT ON SPLIT SCREEN	This transitions the focus between the split screens.
ZOOM DISPLAY	This changes the display magnification of the ladder screen.
PLC RUN/STOP	This displays the PLC RUN/STOP popup screen.
CLOSE	This closes the entry ladder monitor screen.

[FB instance monitor menu]

This menu contains functions used to operate the FB instance monitor.

FIND	FIND STEP NO.	DEVICE TEST	FB Instance Monitor	CHANGE MONITOR DEC/HEX	PLC RUN/STOP	COMMENT ON/OFF	ZOOM DISPLAY	BACK
------	---------------	-------------	---------------------	------------------------	--------------	----------------	--------------	------

FIND	This displays the find popup screen.
FIND STEP NO.	This displays the find step No. popup screen.
DEVICE TEST	This displays the device test popup screen.
FB Instance Monitor	This displays the FB instance monitor at a cursor position.
Current Value Monitor Changeover (10/16)	This changes the current value display between decimal and hexadecimal.
PLC RUN/STOP	This displays the PLC RUN/STOP popup screen.
Comment ON/OFF	This turns the device comment display ON and OFF.
ZOOM DISPLAY	This changes the display magnification of the ladder screen.
BACK	This returns to "Ladder monitor" screen or "FB instance monitor" screen.

6 Explanation of Built-in Editing Function (PLC On-board)

6.2 Screen Configuration

[Edit menus]

This menu contains functions used to edit circuits.

- ♦ First page

MONITOR	LADDER SYMBOL1	LADDER SYMBOL2	COPY/INSERT	FIND	FIND STEP NO.	CONVERT LADDER	UNDO		PROGRAM CHANGE
---------	----------------	----------------	-------------	------	---------------	----------------	------	--	----------------

- ♦ Second page

CROSS REF. LIST	LIST OF USED DEVICES	CHECK PROGRAM	COMMENT ON/OFF			CANCEL EDIT LADDER		ZOOM DISPLAY	OVR. WRITE /INSERT
-----------------	----------------------	---------------	----------------	--	--	--------------------	--	--------------	--------------------

MONITOR	This switches to the monitor mode.
Ladder Symbol 1	This switches to the [LADDER SYMBOL1] menu.
LADDER SYMBOL2	This switches to the [LADDER SYMBOL2] menu.
COPY/INSERT	This switches to the [COPY/INSERT] menu.
FIND	This displays the find popup screen.
FIND STEP NO.	This displays the find step No. popup screen.
CONVERT LADDER	This converts edited circuits.
UNDO	This returns the pre-converted ladder to the last previous state while editing.
PROGRAM CHANGE	This changes to the selected program.
CROSS REF. LIST	This displays the contact coil usage popup screen.
LIST OF USED DEVICES	This displays the list of used devices popup screen.
CHECK PROGRAM	This opens the check program popup screen.
COMMENT ON/OFF	This turns the device comment display ON and OFF.
CANCEL EDIT LADDER	This discards the unconverted ladder.
ZOOM DISPLAY	This changes the display magnification of the ladder screen.
OVR.WRITE/INSERT	This switches the edit mode between overwrite and insert mode.

[Menus of ladder symbol 1 and 2]

This menu contains ladder symbols used to edit circuits.

- ♦ [LADDER SYMBOL1] menu

- -	- / -	+ +	+ / +	<< >>	-[]-	-		CONVERT LADDER	UNDO
-------	-------	-------	-------	-------	-------	---	--	----------------	------

- ♦ [LADDER SYMBOL2] menu

- P -	- F -	+ P +	+ F +	-P-	-F-	-/-	DELETE	CONVERT LADDER	UNDO
-------	-------	-------	-------	-----	-----	-----	--------	----------------	------

Ladder symbols other than the following	This opens the enter symbol popup screen.
- (Horizontal bar)	Writes the horizontal bar to the cursor position.
(Vertical bar)	Writes the vertical bar to the cursor position.
DELETE (Vertical bar)	This deletes the vertical bar at the cursor position.
CONVERT LADDER	This converts edited circuits.
UNDO	This returns the pre-converted ladder to the last previous state while editing.

6 Explanation of Built-in Editing Function (PLC On-board)

6.2 Screen Configuration

[Copy/insert menus]

This menu contains the copy, paste, line insert, and line delete functions.

MARK	COPY	PASTE	INSERT LINE	DELETE LINE				CONVERT LADDER	UNDO
------	------	-------	-------------	-------------	--	--	--	----------------	------

MARK	Ladder groups are selected by designating start points and end points.
COPY	This copies the ladder in the designated range.
PASTE	This pastes copied circuits at the cursor position.
INSERT LINE	This inserts one blank line at the cursor position.
DELETE LINE	This deletes the line at the cursor position.
CONVERT LADDER	This converts edited circuits.
UNDO	This returns the pre-converted ladder to the last previous state while editing.

■ **[DEVICE] menu keys**

This menu contains functions used to monitor desired devices.

DEVICE BATCH	ENTRY DEVICE	SAMPLING TRACE							BACK
--------------	--------------	----------------	--	--	--	--	--	--	------

DEVICE BATCH	This opens the device batch monitor screen.
ENTRY DEVICE	This displays the entry device monitor screen.
SAMPLING TRACE	This displays the sampling trace screen.
BACK	This returns to the main menu keys.

■ **[PARAM.] menu keys**

This menu contains functions used to configure operation of programs and multiple projects.

PROGRAM SETTING	COMMON POINTER SETTING			MULTI PROJECT PARAM.				BACK
-----------------	------------------------	--	--	----------------------	--	--	--	------

PROGRAM SETTING	This displays the program setting screen.
COMMON POINTER SETTING	This displays the common pointer setting screen.
MULTI PROJECT PARAM.	This switches to the [MULTI PROJECT PARAM.] menu keys.
BACK	This returns to the main menu keys.

■ **[ENVIRON. SETTING] menu keys**

This menu contains functions used to configure the PLC On-board usage environment such as ladder screen settings and locations to store device comments.

COMMENT DISPLAY	LADDER DISPLAY			CONNECT NC CHANGING				BACK
-----------------	----------------	--	--	---------------------	--	--	--	------

COMMENT DISPLAY	This displays the comment display screen.
LADDER DISPLAY	This screen displays the ladder display screen.
CONNECT NC CHANGING	This displays the connect NC change screen.
BACK	This returns to the main menu keys.

6.3 Operation Key List

6.3.1 Basic Operation Keys

The following table lists the keys used to operate the PLC On-board.

Key	Description
A to Z, 0 to 9	These keys are used to enter data.
One-byte symbols such as "!"	These keys are used to enter password to cancel block password.
INSERT	This key changes the edit mode when editing circuits between the overwrite and insert modes.
DELETE	This key deletes the last character input that has not yet been issued.
C.B	This key deletes input character strings that have not yet been issued.
INPUT	This key issues the input data. It also selects data.
↑, ↓, →, ←	These keys are used to move the cursor up, down, left and right and to select items.
→	This key moves screen items in the forward order.
←	This key moves screen items in the reverse order.
← or ESC	These keys transition to the next highest menu tier and close popup windows.
→	This transitions to same-tier menus.
Page Up	This key moves screens up in pages.
Page Down	This key moves screens down in pages.
SP	This key enters and removes checks from check boxes.
<,>	The "<,>" key may not be available depending on the specific model. In such a case, use the "(,)" key as a substitute.
EOB	This key turns the display of device comments on the ladder screen ON and OFF.
#	This key switches between screens when using the split screen display.

6.3.2 Screen Items (Control)

Table background colors

Some of the tables used in PLC On-board screens contain both areas where values are input and areas where values are selected. For this reason, different background colors are used to visually distinguish between input areas and selection areas. The following table describes these background colors.

Background color	Description
White	Indicates areas where values are input. (area inside the green lines in the following diagram)
Yellow	Indicates areas where values are selected. (area inside the blue lines in the following diagram)
Light blue	Indicates the position of the current selection under focus. (area inside the red lines in the following diagram)
Gray	Indicates areas where values cannot be input or selected.

PROJECT No.	01	02	03	04	05	06
PROJ. RATIO (%)	20	16	16	16	16	16
EXECUTE PROJECT	ON	OFF	OFF	OFF	OFF	OFF
EXE.ORDER	1	2	3	4	5	6

Selecting input and selection items

There are two methods used to select input and selection items.

■ Select using the Tab keys (→ |, | ←)

Select and enable items that can be input or selected in a predetermined order. The background color of the title of a selected item changes to blue. (Refer to the area of the following diagram with a red circle.)

[(Example) "CROSS REF. LIST" screen]

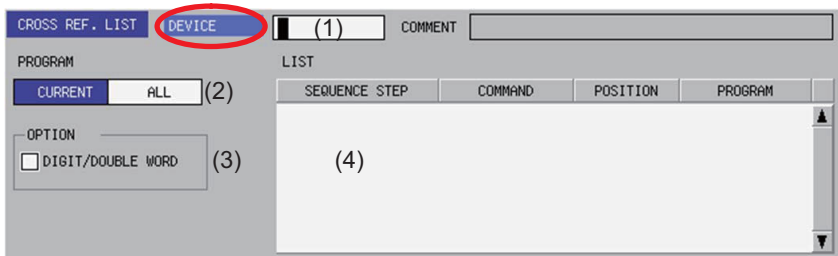

Operation	Description
Press [→]	Selects items in forward order from (1) to (2), returning back from (4) to (1).
Press [←]	Selects items in reverse order from (4) to (3), returning back from (1) to (4).

■ Select using menu keys

Select and enable input and selection items by pressing the menu keys corresponding to the input and selection items. The background color of the title of a selected item changes to blue.

[(Example) "CROSS REF. LIST" screen]

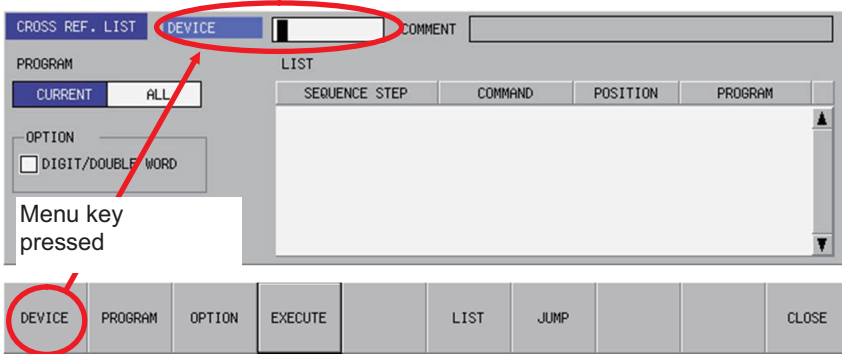

Selecting the input position

There are multiple input positions when inputting values into lists and tables. Select the desired input position by using the following method.

- (1) Select the item such as a list or table. (Refer to "Selecting input and selection items")
- (2) Use the [↑], [↓], [←], and [→] keys to move to the desired input position.

[(Example) Lists within the entry device monitor screen]

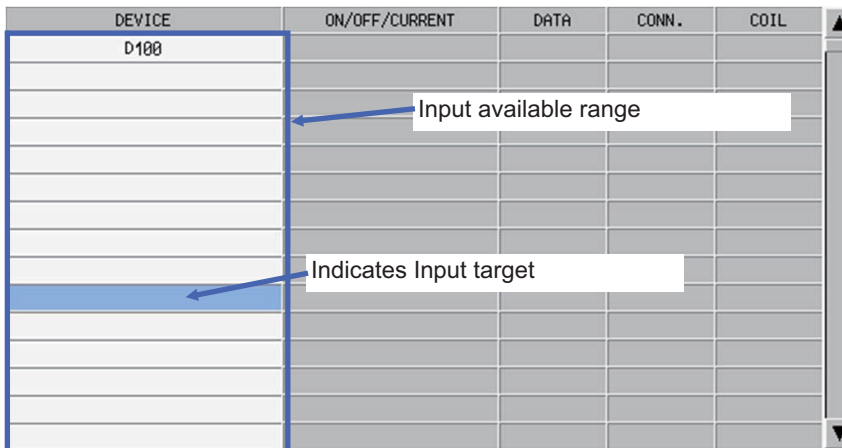

Inputting values

■ Items that can be input directly

Perform the following operation to input values (text strings and numbers) into direct-input items such as that marked by the red circle in the following diagram.

- (1) Select the input item. (Refer to "Selecting input and selection items")
- (2) Use the keyboard to input values.

[(Example) "CROSS REF. LIST" screen]

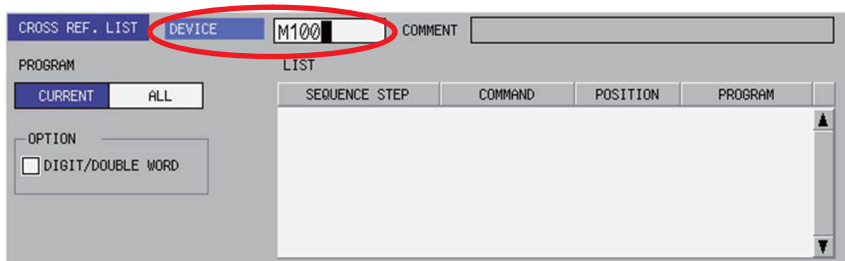

Press the [INSERT] key to switch between the two edit modes (overwrite/insert). Switching the edit mode changes the shape of the cursor.

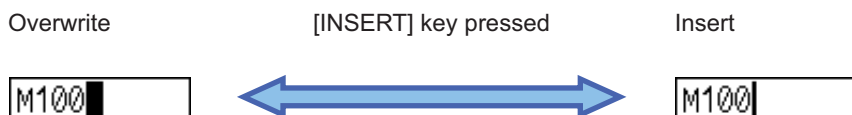

■ Items that cannot be input directly

Perform the following operation to input values (text strings and numbers) into input items not capable of direct input such as lists.

- (1) Select the input position in the list. (Refer to "Selecting the input position")
- (2) Use the keyboard to issue the [INPUT] key.

Issuing the [INPUT] key displays and selects the input item (area inside the blue lines in the following diagram).



- (3) Use the keyboard to input values.
- (4) Use the keyboard to issue the [INPUT] key.

Issuing the [INPUT] key closes the input item and displays the input item at the selected position.

DEVICE	ON/OFF/CURRENT	DATA	CONN.	COIL
D100				

Configuring unique selection items

Only one data item is selected from two or more data items. The highlighted data is the currently selected item. There are two methods used to change selections.

- Press the menu key with the same name as the item to move the selection data move in the right direction. The selection will move to the left-most position when the currently selected item is at the right-most position.

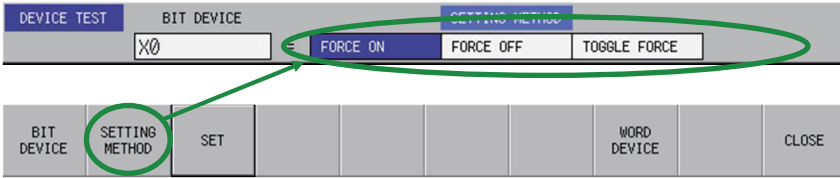

Pressing the applicable menu key moves the selection as illustrated in the following diagram.

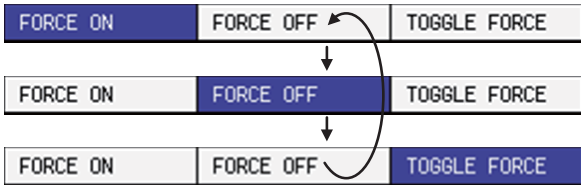

- After selecting an item with the Tab key, press the [←] and [→] to move the selection. If the currently selected item is at the right-most position, the selection moves to the left-most position. If the currently selected item is at the left-most position, the selection moves to the right-most position.



The selection moves to the right as illustrated in the following figure when the [→] key is pressed.

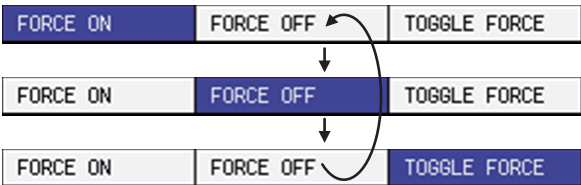

The selection moves to the left as illustrated in the following figure when the [←] key is pressed.

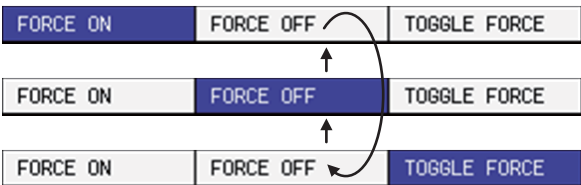

Selecting tree-structure data

Tree-structure data is configured of directories and data.

Directories and data are illustrated in the following diagram.

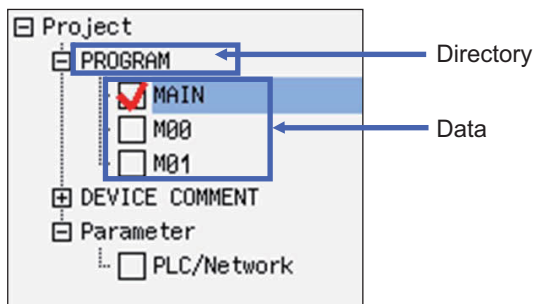

■ Transitioning between/selecting directories and data

Use the [↑], [↓], [←], and [→] arrow keys to move between and select data one unit at a time. Use the [Page Up] and [Page Down] keys to move between pages one at a time and to select data.

■ Enabling and disabling data to be processed

The check box has two types of statuses: where the selection/deselection is enabled (white rectangle) or disabled (gray rectangle).

There are two methods used to enable and disable selections.

- Move to and select the data to be set and press the [SP (space code)] key.
Selections that are checked are enabled and selections that are not checked are disabled.
Each press of the [SP] key switches between the enabled and disabled state.
- Move to and select the data to be set and press the [SELECT/CANCEL] menu key.
Selections that are checked are enabled and selections that are not checked are disabled.
Each press of the [SELECT/CANCEL] menu key switches between the enabled and disabled state.

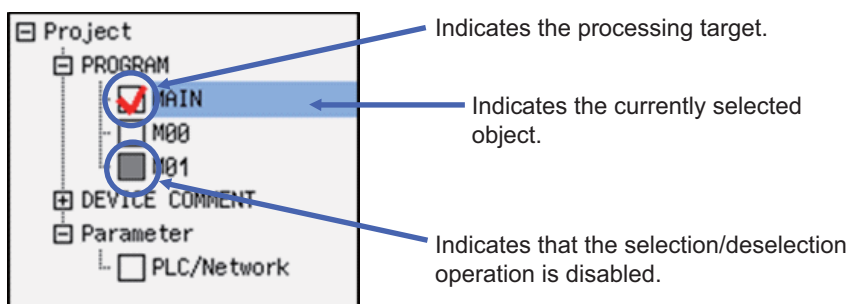

■ [+] and [-] symbols next to directories

- Pressing the [→] key for directories marked with the [+] symbol expands the directory to display the data within.
- Pressing the [←] key for directories marked with the [-] symbol collapses the directory to no longer display the data within.

6 Explanation of Built-in Editing Function (PLC On-board)

6.3 Operation Key List

Setting selection items in lists

Select one item of data from lists containing multiple entries of data. The example used to describe the selection method is a screen containing UI elements for selecting data from a list.

■ **Switching between programs or other types of data**

Pressing the [SWITCH PROGRAM] menu key displays the name of the programs stored in NC in the list. The currently displayed data is selected (highlighted). Use the [↑] and [↓] arrow keys to change the selected data.

Press the [INPUT] key to issue the selection.

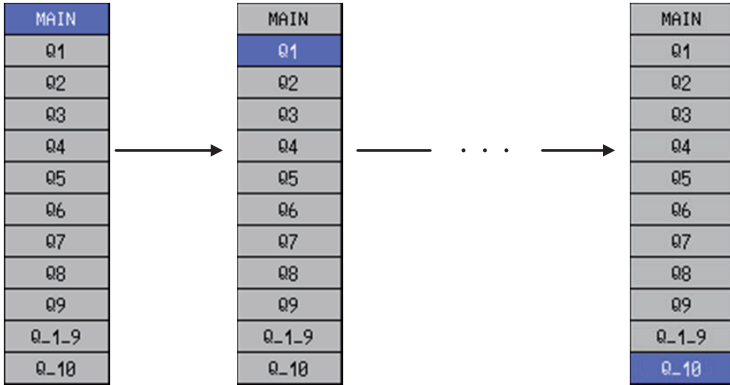

If there are multiple stored programs that cannot be displayed on one screen, a triangle pointing down is displayed under the final data display on the screen as illustrated in the following diagram. As illustrated in the preceding diagram, use the [↑] and [↓] arrow keys to move the selection to the triangle pointing downward and display the next page. Repeat this operation to move to the last page.

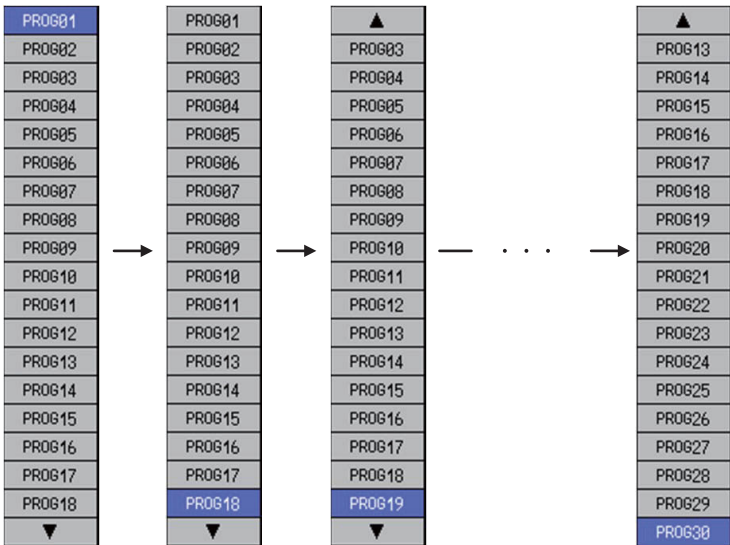

■ **Selecting external projects or other data**

Directories and project data displayed in the [LIST] can be selected and the contents of directories can be displayed.

FILE NAME	DATE OF CREATING	TITLE
D ..		Upper rank directory
P LADDER	2014/12/25 17:33:40	LADDER PROGRAM
D OTHER		Directory
P PROJECT	2014/12/25 17:34:49	PROJECT1

Use the [↑] and [↓] arrow keys to change selections when lists as in the preceding diagram are displayed. The background color of selected items is light blue.

Select items marked with **D** icon in the name display column and labeled as [DIRECTORY] in the title column and press the [INPUT] key or "Select" menu key to display the information within the selected directory.

Select directory icons indicated by ".." and press the [INPUT] key to display information in parent directories.

Items indicated by **P** icon in the name display column project data. Use the [↑] and [↓] arrow keys to select data and then operate the menu keys on the screen to issue the selection.

Enabling and disabling selected parameters

You can enable and disable various parameters. There are two methods used to make these settings.

- Press the menu key with the same name as the parameter to select the parameter if not already selected. Press the same menu key again to enable (add a check mark to) the parameter. If the parameter is already selected, the parameter is enabled (check mark is added) when the menu key is pressed. Pressing the menu key when the parameter is enabled disables (clears the check mark from) the parameter. Continually pressing the same menu key switches between the enabled and disabled state.
- After selecting the parameter with the Tab key, press the [SP] key to switch between the enabled and disabled state.

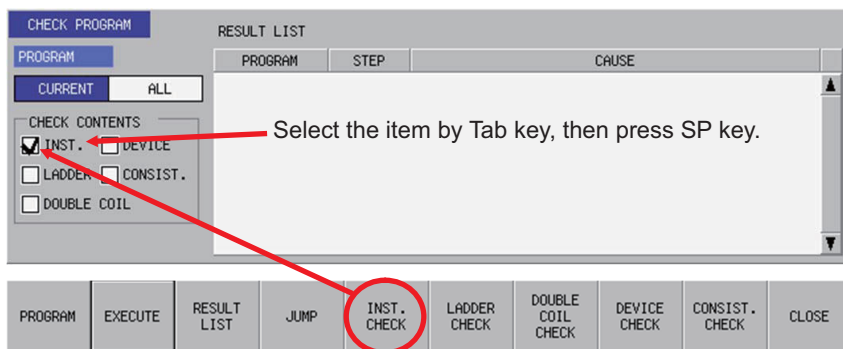

6.4 Touch Gestures

Touch gestures are available for touch panel display devices.

The available touch gestures are listed below.

Gesture		Description
Name	Description	
Tap	A gesture to tap the screen to touch for a moment	Selects items that can be input or selected.
Double-tap	Tap twice quickly	Monitor ladder <ul style="list-style-type: none"> ♦ The find popup screen is displayed by double-tapping other than FB. ♦ The FB instance monitor screen is displayed by double-tapping FB. Displays the enter symbol popup screen in the ladder edit.
Flick	Quickly run your fingertip along the screen vertically or horizontally	Scrolls the screen.
Pan	Put your fingertip on the screen and move it vertically or horizontally while keeping it touching the screen	Scrolls the screen.
Pinch-in	A gesture to pinch a target between the thumb and index finger on the screen	Reduces the screen in the ladder monitor/ladder edit.
Pinch-out	A gesture to spread the thumb and index finger on the screen	Enlarges the screen in the ladder monitor/ladder edit.

6.4.1 Tap

The behavior differs for each tap item.

See more details below.

Items that can be input or selected

Selecting input and selection items with keys can also be executed by tapping.

When you tap the item that can be input or selected, the item is selected and enabled.

[(Example) "CROSS REF. LIST" screen]

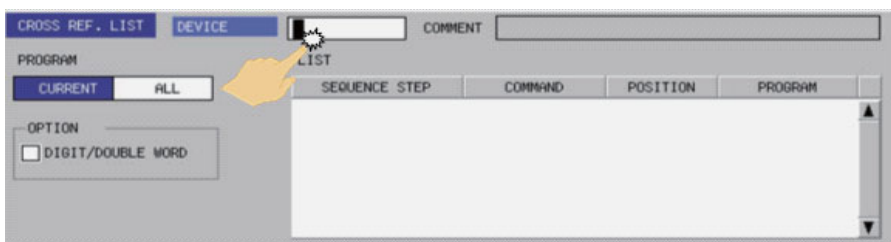

Tree-structure

Selecting tree-structure data with keys can also be executed by tapping.

Tree-structure data is configured of directories and data. Thus the behavior differs depending on the part to be tapped.

■ When tapping a name

When tapping the name of the data or directory name, the tapped data or directory is selected.

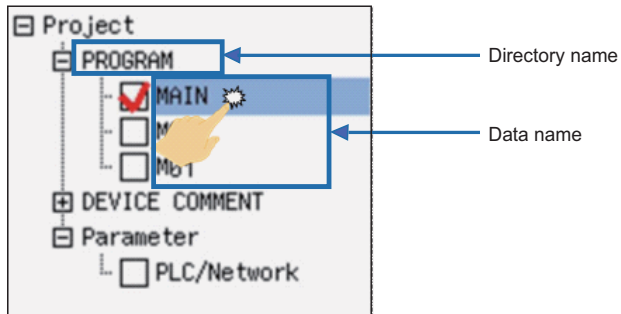

■ When tapping a check box

Every time you tap the check box, a tick is added to or removed from the box.

The box with a tick mark means enabled, whereas the box without a tick means disabled.

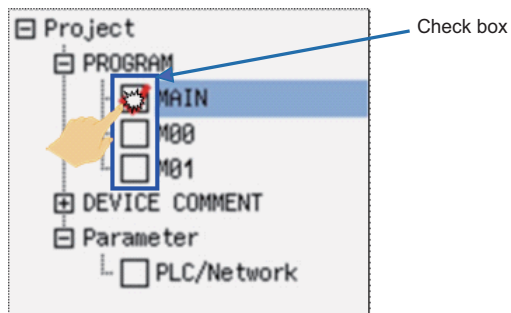

■ When tapping [+] or [-]

Every time you tap the [+] or [-] button, the data in the directory is shown or hidden.

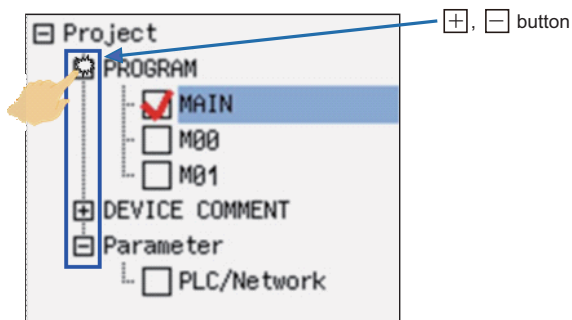

Selection items in lists

Setting selection items in lists with keys can also be executed by tapping.

■ Switching between programs or other types of data

By tapping a program on the switch program screen, the program is switched to the tapped one.

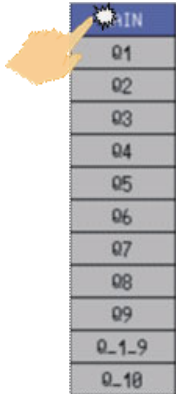

■ Selecting external projects or other data

Directories and project data displayed in the [LIST] can be selected.

FILE NAME	DATE OF CREATING	TITLE
D ..		Upper rank directory
P LADDER	2014/12/25 17:33:40	LADDER PROGRAM
D OTHER		Directory
P PROJECT	2014/12/25 17:34:49	PROJECT1

Enabling and disabling selected items

Enabling and disabling selected items with keys can also be executed by tapping.

You can enable or disable various items by tapping.

[(Example) "CHECK PROGRAM" popup screen]

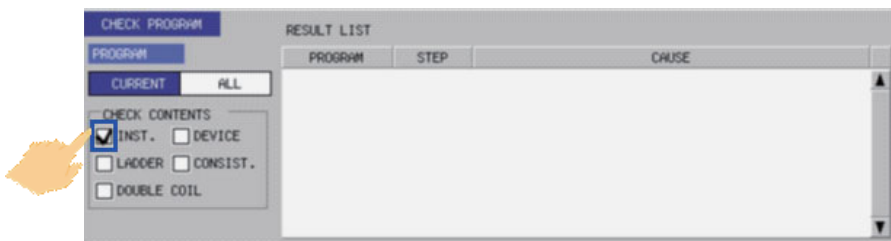

6.4.2 Double-tap

Double-tap on ladder diagrams is available for the ladder monitor/ladder edit.

See more details below.

Ladder monitor

[When double-tapping other than FB]

The find popup screen is displayed by double-tapping.

Refer to "6.15.3 Find Popup Screen" for details of the find popup screen.

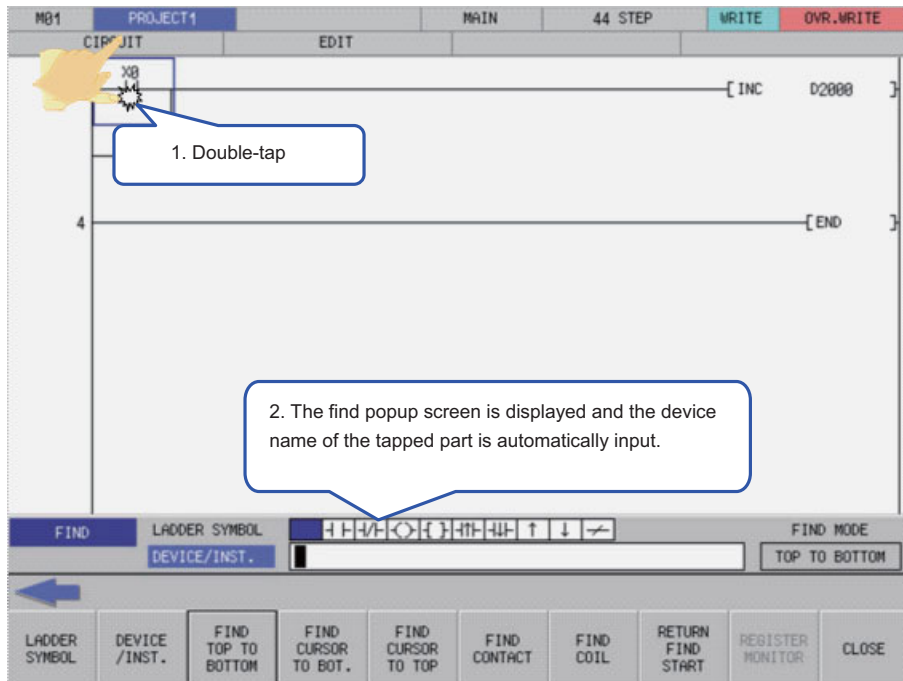

[When double-tapping FB]

The FB instance monitor screen, not the find popup, is displayed by double-tapping FB. Refer to "6.15.10 FB Instance Monitor Screen" for details.

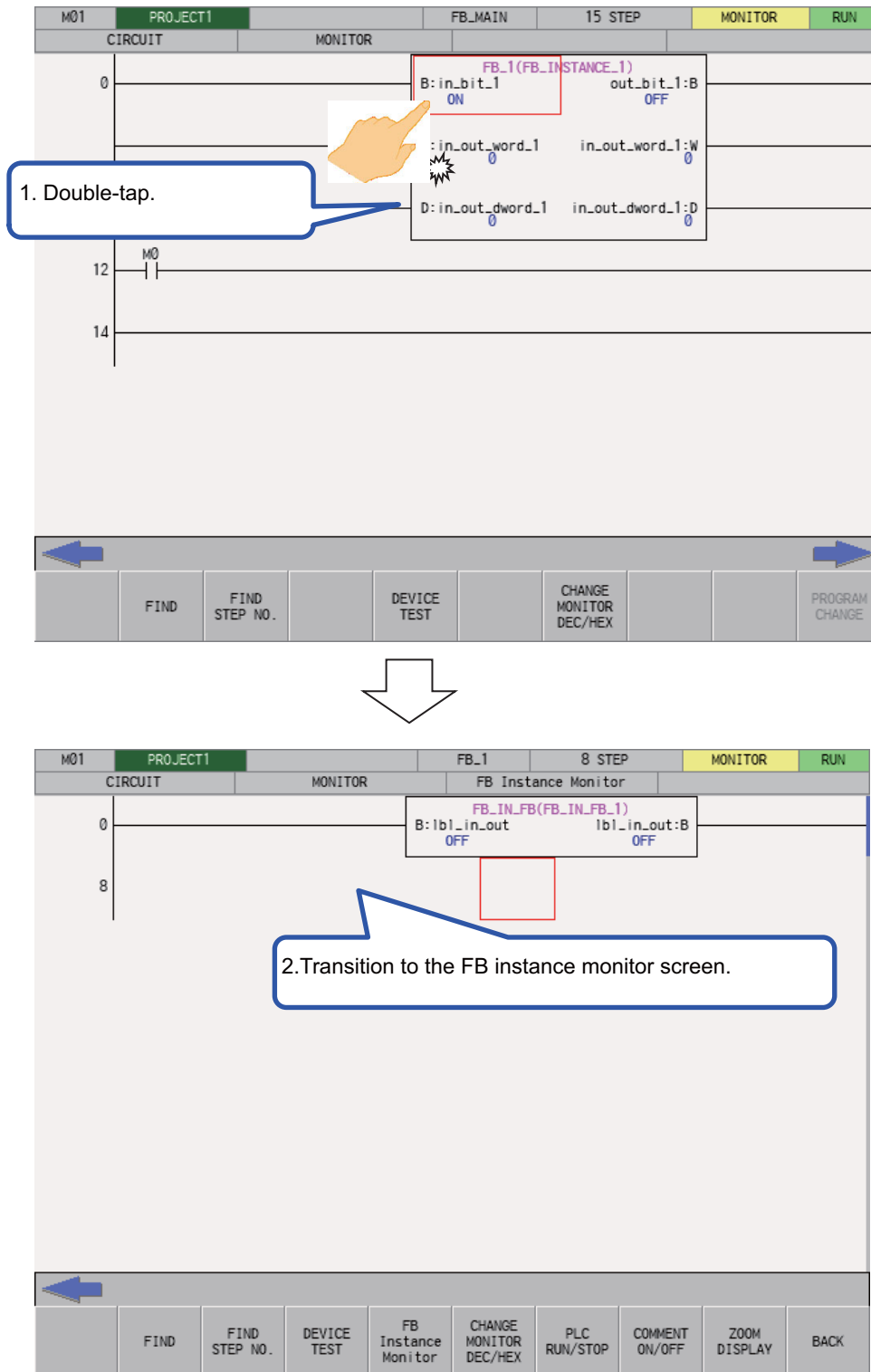

Ladder edit

The enter symbol popup screen is displayed by double-tapping.

Refer to "6.15.2 Editing Ladders" for details of the enter symbol popup screen.

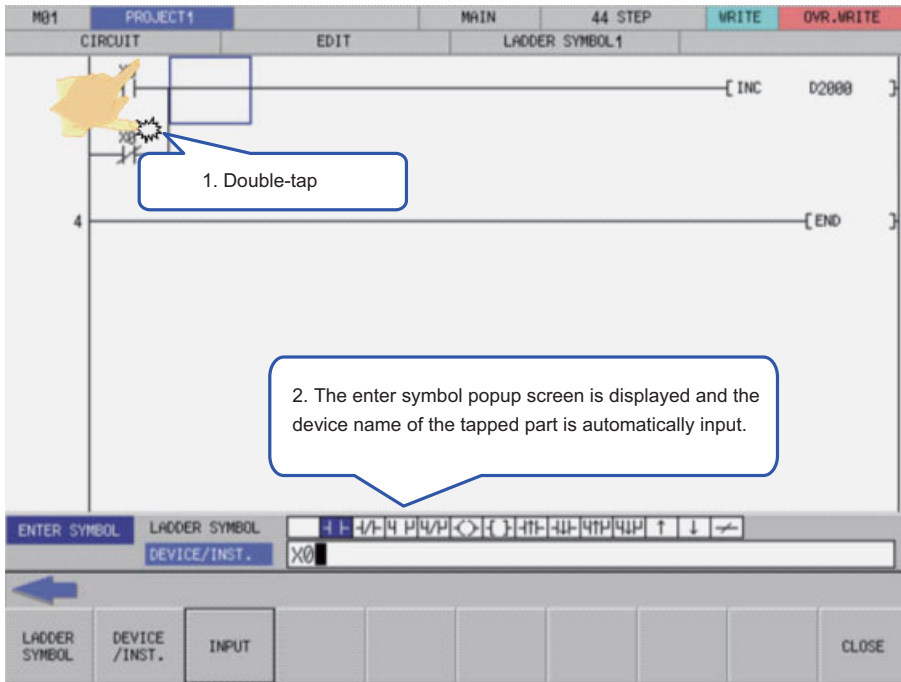

6.4.3 Flick/Pan

For scrollable items, the screen can be scrolled by flick or pan.

[(Example) "FILE LIST" screen (Flick)]

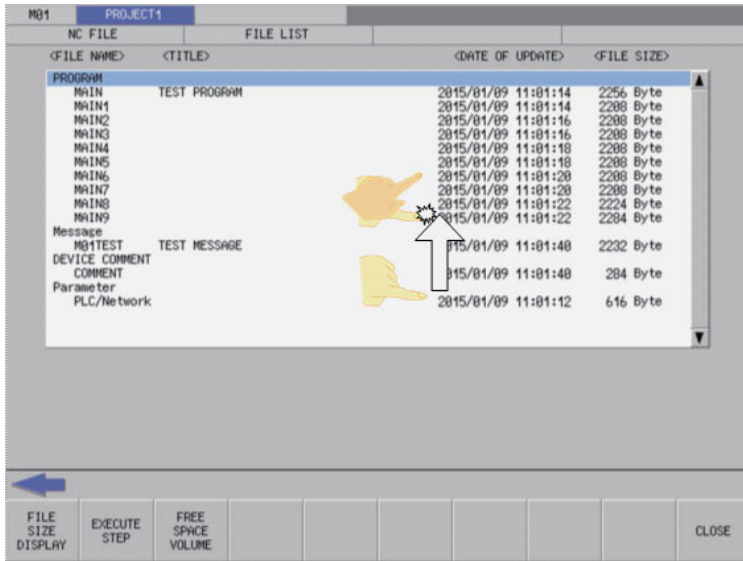

[(Example) "FILE LIST" screen (Pan)]

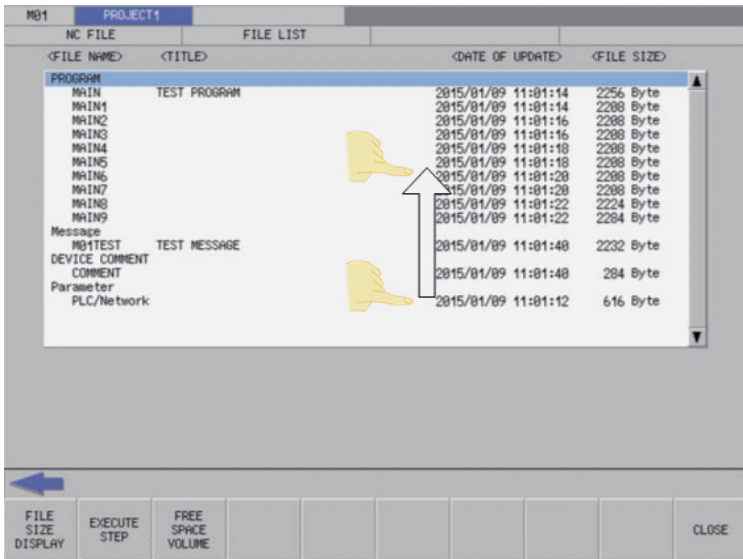

6.4.4 Pinch-in/Pinch-out

When zoom display menu is enabled in the ladder monitor/ladder edit, reduced display by pinch-in (Enlarged -> Standard -> Reduced) and enlarged display by pinch-out (Reduced -> Standard -> Enlarged) are available.

Refer to the following for the condition to enable the zoom display menu.

Ladder monitor: "6.15.1.3 Enabled/Disabled State of Menu Keys"

Ladder edit: "6.15.2.3 Enabled/Disabled State of Menu Keys"

[(Example) Ladder monitor screen (Reduced by pinch-in)]

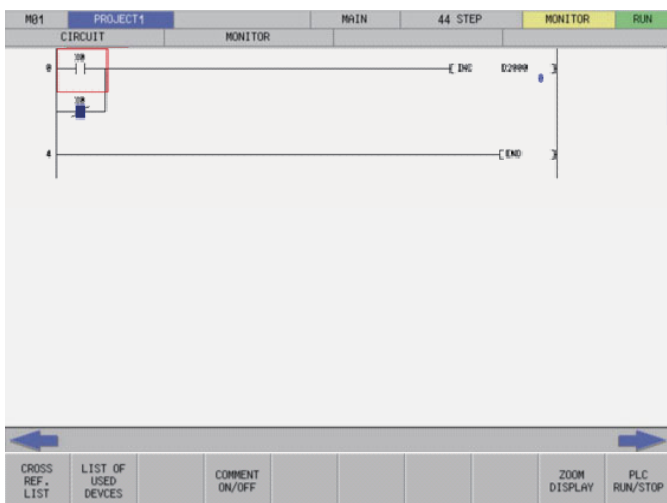
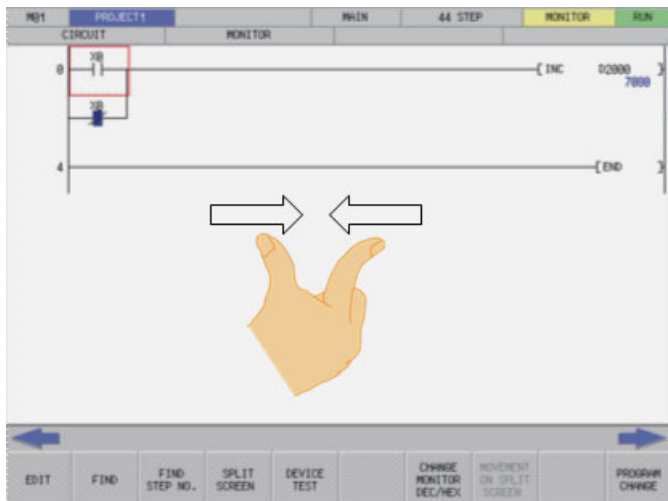

[(Example) Ladder monitor screen (Enlarged by pinch-out)]

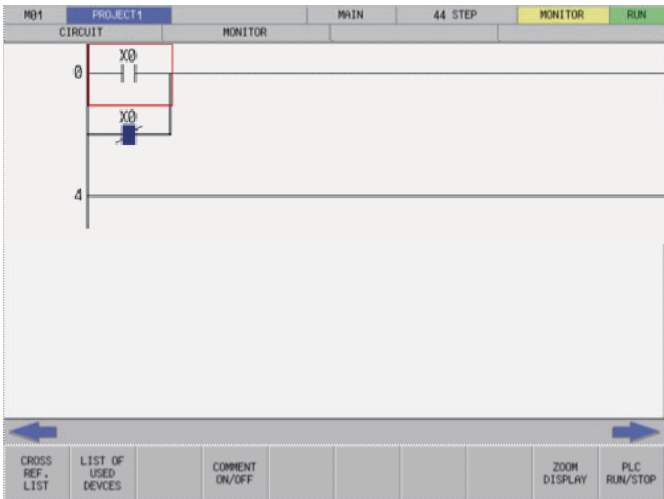
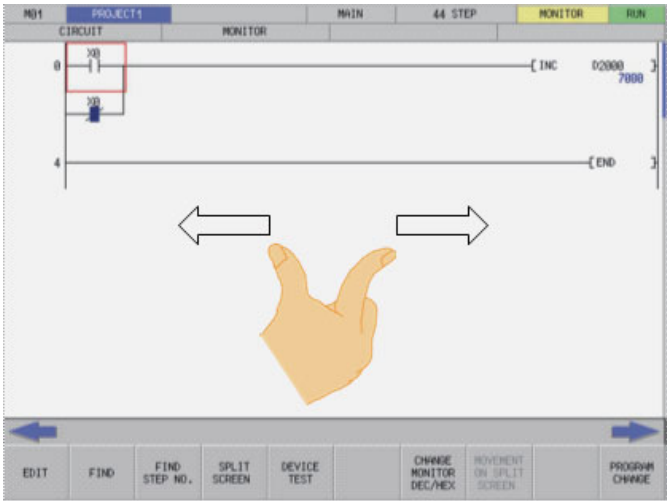

6.5 Language

6.5.1 Screen Display Language

The following table describes the effect of the different NC language parameter settings on the display of text strings, error messages, device names and instructions on ladder screens, and monitor values described in the various controls displayed by the PLC On-board.

The following table describes the timing at which additional languages can be changed.

Timing to change additional languages
Startup and display of the PLC On-board after changing the language parameter

Language parameter	Screen additional languages
0: English	Displays text strings on screens in English.
1: Japanese	Displays text strings on screens in Japanese.
22: Chinese (simplified)	Displays text strings on screens in Chinese (simplified).
11: German 12: French 13: Italian 14: Spanish 15: Chinese (traditional) 16: Korean (Hangul) 17: Portuguese 18: Dutch 19: Swedish 20: Hungarian 21: Polish 23: Russian 24: Turkish 25: Czech 31: Indonesian 32: Vietnamese	Displays text strings on screens in English.

6.5.2 Language for Device Comments, Statements, Notes, and Machine Names

Device comments, statements, notes, and machine names are displayed in the language selected by the language parameter.

Language parameter	Additional languages
0: English	Device comments, statements, notes, and machine names written in English are displayed. Languages other than English may not be displayed correctly.
1: Japanese	Device comments, statements, notes, and machine names written in Japanese are displayed.
22: Chinese (simplified)	Device comments, statements, notes, and machine names written in Chinese (simplified) are displayed.
11: German 12: French 13: Italian 14: Spanish 15: Chinese (traditional) 16: Korean (Hangul) 17: Portuguese 18: Dutch 19: Swedish 20: Hungarian 21: Polish 23: Russian 24: Turkish 25: Czech 31: Indonesian 32: Vietnamese	Device comments, statements, notes, and machine names written in English are displayed. Languages other than English may not be displayed correctly.

6.5.3 Precautions for Language Setting for GX Works2 Project

When using a GX Works2 project, set the same language to project language setting on GX Works2 setting screen and language setting of the project.

Select "Tools" - "Language Selection" from GX Works2 menu to set project language. Select a language from the list box and press "Yes" in the following screen.

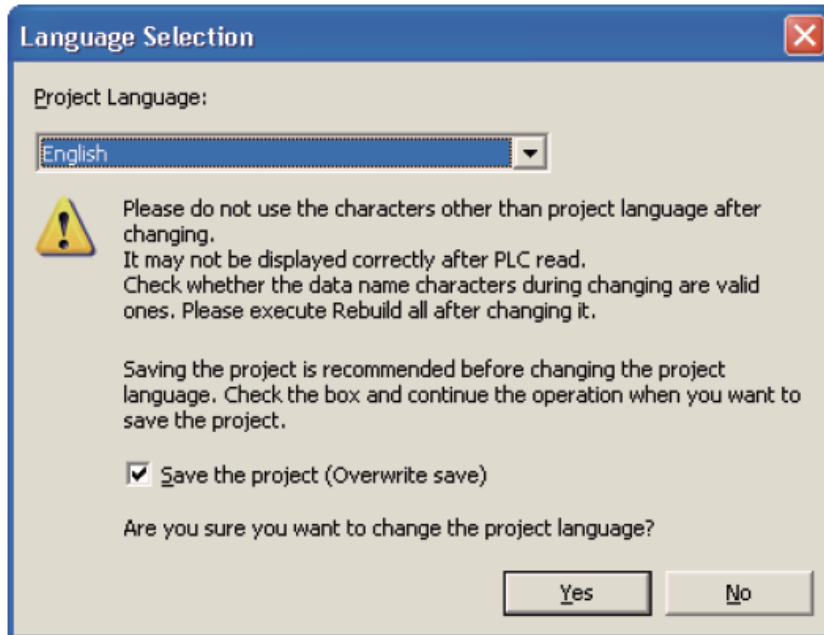

For the project language setting on GX Works2 setting screen, refer to "6.16.4 GX Works2 Setting Screen"

PLC data read error

PLC data read error may occur when the project language setting and project language setting on GX Works2 setting screen do not match. When the following error message is displayed, set the project language setting on GX Works2 setting screen to the same language as the project language, and read again.

Processing suspended: language settings do not match.
Set project language setting on GX Works2 settings screen to language at creating ladder.

Corruption of Device Comment

Device comments may be corrupted when CNC language parameters do not match project language settings. Set the CNC language parameter to be the same as that of project language.

External file operation

Corrupted device comments may be stored when external file is operated while CNC language parameters do not match project language settings. Match the project language setting and project language on GX Works2 setting screen, then operate an external file again.

6.6 PLC Data

6.6.1 PLC Data Used by the PLC On-board

The PLC On-board uses the same data as GX Developer/GX Works2 as illustrated in the following table.

Data type	Data name	Application
Sequence programs	Data names are configured by up to eight one-byte uppercase alphanumeric characters.(*1)	The user PLC, statements, and notes are stored.
PLC messages	Data names are configured by up to eight one-byte uppercase alphanumeric characters (*1) and in accordance with PLC message naming conventions (*3).	PLC messages (alarms, operators, PLC switches, and comments) are stored.
Symbolic information	Parameter names are fixed and cannot be changed.	Store sequence programs and PLC messages of the project with labels or structured project.
Device comments	Data names are configured by up to eight one-byte uppercase alphanumeric characters.(*1)	Comments and device names are stored.
Parameters	Parameter names are fixed and cannot be changed.	Program execution sequences and such are stored.
Trace files	Data names are configured by up to eight one-byte uppercase alphanumeric characters.(*1)	The trace conditions and results are stored.
CSV files	Data names are configured by up to eight one-byte uppercase alphanumeric characters.(*1)	The trace results are stored in CSV file format.

(*1) Characters that cannot be used in data names

- Reserved characters (AUX, CON, PRN, NUL, COM1 to COM9, LPT1 to LPT9, and CLOCK\$)
- Data names that include these characters result in error: ", =, |, :, ;, ,, \, [,], +, *, ?, <, >, . and /

The following characters also cannot be used.

- Special NEC selected IBM extended characters (character codes: 0xED40 to 0xEEEC)
- IBM extended characters (character codes: 0xFA40 to 0xFC4B)
- Characters of character codes that have the same appearance as NEC selected IBM extended characters and IBM extended characters within the range of character codes 0x849F to 0x879C

Example: Roman numerals (I to X), ≡, ≅, ∫, ∫, ∑, √, ⊥, ∠, ∠, ∴, ∩, ∪, №, ™, and (株).

If any of these characters are used, processing that uses PLC data (opens, saves, etc.) will not execute correctly.

(*2) Characters that can be used to set data names

Alphanumeric characters, Kana (Japanese syllabaries), Chinese characters, and these characters: _, ^, \$, ~ (tilde), !, #, %, &, (,), -, {, }, @ and '.

(*3) Use the following method to change names of PLC message data.

- Specify bits 0-2 (3 bits) of bit selection parameter #6453 (Language selection method using only the PLC).

Data type	Data name	Details of data
Program	M1xxxxxx	PLC message in the 1st language
	:	
	M7xxxxxx	PLC message in the 7th language
	M8xxxxxx	PLC message in the 8th language

- Specify with the display language selection parameter (Base specification parameter #1043 (Method linked with language selection on the setting and display screens)).

Data type	Data name	Details of data
Program	M00xxxxxx	PLC messages for language parameter 0 (English)
	M01xxxxxx	PLC messages for language parameter 1 (Japanese)
	:	
	M25xxxxxx	PLC messages for language parameter 25 (Czech)

6.6.1.1 Sequence Program Details

The following details for created data can be saved as program data.

Saved details	Outline
Program (ladder) circuits	This is data used to edit and monitor the user PLC with following ladder diagrams. 
Statements	Statements are text strings added to each program ladder block to make it easier to understand the flow of the entire program. Statements include integrated statements that can be stored in the NC and peripheral statements that cannot be stored in the NC.(*1)
Notes	Similar to statements, notes are text strings added to each coil and function instruction in the program ladder to make it easier to understand the flow of the entire program. Notes include integrated notes that can be stored in the NC and peripheral notes that cannot be stored in the NC.(*1)

(*1) Integrated statements, notes, and peripheral statements

Integrated type	Integrated types can be saved in the NC. Note that the program data takes up a large amount of memory when stored in the NC.
Peripheral types	Peripheral types are deleted when saved to the NC. For this reason, when using peripheral statements or notes, they must be managed as GX Developer/GX Works2 projects. Peripheral types are also stored to symbolic information when using project with labels or structured project with GX Works2. For this reason, when symbolic information is stored, it is displayed on PLC on-board.

6.6.1.2 PLC Message Details

The following table lists the PLC message types.

Saved details	Outline
Alarm message	PLC alarm messages displayed on the NC.
Operator messages	PLC operator messages displayed on the NC.
PLC switches	Text strings used to name PLC switches.
Comment messages	PLC comment text strings displayed on the NC.

6.6.1.3 Device Comment Details

The following table lists the device comment types and details.

Saved details	Outline
Device comments	Text string data added to each device. Programs are easier to understand when comments are assigned to the devices.(*1)
Aliases	These text strings are displayed in place of the device name. These text strings make it easier to visually distinguish between programs.(*2)

(*1) GX Works2 project can have device comment in bit units of word device.

(*2) Device comments of GX Works2 project do not include device names.

6.6.1.4 Parameter Details

The following table lists the parameter types and details.

Saved details	Outline
Program settings	These are execution sequences for multiple programs (ladders).
Common pointer settings	These are numbers placed at the beginning of common pointers.

6.6.1.5 Trace File Details

The following details can be saved as the trace file.

Saved details	Outline
Trace conditions	Sampling trace conditions such as the number of trace times, trace points, trigger points, trace data, etc.
Trace results	Trace data of the bit device and word device.

6.6.1.6 CSV Format File Details

The following detail can be saved in CSV format.

Saved details	Outline
Trace results	Trace data of the bit device and word device stored in CSV format.

6.6.2 PLC Data Storage Areas

PLC data used by the PLC On-board is stored in the following locations.

Storage area	Application
Temporary memory area	This area stores data used to execute the PLC. This data is editable with the PLC On-board and GX Developer/GX Works2 but is deleted when power to the NC is turned off.
Internal ROM area	This area stores the PLC data. The data in this area is not lost when the power to the NC is turned off. <Note> • The data in the temporary memory is lost when power to the NC is turned off, so always save the data in the internal ROM area.
On-board editing area	This area is used when editing and monitoring the PLC data with the on-board. When editing or monitoring, open the PLC data that is in the temporary memory into the on-board editing area.
Execute area	This area stores the programs executed during PLC RUN.
External devices (SD cards/USB memory)	PLC data can be read from external devices to the on-board editing area and the temporary memory area. GX Developer/GX Works2 project can be read. Only the project with operation mode that matches the project operation mode of PLC on-board can be read. For details on the "Operation mode", refer to "6.1.3 Operation Mode of Project".

[Configuration diagram of the PLC data storage areas]

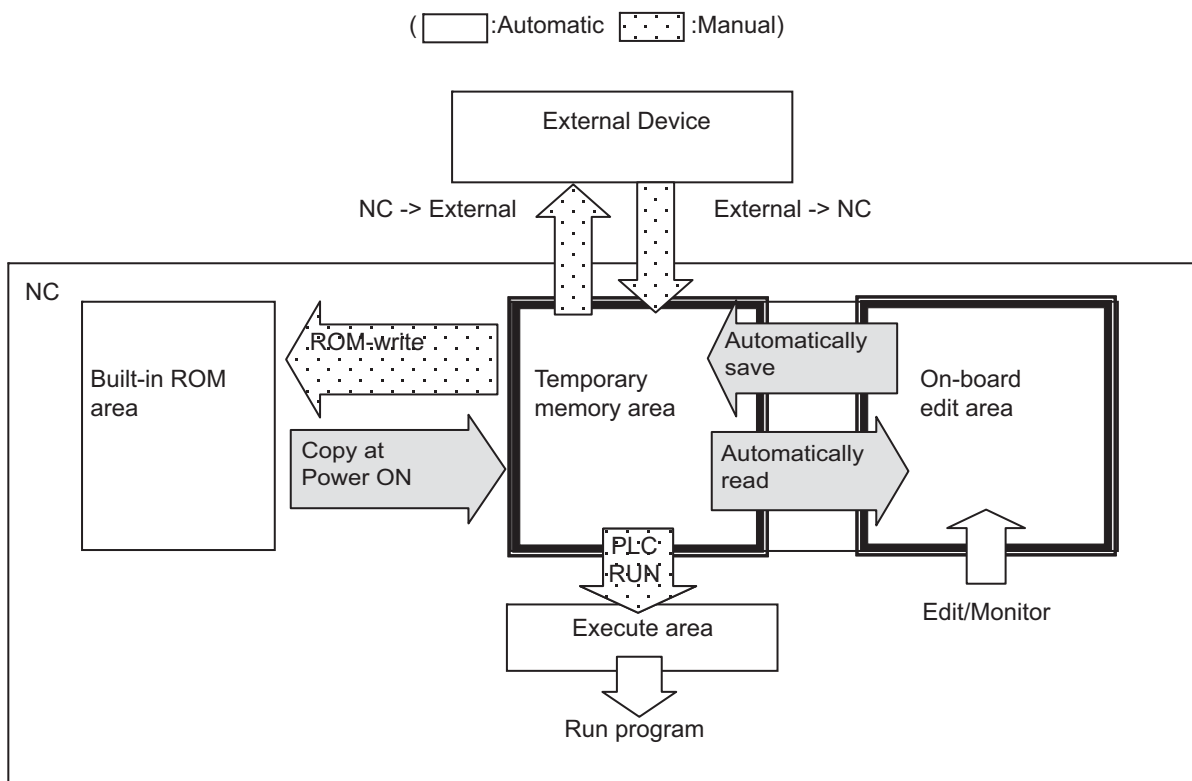

6.6.2.1 Readable PLC Data with PLC On-board

The table below shows the size and number of programs of the PLC data which can be handled by CNC.

Models	M800VW	M800VS	M80VW	M80V TypeA	M80V TypeB
Maximum number of programs	120 programs	120 programs	60 programs	60 programs	60 programs
Maximum number of steps	128 K (256 K/512 K (*1))	128 K (256 K/512 K (*1))	64 K	64 K	32 K
Data capacity	8 MB	8 MB	2 MB	2 MB	2 MB

(*1) 256 K steps and 512 K steps are the optional specifications.

When the PLC data is edited using the on-board with the M800VS Series or M80V Series, PLC data may not be read due to the restriction of memory capacity even if the data size is within the range described above. To edit the PLC program using the PLC on-board, make the total size of device comments less than 1 MB.

When the data is too large to be stored in the editing memory of the PLC on-board, an error message appears when the data is read. The data which has been read can be displayed and edited. However, some data has not been read in such a case; therefore, it is not suitable for checking the operation of the sequence program. Use GXWorks2 to check the operation of the sequence program of the data which causes an error when the data is read into PLC on-board.

6.6.2.2 The Number of Ladder Files and PLC Message Files Available on One Project

Maximum number of ladder files and PLC message files available on one project is as follows: number of ladder files + number of PLC message files < 125. (The 125th and subsequent files cannot be read.)

If the total of ladder files and PLC message files exceeds 125, develop the project in either of the following methods:

- Read only the necessary PLC message files to the PLC on-board. (PLC message files are not read automatically when you start PLC on-board. Thus select [NC FILE] - [OPEN] to read them.)
- Use the multi-project function to set the number of files per project to 124 or less.

6.6.2.3 Handling of PLC Data during External File Operation

When there is already a PLC data in a target destination while operating an external file, operation differs depending on the operation target project.

Refer to "6.14 External File Operation Menus" for the operation method.

External -> NC (GX Developer project)

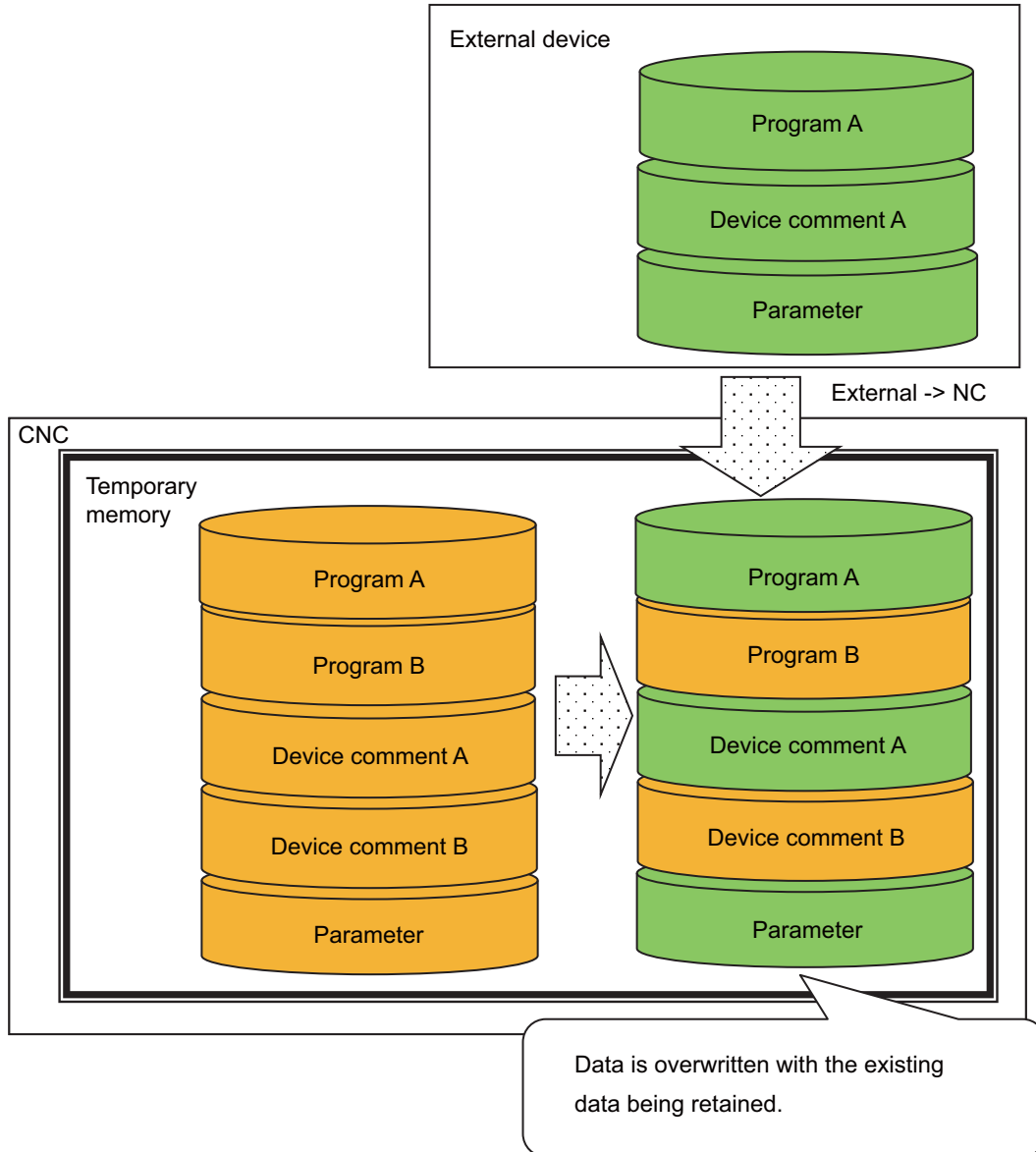

External -> NC (GX Works2 project)

- When storing a project without labels while a project with labels is stored in temporary memory area.

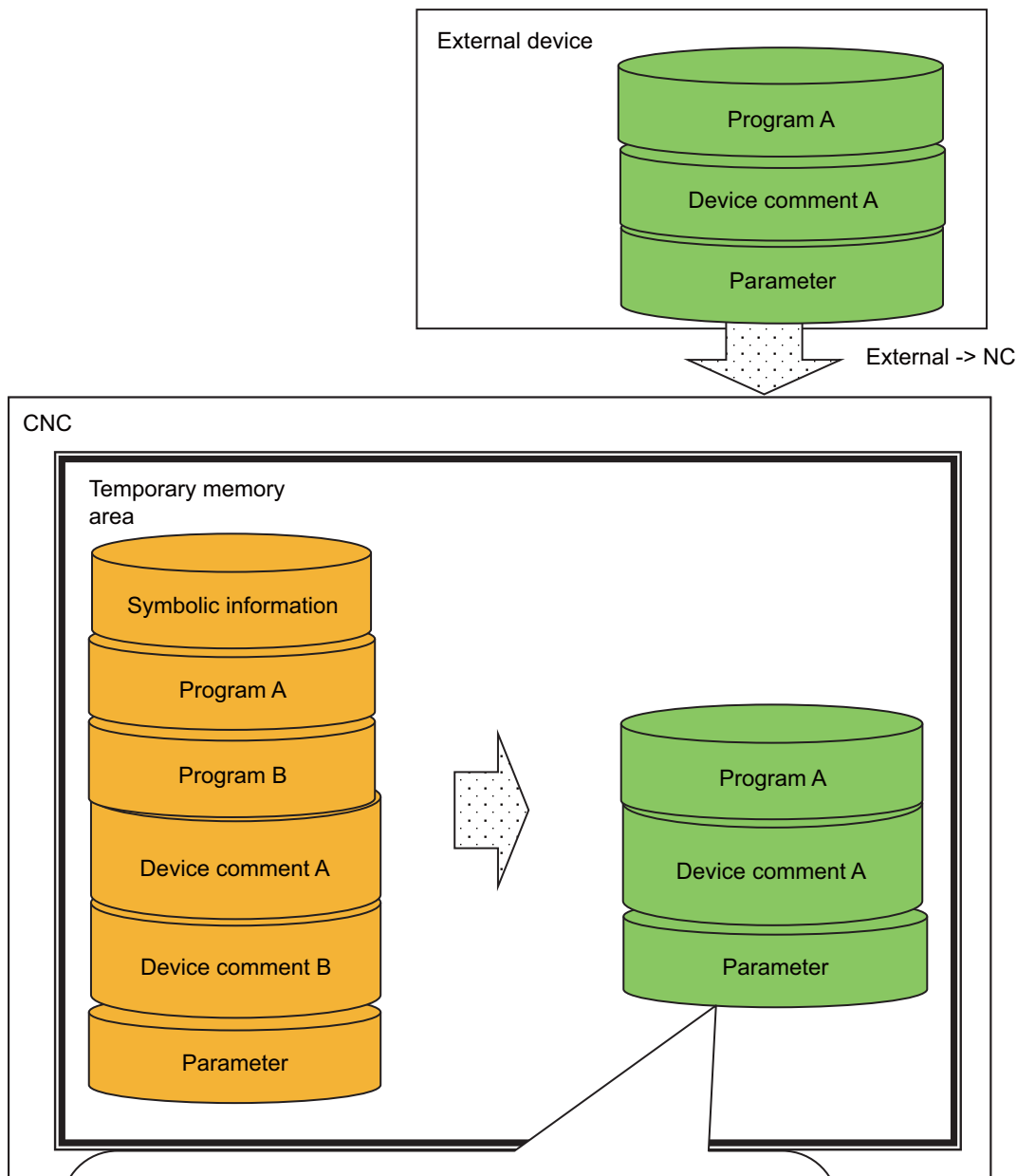

All the existing data in the CNC before writing is deleted and replaced with the data of the external device.
 For GX Works2 format projects, programs (symbolic information) and parameters are always selected for data to be stored. Device comments can be selected individually.

External -> NC (GX Developer project)

- When a project with the same name exists in the target destination of external device.

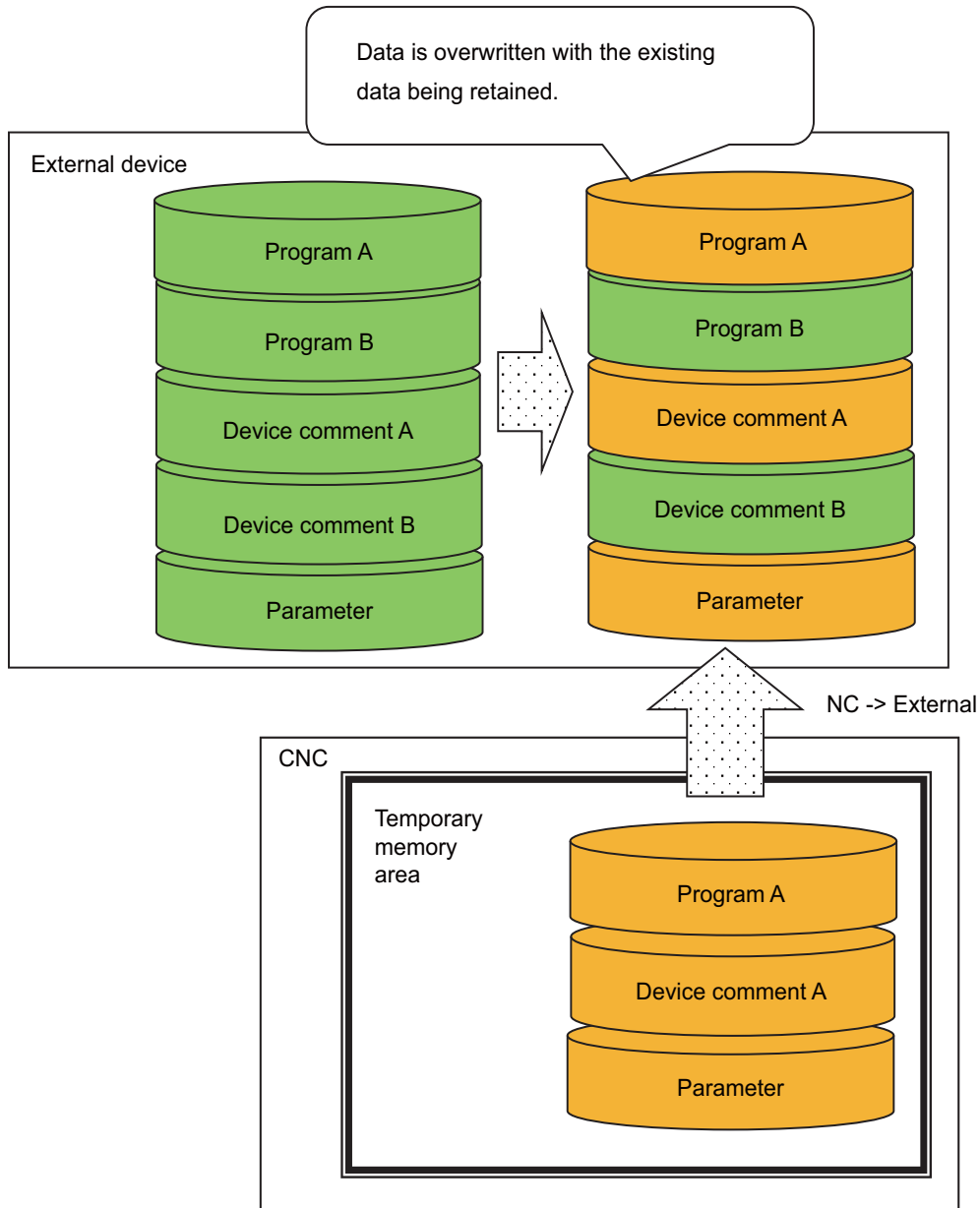

NC -> EXT (GX Works2 project)

- When a project with the same name exists in the target destination of external device.

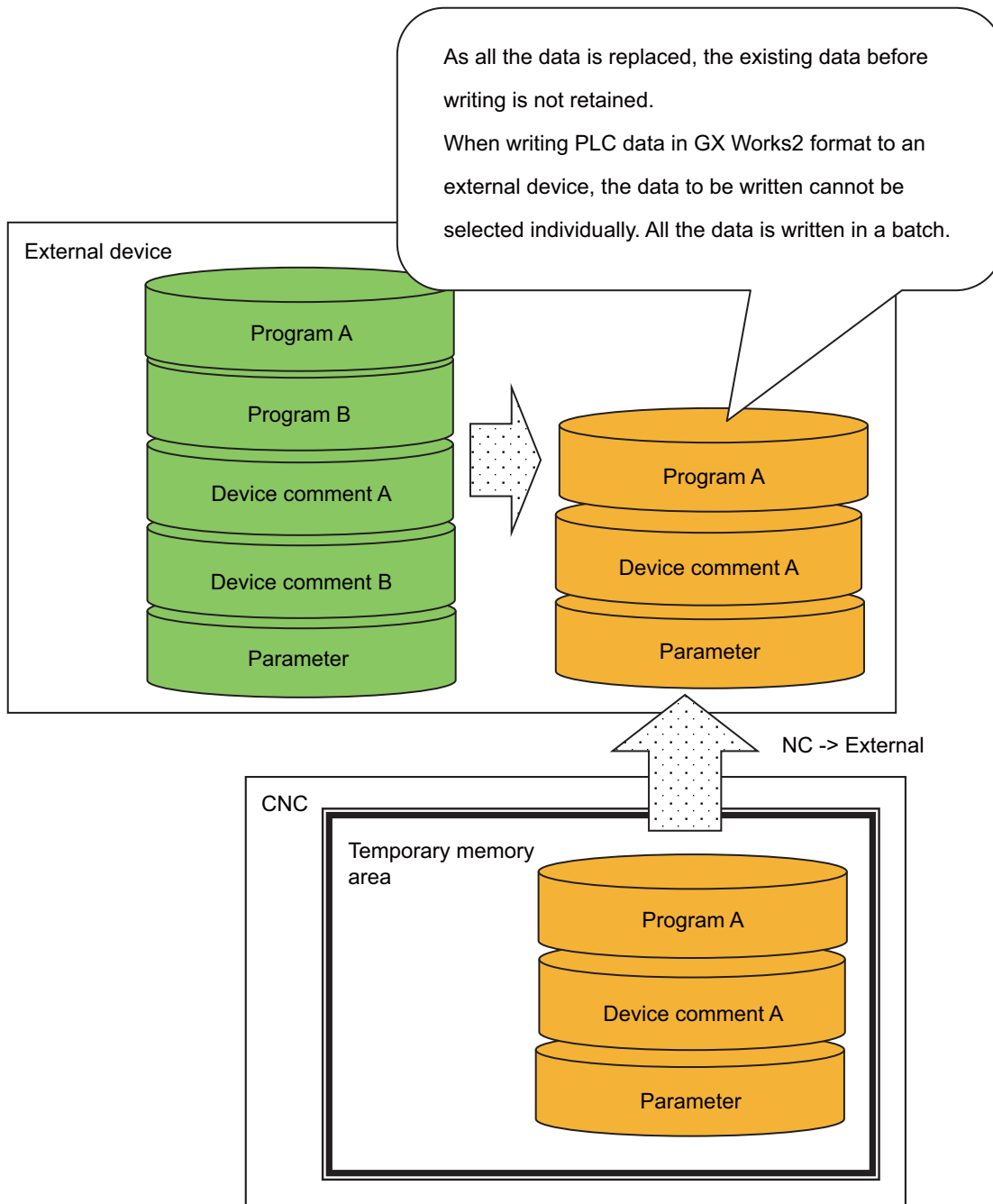

6.6.2.4 Number of Files Storable

Storage capacity of PLC data is as follows: The number is the total of all the projects.

Data category	Number of files storable		Remarks
	M80V	M800V	
Parameter	6 pcs		1 pc for each project
Program	60 pcs	120 pcs	
PLC Messages	80 pcs		Total number of data
Device comments			
Symbolic information (" Number of symbolic information")			

Number of symbolic information

Number of symbolic information differs depending on how to be stored in CNC.

■ When writing operation to the PLC with GX Works2

Number of symbolic information is 2 when writing method is "High Speed Mode" and 1 when it is "Compatible mode".

The following are the procedures to set writing method of symbolic information.

- (1) Select [Tools] - [Options] in GX Works2.
- (2) Select "Symbolic Information" on an option screen.
Set on "System information write settings to PLC".

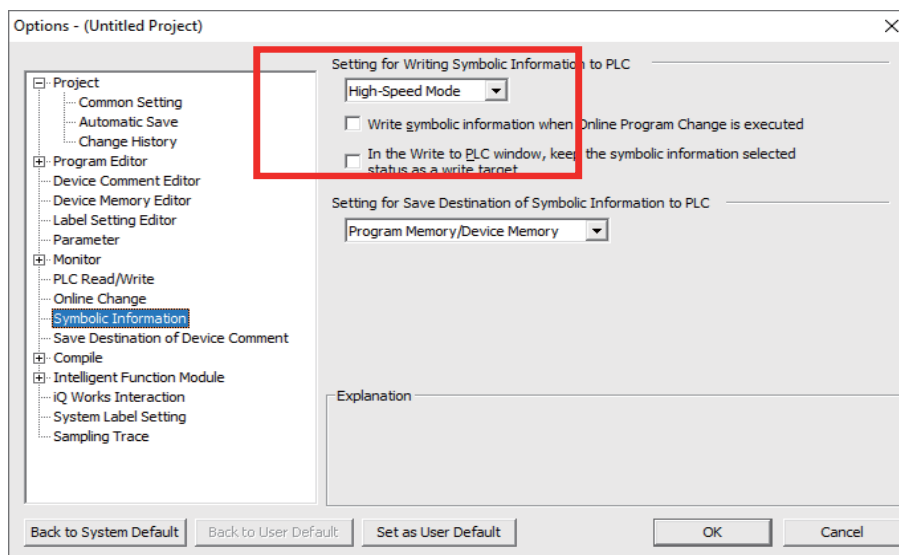

■ When using "External -> NC" of PLC on-board

Number of symbolic information is 2.

6.6.3 Passwords for PLC Data

Passwords are set on some PLC data to protect PLC data.

Password that can be used with PLC on-board are as follows:

Password type	Target	Attribute	Number of characters	Character that can be set	Reference
File password	For each file <ul style="list-style-type: none"> • Program • PLC Messages • Device comments 	Writes not allowed Reads and writes not allowed	4	One-byte numeric character One-byte numeric character (uppercase) One-byte numeric character (lowercase)	6.6.3.1 Passwords for PLC Data Files
Block password	For each POU <ul style="list-style-type: none"> • Program block • Function block 	Read and writes not allowed	6 to 32	One-byte numeric character One-byte numeric character (uppercase) One-byte numeric character (lowercase) Half-width space One-byte symbols(*1)	6.6.3.2 Block Passwords for PLC Data

(*1) Usable symbols

!"#\$%&'()*+,-./:;<=>?@[\]~

Do not use the symbols "@", "^", " ", " ", and " | " because they may not be input with PLC on-board although they can be used with GX Works2.

6.6.3.1 Passwords for PLC Data Files

A file password is set for each file in PLC data.

A file password for PLC data stored in the NC can be temporarily cleared by the PLC on-board.

Note

(1) PLC on-board cannot be used to register, change, or delete file passwords.

Use GX Developer (for a project created with GX Developer or PLC on-board) or GX Works2 (for a project created with GX Works2) to operate.

Refer to "5.12 File Password Function" for GX Works2.

File password attributes

File passwords have write attributes (writes allowed/not allowed) and read attributes (reads allowed/not allowed). The following table describes the operation restrictions corresponding to these attributes.

Attribute	Restricted operation
Writes not allowed	PLC data cannot be overwritten, deleted or changed after editing circuits.
Reads and writes not allowed	In addition to the preceding restrictions, PLC data cannot be read or viewed.

Clearing file passwords

As illustrated in the following table, the screen used to cancel passwords is displayed in accordance with the proper matching of operations performed and file attributes marked with "Yes" in the [Attribute criteria].

Data protection mechanisms can be temporarily cleared by entering the password on the screen.

Operations		Attribute criteria		
		Writes not allowed	Reads and writes not allowed	
NC File Operation ->	Open -> Close	-	○	
	File Operation ->	Delete Data -> Delete	○	○
		Rename Data name -> Change	○	○
	Password Cancellation	Not relevant		
	PLC Version up	○	○	
External File Operation ->	External -> NC -> Execute	○	○	
	NC -> External -> Execute	-	○	
	Verify External File -> Execute	-	○	
	Password Cancellation	Not relevant		
Edit ladder -> Perform edits -> Change		○	○	

Refer to "6.21 Canceling File Passwords" for information on clearing file passwords.

Valid period of file password clears

File passwords are cleared until the following operation is executed.

- Returning to the password not entered state (Refer to " Locking the password for all data")
- Starting PLC on-board again
- Changing the connection project

Passwords do not need to be entered again when reading PLC data again or overwriting PLC data for which passwords have been cleared.

Passwords must be entered again and cleared when passwords for PLC data are changed in GX Developer/GX Works2.

Precautions for file password setting

If you forget or rewrite the password, refer to "5.12 File Password Function".

File password of project with labels and structured project

When using a project with labels or a structured project, some PLC data such as sequence program is read/written in a file, symbolic information. Even when there is one file with uncanceled password in symbolic information, operation according to the set file password is limited.

File passwords to read PLC data from external device to NC

File password setting in CNC differs depending on operation mode when reading PLC data from external device to CNC. A file password is temporarily unlocked after reading.

■ When operation mode is GX Developer

A file password of external device PLC data overwrites those of projects in CNC.

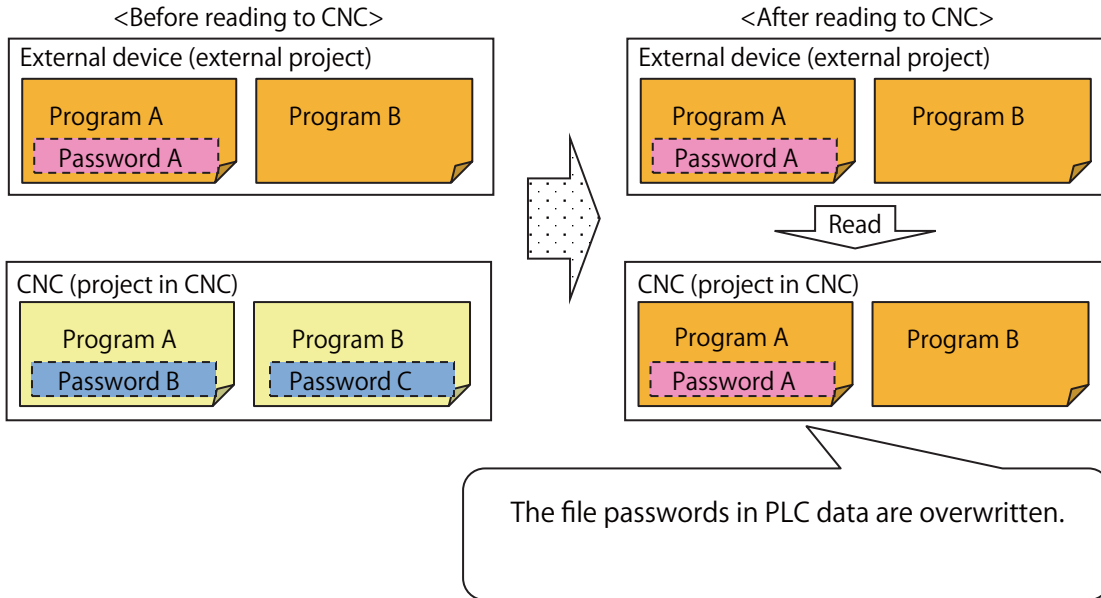

■ When operation mode is GX Works2

Since GX Works2 project of external device does not have a file password, file passwords set in files in CNC before reading are maintained.

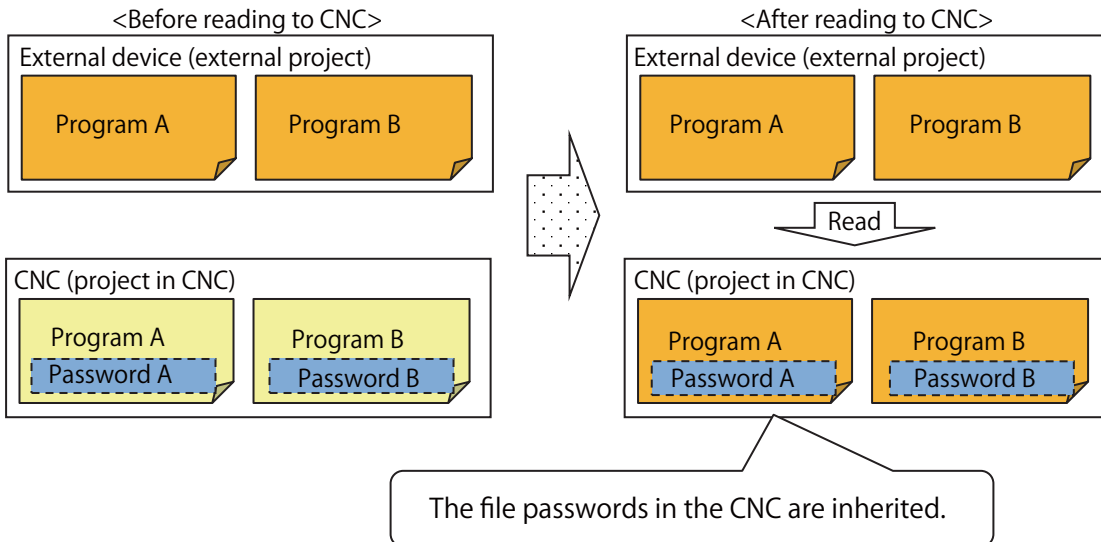

Even when reading PLC data of project with different project type from CNC project (simple project with labels, simple project without labels, structured project), a file password of the same file name is maintained.

To read without inheriting file password for GX Works2, read either after executing CNC format (refer to "6.13.8 Format Popup Screen") or after erasing file password.

6.6.3.2 Block Passwords for PLC Data

Block password is set for each POU such as FB when PLC data is a project with labels or a structured project. Block password can be temporarily unlocked as file password for PLC on-board.

Note

(1) PLC on-board cannot be used to register, change, or delete file passwords.

Perform the following operations on GX Works2. Refer to "GX Works2 Operating Manual (Common)" and "GX Works2 Operating Manual (Simple Project)".

Block password attribute

Block password can be set only for reading/writing. Prohibited operations are as follows:

Attribute	Restricted operation
Read and writes not allowed	Find POU, Display of FB instance monitor Ladder display of program block

Block password cancel method

By the following operations, "Password cancellation" screen is displayed.

Data protection mechanisms can be temporarily cleared by entering the password on the screen.

Operations	Block password cancel
POU screen	Block Password Disable ○
Monitor ladder	Find ×
	FB Instance Monitor ○
	Switch Program ○

Valid period of block password clears

Block passwords are set for POU. When clearing a block password cancels all block passwords of instance that use the same POU.

Block password is cleared until the following operation is executed.

- Returning to the password not entered state (Refer to "Returning to the block password not entered state method")
- Opening CNC symbolic information again
- Changing the connection project

Password cleared state is maintained until the symbolic information is open again even when the block password set to the CNC POU is changed with GX Works2. Changed block password is valid after reopening CNC symbolic information.

Returning to the block password not entered state method

The following operations can return the block password not set state.

	Operation
NC file operation ⇒	Open -> Open
	"PASSWORD CANCELLATION" popup screen ⇒ PWD lock for all data
	File List ⇒ POU ⇒ PWD lock for all data
External File Operation ->	External -> NC -> Execute
	"PASSWORD CANCELLATION" popup screen ⇒ PWD lock for all data

6.6.3.3 Simultaneous Connection of PLC on-board and GX Developer/GX Works2

Do not connect PLC on-board and GX Developer/GX Works2 simultaneously.

The operation for PLC data in the NC if reading and writing are performed with GX Developer/GX Works2 and PLC on-board simultaneously cannot be guaranteed.

The monitor function such as circuit monitor can be used simultaneously.

6.7 Starting

6.7.1 Starting the On-board

There are two methods used to start the PLC On-board.

■ Start from the Mitsubishi Electric standard screen

There is a [Ladder Monitor] menu on the save screen in the Mitsubishi Electric standard screen. (area inside the red lines in the following diagram)

Selecting this menu starts the PLC On-board and displays the main screen.

Mainte	Param	I/O						
Screen	Console	Open	Open			Ladder		HMI
size	exec	dev par	SRAM			Monitor		Quit

■ Start by pressing the [F0] key

Pressing the [F0] key when the bit selection parameter that enables the PLC On-board is set starts the PLC On-board and displays the main screen.

6.8 Ending the PLC on-board and Transitioning to the Mitsubishi Electric Standard Screen

6.8.1 Ending the PLC On-board

There is no end menu in the PLC on-board. For this reason, to end the PLC on-board, transition to the Mitsubishi Electric standard screen or turn OFF the power to the NC.

6.8.2 Transitioning to the Mitsubishi Electric Standard Screen

6.8.2.1 Method to Transition to the Mitsubishi Electric Standard Screen

The following table describes the method used to transition from the PLC on-board to the Mitsubishi Electric standard screen.

Method to transition to the Mitsubishi Electric standard screen
Press the [MONITOR], [SET UP], [EDIT], [DIAGN], or [MAINTE] key on the NC hardware keyboard to transition to the screen corresponding to the Mitsubishi Electric standard screen.
Press the [OPERATE], [ARRANGE], [EDIT], [DIAGNOSIS], or [SAVE] key on the PLC on-board software keyboard to transition to the screen corresponding to the Mitsubishi Electric standard screen.

6.9 Precautions when Using a Project with Labels

6.9.1 Compatible Types

A project with labels can be used only on the Windows-based models such as M800VW series and M80VW series.

6.9.2 Compatible Project Type

Only a project with labels created with GX Works2 can be used with PLC on-board. A project created with GX Developer cannot be used. Refer to "6.1.1 List of Project" for details.

6.9.3 Function

For details of functions that can be used in a project with labels, refer to "6.1.2 List of Function".

6.9.4 File Password

A project with labels reads/writes in one file, symbolic information and some specifications differ from those of a project without labels. Refer to "File password of project with labels and structured project" for details.

6.9.5 Compatible POU

The following table describes POU supported by a project with labels.

POU	Function		
	POU List	Monitor ladder	Ladder searching
Program	○	○	○
Function block	○	○ (*1)	○ (*2)
Inline Structured Text Box	×	×	×

(*1) When the FB is created in a program language which cannot be displayed, it can be displayed and monitored in the source ladder. Descriptions of the FB cannot be displayed.

(*2) When the FB is created in a program language which cannot be displayed, it cannot be searched.

6.10 Precautions when Using a Structured Project

6.10.1 Compatible Types

Install a MELSOFT software to Windows to use a structured project with PLC on-board. A structured project can be used only with Windows mounted type.

6.10.2 Function

For functions that can be used in a structured project, refer to "6.1.2 List of Function".

6.10.3 File Password

A structured project reads/writes in one file, symbolic information and some specifications differ from those of a project without labels. Refer to "File password of project with labels and structured project" for details.

6.10.4 Compatible POU

The following table describes POU supported by a structured project.

POU		Function		
		POU List	Monitor ladder	Ladder searching
Program block		○	○	○
Function block		○	○ (*1)	○ (*3)
Function		○	x	x
Inline Structured Text Box		x	x	x
User Library	Program Block	○	x	x
	Function block	○	△ (*2)	x
	Function	○	x	x

(*1) When the FB is created in a program language which cannot be displayed, it can be displayed and monitored in the source ladder. Descriptions of the FB cannot be displayed.

(*2) The FB of user library is displayed and monitored in the source ladder. Descriptions of the FB of user library cannot be displayed.

(*3) When the FB is created in a program language which cannot be displayed, it cannot be searched.

6.10.5 Program Block with Program Setting Unset

A program block with program setting unset can display ladder monitor, but has limitations on monitor and device test.

	Monitor	Device test
Device	○	○
Local label	x	x
Global label	x	○ (*1)
FB instance	○	-

(*1) On a program block with program setting unset, monitor cannot be executed and change cannot be confirmed.

6.11 Basic Operation

This section describes the basic operational procedures to use the PLC on-board. Refer to the operational procedures for each screen (described later) for information on operating specific screens.

6.11.1 Basic Operation 1 (Configuring Multiple Project Parameters)

The following information describes the configuration procedure when using multiple projects.

6.11.1.1 Cases in which Sequence Programs are not Stored

If the sequence programs are not stored, the menu key used to configure multiple project parameters is displayed on the main screen.

The NC must be restarted to update the multiple project parameter configuration.

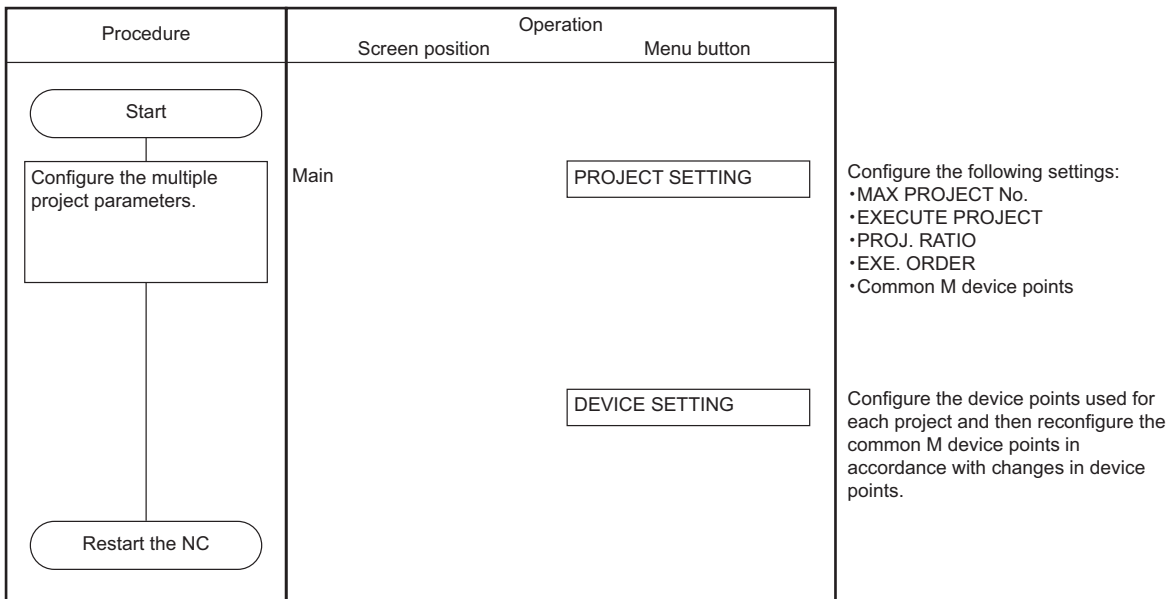

6.11.1.2 Cases in which Sequence Programs are Stored

If the sequence programs are stored in the NC, use the following procedure to configure the multiple project parameters.

Procedure	Operation
(1)	Back up the sequence program. (*1)
(2)	Format the temporary storage area in the CNC.
(3)	Write PLC data stored in the temporary storage area of the CNC to ROM.
(4)	Configure the multiple project parameters.



(*1) When backing up the program, it is saved with the data format according to the project operation mode (GX Developer, GX Works2). For setting method of operation mode, refer to " Operation mode settings".

When operation mode is GX Works2, the program is saved in one file format.

Backing up the sequence programs

An external device such as an SD card or USB memory is required to backup sequence programs. Perform these operations after mounting an external device.

To use only one project

Procedure	Operation		
	Screen position	Menu button	
Start	After the PLC on-board starts, the system automatically reads PLC data and transitions to the ladder screen. The monitor also starts.		
Return to the main screen.	Ladder		
PLC data stored in the NC is stored in external devices.	Main	EXT. FILE OPERATION	
	Main/External file operation	NC -> EXT.	
	Main/External file operation/NC -> External	SELECT/CANCEL	Select the data to back up.
		WRITE	The save external project screen displays.
	Save external project	PATH	Enter the [Project Name], [Title], and [Path] used to store the backup PLC data.
PROJECT NAME			
TITLE			
SELECT		Run the [Select] operation after entering the path.	
Return to the main screen.	Main/External file operation		Return to the main screen.
Complete			

To use multiple projects

Procedure	Operation		
	Screen position	Menu button	
Start			
Select the current project.	Main	SELECT PROJECT	Select the current operation project.
Store the PLC data stored in the current project into an external device.	Main	EXT. FILE OPERATION	
	Main/External file operation	NC -> EXT.	
	Main/External file operation/NC -> External	SELECT/CANCEL	Select the data to back up.
	Save external project		WRITE
		PATH	Enter the [Project Name], [Title], and [Path] used to store the backup PLC data.
		PROJECT NAME	
		TITLE	
	SELECT	Run the [Select] operation after entering the path.	
Return to the main screen.	Main/External file operation		Return to the main screen.
Complete			Repeat this procedure until all PLC data stored in all projects is backed up.

6.11.2 Basic Operation 2 (Creating Your First Program)

If the sequence programs are not stored in the NC, follow the sequence of operations as described in the following table to create your first sequence program.

Procedure	Operation
(1)	Create a new sequence program
(2)	Edit the sequence program
(3)	Monitor the sequence program

Project without labels can be created.

A new program can be created and edited only when the operation mode is GX Developer. For setting method of operation mode, refer to "Operation mode settings".

When the operation mode is GX Works2, create or edit a project with GX Works2, then store to CNC with external device. Refer to "6.11.5 Basic Operation 5 (Loading Programs Created with GX Developer/GX Works2)" for the operation method of external device.

6.11.2.1 Adding New Sequence Programs

The following diagrams illustrate the procedure to add new sequence programs.

To use only one project

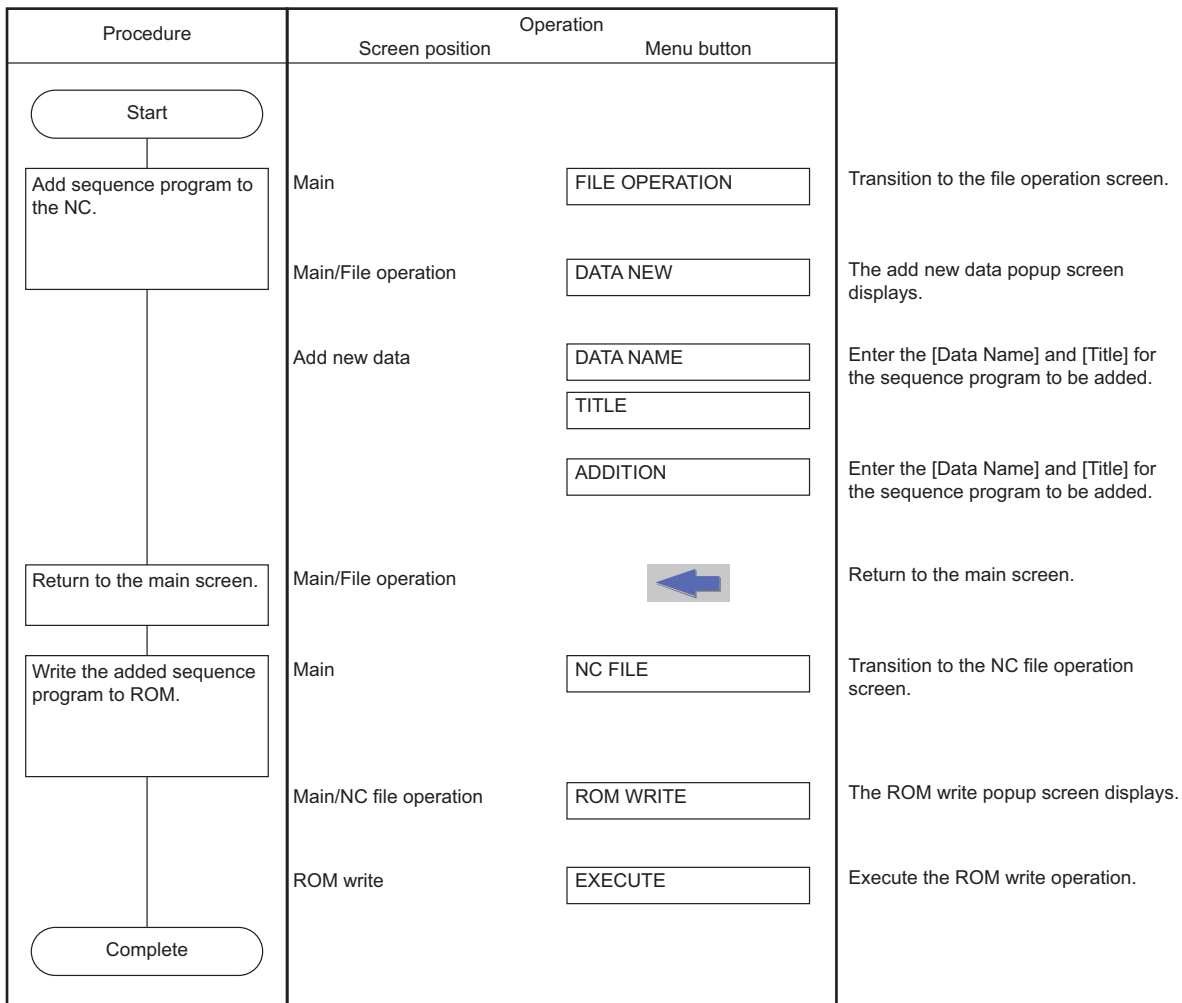

To use multiple projects

Procedure	Operation		
	Screen position	Menu button	
Start			
Select the current project.	Main	SELECT PROJECT	Select the current operation project.
Add the sequence program to the current project.	Main	FILE OPERATION	Transition to the file operation screen.
	Main/File operation	DATA NEW	The add new data popup screen displays.
Return to the main screen.	Add new data	DATA NAME	Enter the [Data Name] and [Title] for the sequence program to be added.
		TITLE	
		ADDITION	Enter the information for the added data and execute the [ADD] operation.
Return to the main screen.	Main/File operation		Return to the main screen.
			Repeat this procedure until the sequence program has been added to all projects.
Write the added sequence program to ROM.	Main	NC FILE	Transition to the NC file operation screen.
	Main/NC file operation	ROM WRITE	The ROM write popup screen displays.
Complete	ROM write	EXECUTE	Execute the ROM write operation.

6.11.2.2 Editing the Sequence Program

The following diagrams illustrate the procedure to edit sequence programs.

To use only one project

Procedure	Operation		
	Screen position	Menu button	
Start			
Display the ladder screen.	Main	LADDER	Transition to the ladder screen.
	Main/ladder	EDIT	Switch to the edit mode.
	Main/ladder	CONVERT LADDER	Create a program. <Ladder sample> M0 P4002 -/ -----[INC D0]- Edited ladder data is confirmed by the conversion operation.
Return to the main screen.	Main/ladder		Return to the main screen.
Write the added sequence program to ROM.	Main	NC FILE	Transition to the NC file operation screen.
	Main/NC file operation	ROM WRITE	The ROM write popup screen displays.
	ROM write	EXECUTE	Execute the write operation.
Complete			

To use multiple projects

Procedure	Operation		
	Screen position	Menu button	
Start			
Select the current project.	Main	SELECT PROJECT	Select the current operation project.
Display the ladder screen.	Main	LADDER	Transition to the ladder screen.
	Main/ladder	EDIT	Switch to the edit mode.
			Create a program. <Ladder sample> MO P4002 - / -----[INC D0]-
	Main/ladder	CONVERT LADDER	Edited ladder data is confirmed by the conversion operation.
Return to the main screen.	Main/ladder		Return to the main screen.
			Repeat this procedure until the sequence program has been stored in all projects.
Write the added sequence program to ROM.	Main	NC FILE	Transition to the NC file operation screen.
	Main/NC file operation	ROM WRITE	The ROM write popup screen displays.
	ROM write	EXECUTE	Execute the ROM write operation.
Complete			

6.11.2.3 Monitor the Sequence Program

The following diagrams illustrate the procedure to monitor sequence programs.

To use only one project

Procedure	Operation		
	Screen position	Menu button	
Start			
Monitor the ladder.	Main	LADDER	Transition to the ladder screen. The monitor automatically starts.
Test the device.	Main/ladder	DEVICE TEST	Display the device test popup screen.
	Device test	BIT DEVICE	Select the bit device input field on the device test popup screen. <Device input example> M0
		SETTING METHOD	Select the setting method selection field. <Selection example> Forced reverse of the ON/OFF state
		SET	Forcibly reverse the ON/OFF state of M0.
Complete			

To use multiple projects

Procedure	Operation		
	Screen position	Menu button	
Start			
Select the current project.	Main	SELECT PROJECT	Select the current operation project.
Monitor the ladder.	Main	LADDER	Transition to the ladder screen. The monitor automatically starts.
Test the device.	Main/ladder	DEVICE TEST	Display the device test popup screen.
	Device test	BIT DEVICE	Select the bit device input field on the device test popup screen. <Device input example> M0
		SETTING METHOD	Select the setting method selection field. <Selection example> Forced reverse of the ON/OFF state
		SET	Forcibly reverse the ON/OFF state of M0.
Return to the main screen.	Main/ladder		Return to the main screen.
			Select the project at the main screen to select a different project to monitor.
Complete			

6.11.3 Basic Operation 3 (Editing Programs Stored in the NC)

If the sequence programs are stored in the NC, follow the sequence of operations as described in the following table to edit the sequence programs.

Procedure	Operation
(1)	Edit and debug the sequence program
(2)	Save the sequence program to the internal ROM

A program is edited only when operation mode is GX Developer. For setting method of operation mode, refer to " Operation mode settings".

When the operation mode is GX Works2, edit a project with GX Works2 with external device, then store to CNC. Refer to "6.11.5 Basic Operation 5 (Loading Programs Created with GX Developer/GX Works2)" for the operation method of external device.

6.11.3.1 Editing and Debugging the Sequence Program

The following diagrams illustrate the procedure to edit and debug sequence programs stored in the NC.

To use only one project

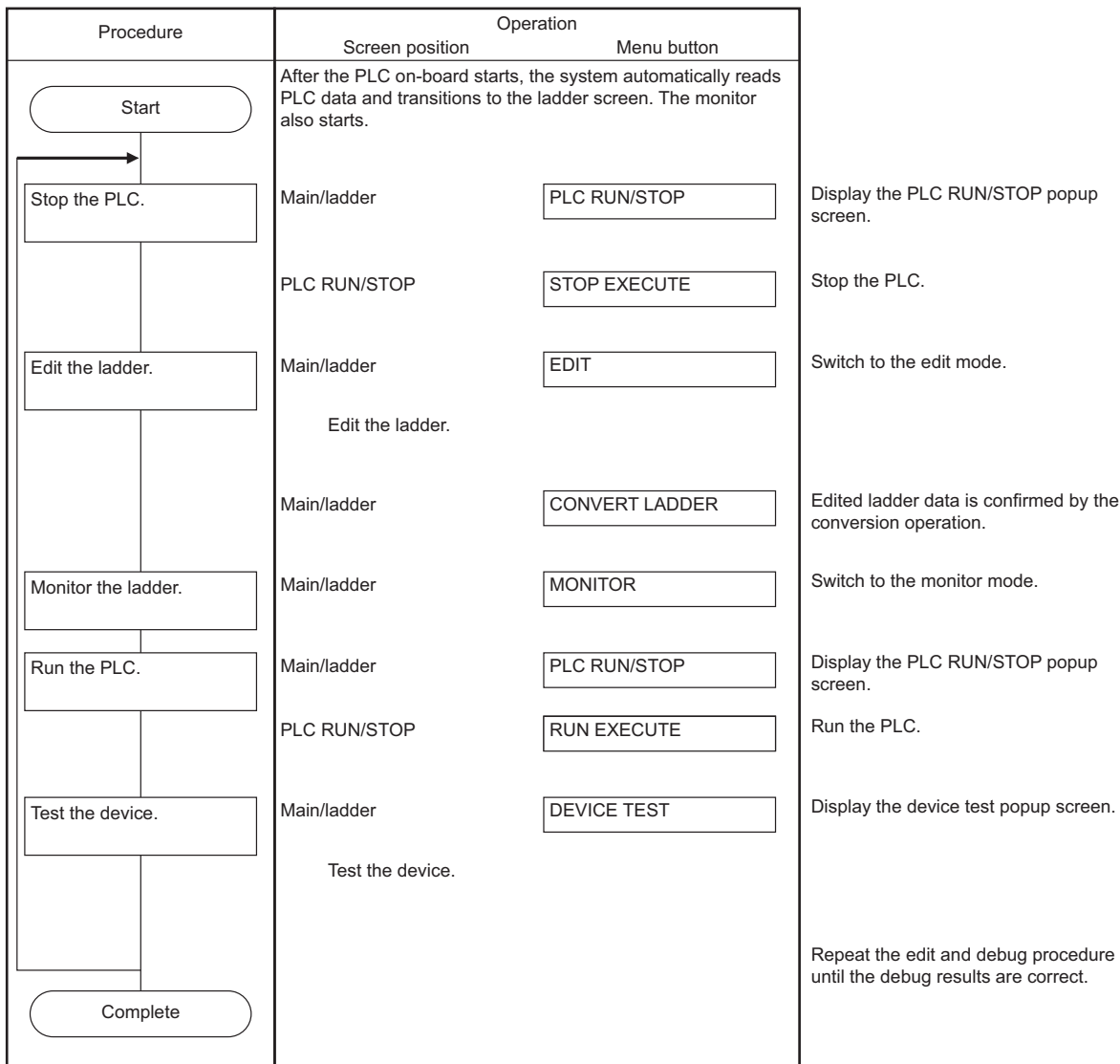

To use multiple projects

Procedure	Operation		
	Screen position	Menu button	
Start			
Select the current project.	Main	SELECT PROJECT	Select the current operation project.
Transition to the ladder screen.	Main	LADDER	PLC data is automatically read and the system transitions to the ladder screen. The monitor also automatically starts.
Stop the PLC.	Main/ladder	PLC RUN/STOP	Display the PLC RUN/STOP popup screen.
	PLC RUN/STOP	STOP EXECUTE	Stop the PLC.
Edit the ladder.	Main/ladder	EDIT	Switch to the edit mode.
	Edit the ladder.		
	Main/ladder	CONVERT LADDER	Edited ladder data is confirmed by the conversion operation.
Monitor the ladder.	Main/ladder	MONITOR	Switch to the monitor mode.
Run the PLC.	Main/ladder	PLC RUN/STOP	Display the PLC RUN/STOP popup screen.
	PLC RUN/STOP	RUN EXECUTE	Run the PLC.
Test the device.	Main/ladder	DEVICE TEST	Display the device test popup screen.
	Test the device.		Repeat the edit and debug procedure until the debug results are correct.
Return to the main screen.	Main/ladder		Return to the main screen.
Complete			Select the project at the main screen to select a different project storing the sequence program to be edited.

6.11.3.2 Save the Sequence Program to the Internal ROM

The following diagram illustrates the procedure to save sequence programs, which have been edited and debugged, to the internal ROM. The same procedure is executed whether using only one project or using multiple projects.

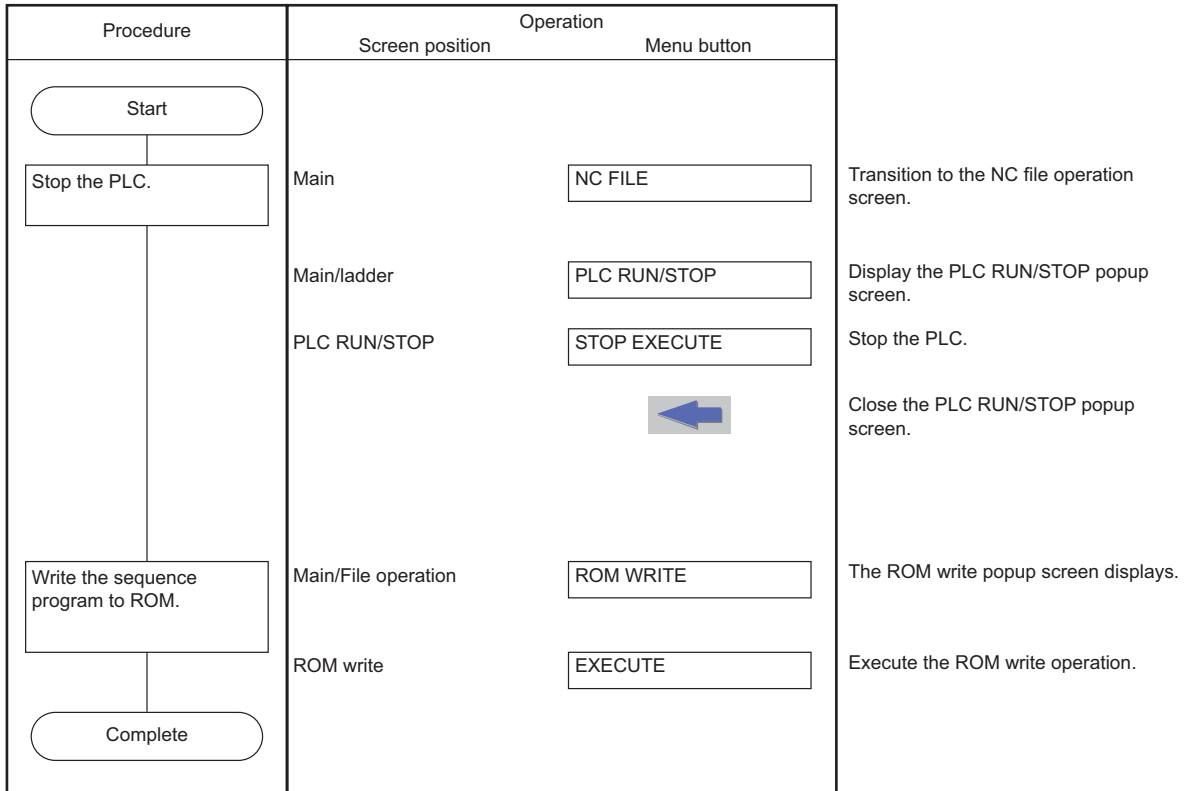

6.11.4 Basic Operation 4 (Creating Multiple Sequence Programs)

Follow the sequence of operations as described in the following table to create multiple programs.

Procedure	Operation
(1)	Add a sequence program
(2)	Configure the execution order of sequence programs
(3)	Edit and debug the sequence program
(4)	Save the sequence program to the internal ROM

Only a project without labels can be created.

A new program can be added and edited only when operation mode is GX Developer. For setting method of operation mode, refer to "Operation mode settings".

When operation mode is GX Works2, add or edit a sequence program to a project with GX Works2, and then store the program in the CNC from an external device. Refer to "6.11.5 Basic Operation 5 (Loading Programs Created with GX Developer/GX Works2)" for operation method of external device.



6.11.4.1 Adding Sequence Programs

The following diagrams illustrate the procedure to add sequence programs.

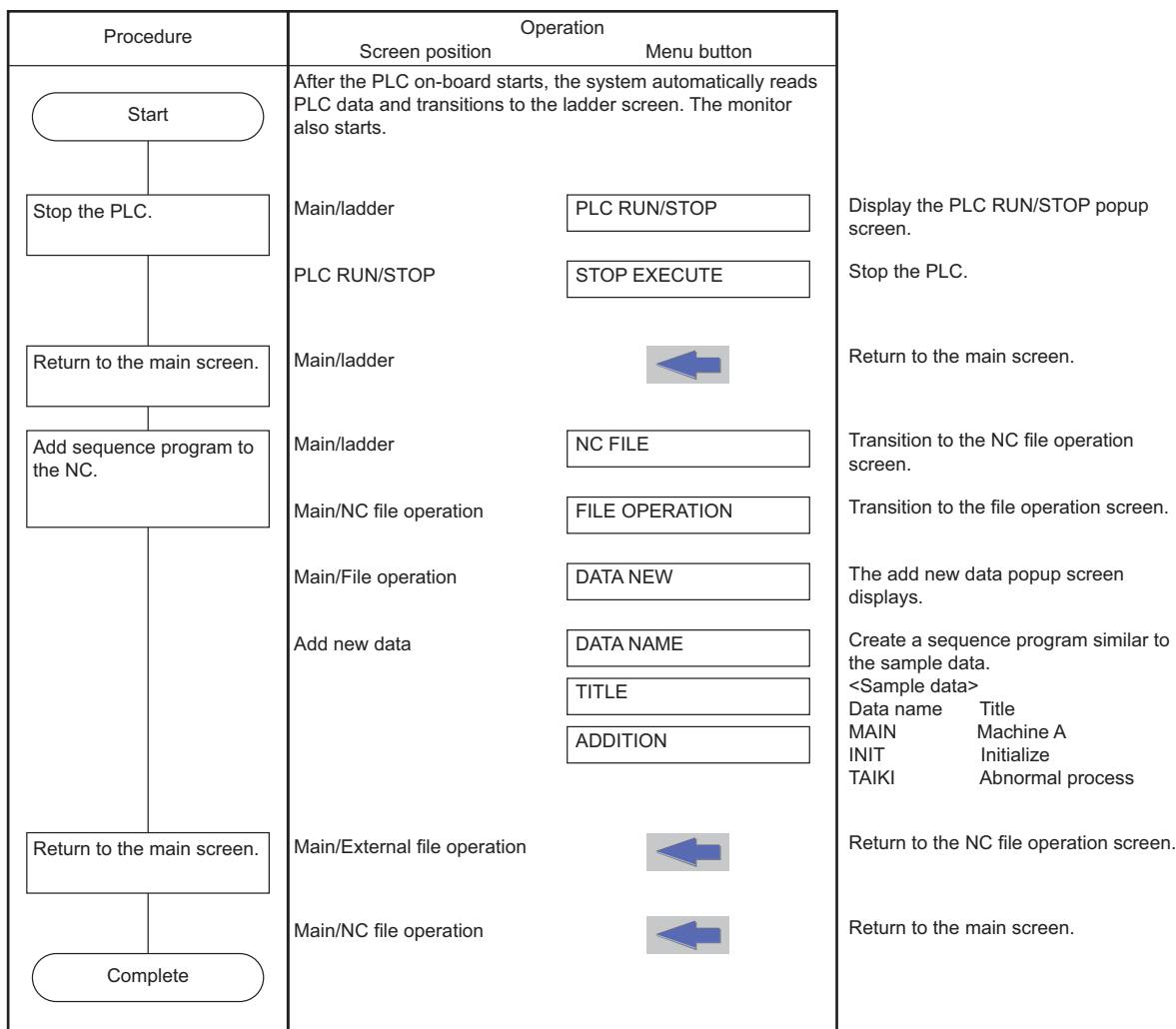
To use only one project



To use multiple projects

Procedure	Operation		
	Screen position	Menu button	
Start			
Select the current project.	Main	SELECT PROJECT	Select the current operation project.
Stop the PLC.	Main	NC FILE	Transition to the NC file operation screen.
	Main/NC file operation	PLC RUN/STOP	Display the PLC RUN/STOP popup screen.
	PLC RUN/STOP	STOP EXECUTE	Stop the PLC.
			Return to the NC file operation screen.
Add sequence program to the NC.	Main/NC file operation	FILE OPERATION	Transition to the file operation screen.
	Main/file operation	DATA NEW	The add new data popup screen displays.
	Add new data	DATA NAME	Create a sequence program similar to the sample data. <Sample data> Data name Title MAIN Machine A INIT Initialize TAIKI Abnormal process
	TITLE		
	ADDITION		
Return to the main screen.	Main/file operation		Return to the NC file operation screen.
	Main/NC file operation		Return to the main screen.
Complete			Repeat this procedure until the sequence program has been added to all projects.

6.11.4.2 Configuring the Execution Order of Sequence Programs

The following diagrams illustrate the procedure to configure the execution order of sequence programs.

To use only one project

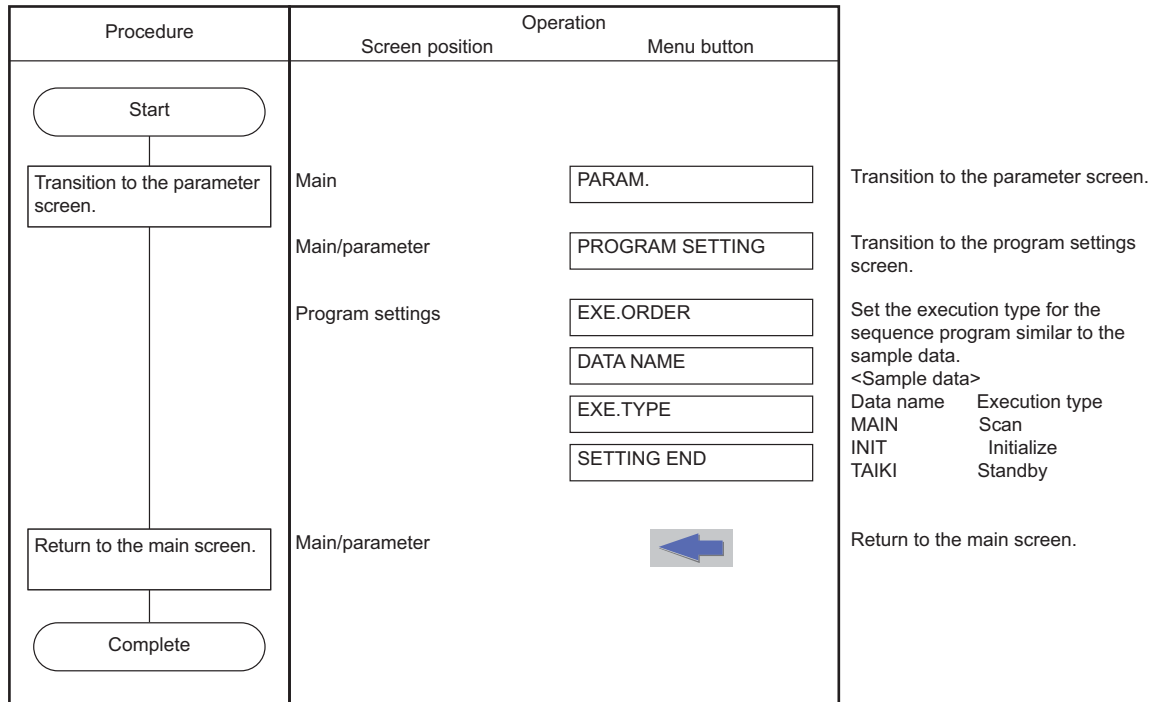

To use multiple projects

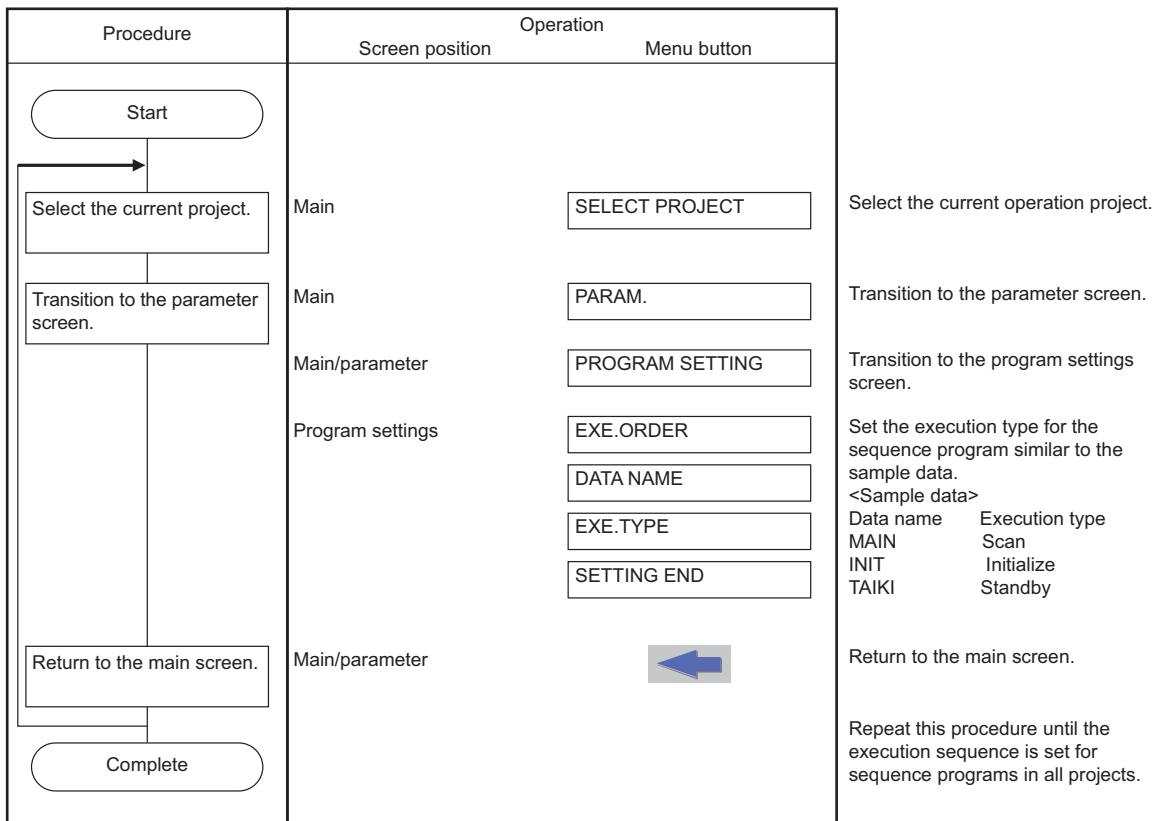

6.11.4.3 Editing and Debugging the Sequence Program

The following diagrams illustrate the procedure to edit and debug sequence programs stored in the NC.

To use only one project

Procedure	Operation		
	Screen position	Menu button	
Start	After the PLC on-board starts, the system automatically reads PLC data and transitions to the ladder screen. The monitor also starts.		
Stop the PLC.	Main/ladder	PLC RUN/STOP	Display the PLC RUN/STOP popup screen.
	PLC RUN/STOP	STOP EXECUTE	Stop the PLC.
Edit the ladder.	Main/ladder	EDIT	Switch to the edit mode.
	Edit the ladder.		
	Main/ladder	CONVERT LADDER	Edited ladder data is confirmed by the conversion operation.
Monitor the ladder.	Main/ladder	MONITOR	Switch to the monitor mode.
Run the PLC.	Main/ladder	PLC RUN/STOP	Display the PLC RUN/STOP popup screen.
	PLC RUN/STOP	RUN EXECUTE	Run the PLC.
Test the device.	Main/ladder	DEVICE TEST	Display the device test popup screen.
	Test the device.		Repeat the edit and debug procedure until the debug results are correct.
Switch programs.	Main/ladder	PROGRAM CHANGE	Display the switch program screen.
	Switch to a program that has not yet been edited.		Continue switching programs until all sequence programs have been edited and debugged.
Complete			

To use multiple projects

Procedure	Operation		
	Screen position	Menu button	
Start			
Select the current project.	Main	SELECT PROJECT	Select the current operation project.
Transition to the ladder screen.	Main	LADDER	PLC data is automatically read and the system transitions to the ladder screen. The monitor also automatically starts.
Stop the PLC.	Main/ladder	PLC RUN/STOP	Display the PLC RUN/STOP popup screen.
	PLC RUN/STOP	STOP EXECUTE	Stop the PLC.
Edit the ladder.	Main/ladder	EDIT	Switch to the edit mode.
	Edit the ladder.		
	Main/ladder	CONVERT LADDER	Edited ladder data is confirmed by conversion operation.
Monitor the ladder.	Main/ladder	MONITOR	Switch to the monitor mode.
Run the PLC.	Main/ladder	PLC RUN/STOP	Display the PLC RUN/STOP popup screen.
	PLC RUN/STOP	RUN EXECUTE	Run the PLC.
Test the device.	Main/ladder	DEVICE TEST	Display the device test popup screen.
	Test the device.		Repeat the edit and debug procedure until the debug results are correct.
Switch programs.	Main/ladder	PROGRAM CHANGE	Display the switch program screen.
	Switch to a program that has not yet been edited.		Continue switching programs until all sequence programs have been edited and debugged.
Return to the main screen.	Main/ladder		Return to the main screen.
Complete			Select the project at the main screen to select a different project storing the sequence program to be edited.

6.11.4.4 Save the Sequence Program to the Internal ROM

The following diagram illustrates the procedure to save sequence programs, which have been edited and debugged, to the internal ROM. The same procedure is executed whether using only one project or using multiple projects.

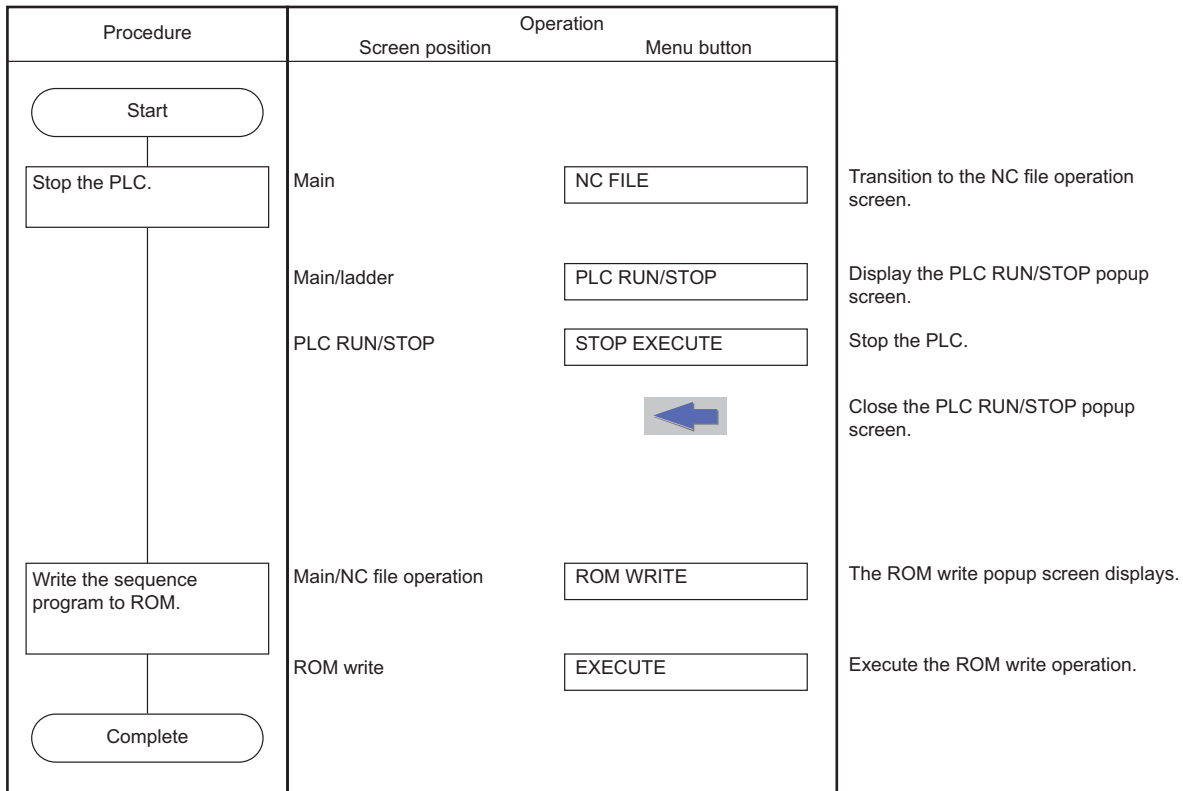

6.11.5 Basic Operation 5 (Loading Programs Created with GX Developer/GX Works2)

Follow the sequence of operations as described in the following table to load and adjust ladders created with GX Developer/ GX Works2.

Procedure	Operation
(1)	Saving PLC data to an External Device
(2)	Save PLC data in external devices to the NC

To load a project of GX Developer, change the operation mode to GX Developer.

To load a project of GX Works2, change the operation mode to GX Works2.

For setting method of operation mode, refer to " Operation mode settings".

6.11.5.1 Saving PLC Data to an External Device

The following diagram illustrates the procedure to save PLC data to an external device. The same procedure is executed whether using only one project or using multiple projects.

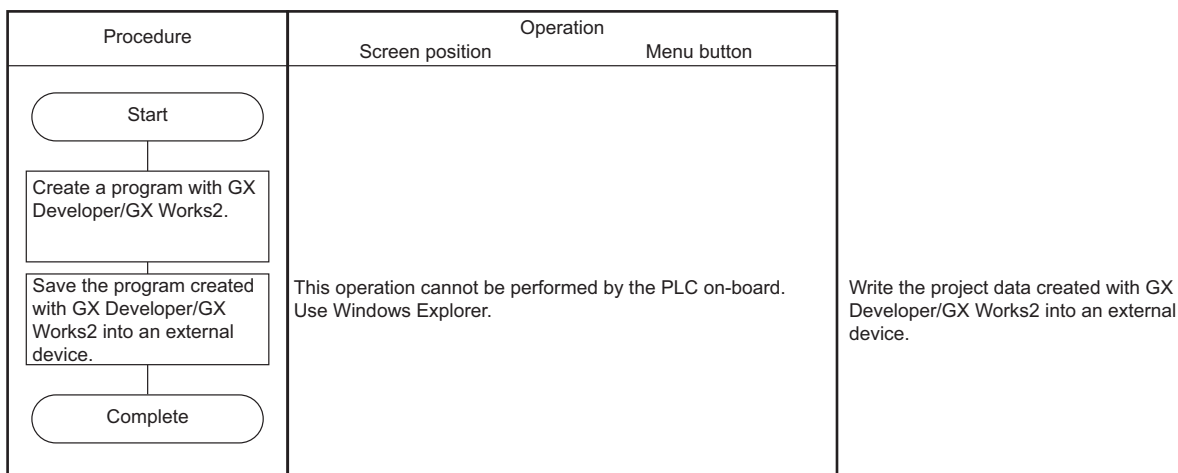

When saving a project to external device with GX Works2, save it with one file format. Work space format is not supported by PLC on-board.

6.11.5.2 Saving PLC Data in External Devices to the NC

The following diagram illustrates the procedure to save PLC data in external devices to the NC.

To use only one project

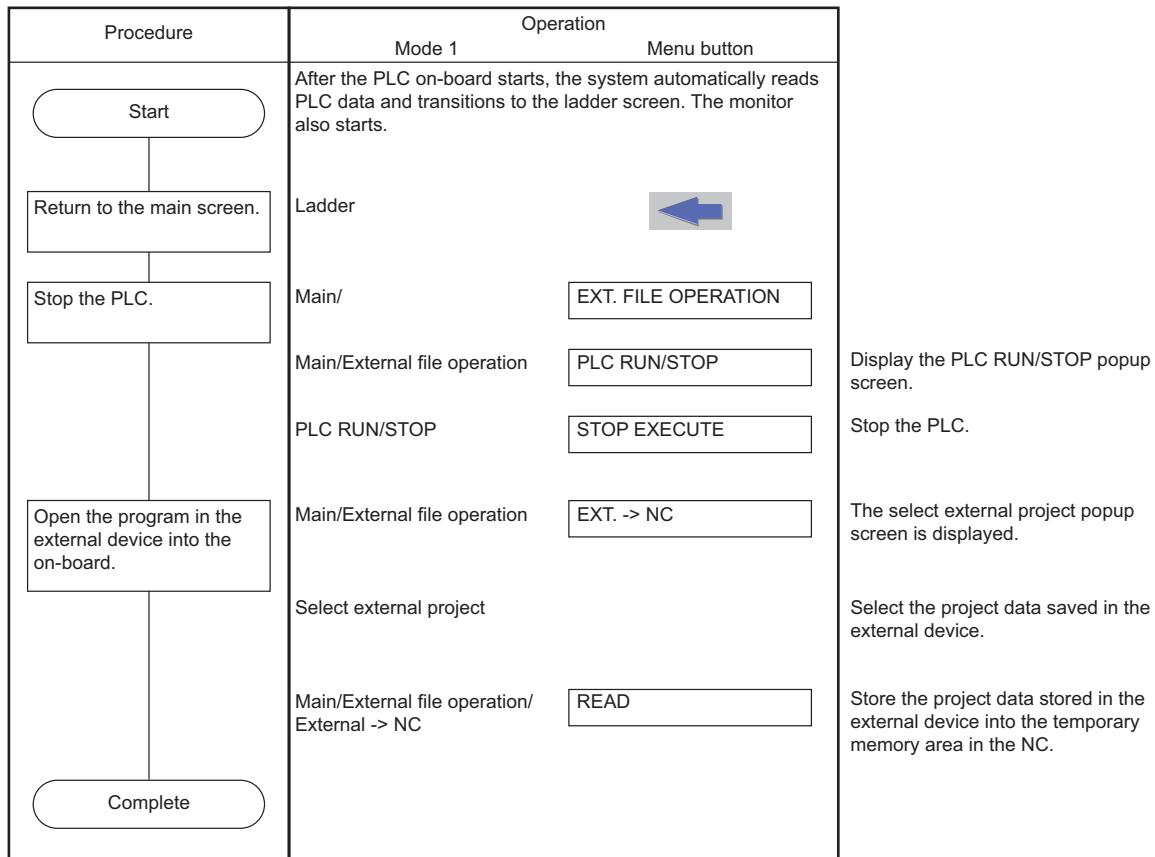

To use multiple projects

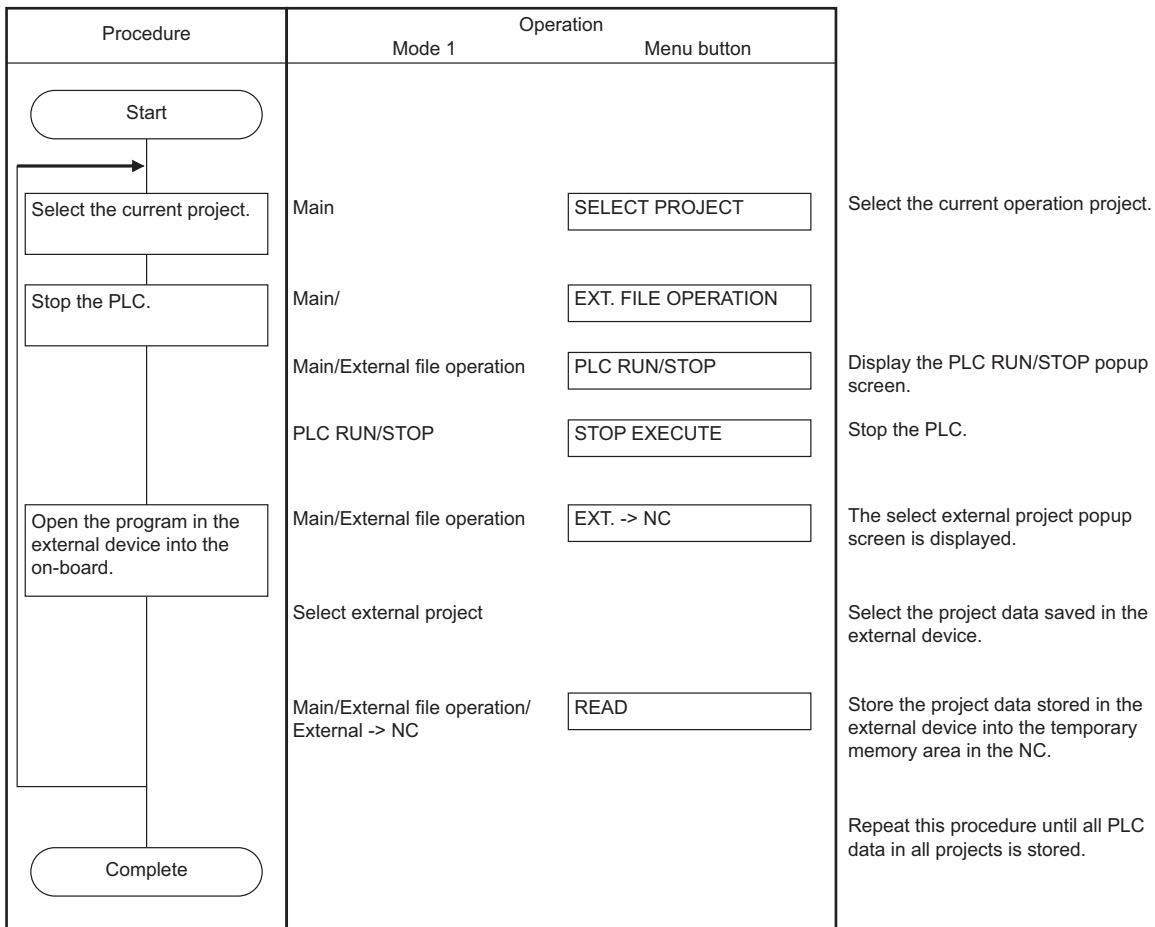

6.11.6 Basic Operation 6 (Updating the Program Version)

Follow the sequence of operations as described in the following table to update the version of PLC data in the NC with PLC data in an external device.

Procedure	Operation
(1)	Saving the Updated Version Data to an External Device
(2)	Update the PLC data version in NC

A program can be updated only when operation mode is GX Developer. For setting method of operation mode, refer to "Operation mode settings".

6.11.6.1 Saving the Updated Version Data to an External Device

The following diagram illustrates the procedure to save the updated version data to an external device. The updated version data must be stored in "ladXX" (XX is a project No.), a directory directly under the external device. For the project format, the project name needs to be set as "plcproj". Refer to "6.13.13.5 Storing Method of the Updating Version Data" for details.

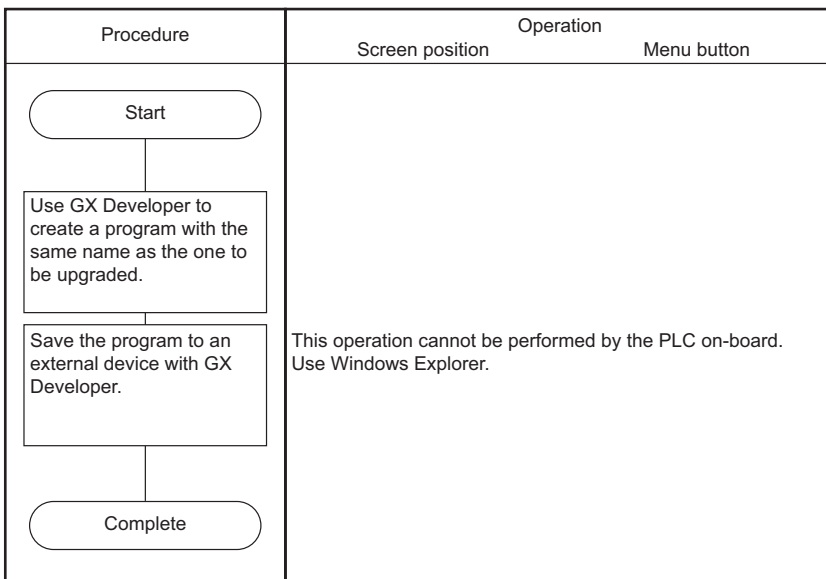

Write the project data created with GX Developer to an external device.

6.11.6.2 Updating the PLC Data Version in NC

Given below is the procedure to use the version updating data stored in an external device to upgrade the PLC data in the NC.

The PLC data which can be upgraded are as follows: sequence program, PLC message, device comment and parameter. For details of operation on the PLC version upgrade screen, refer to "6.13.12.6 Update the PLC Version".

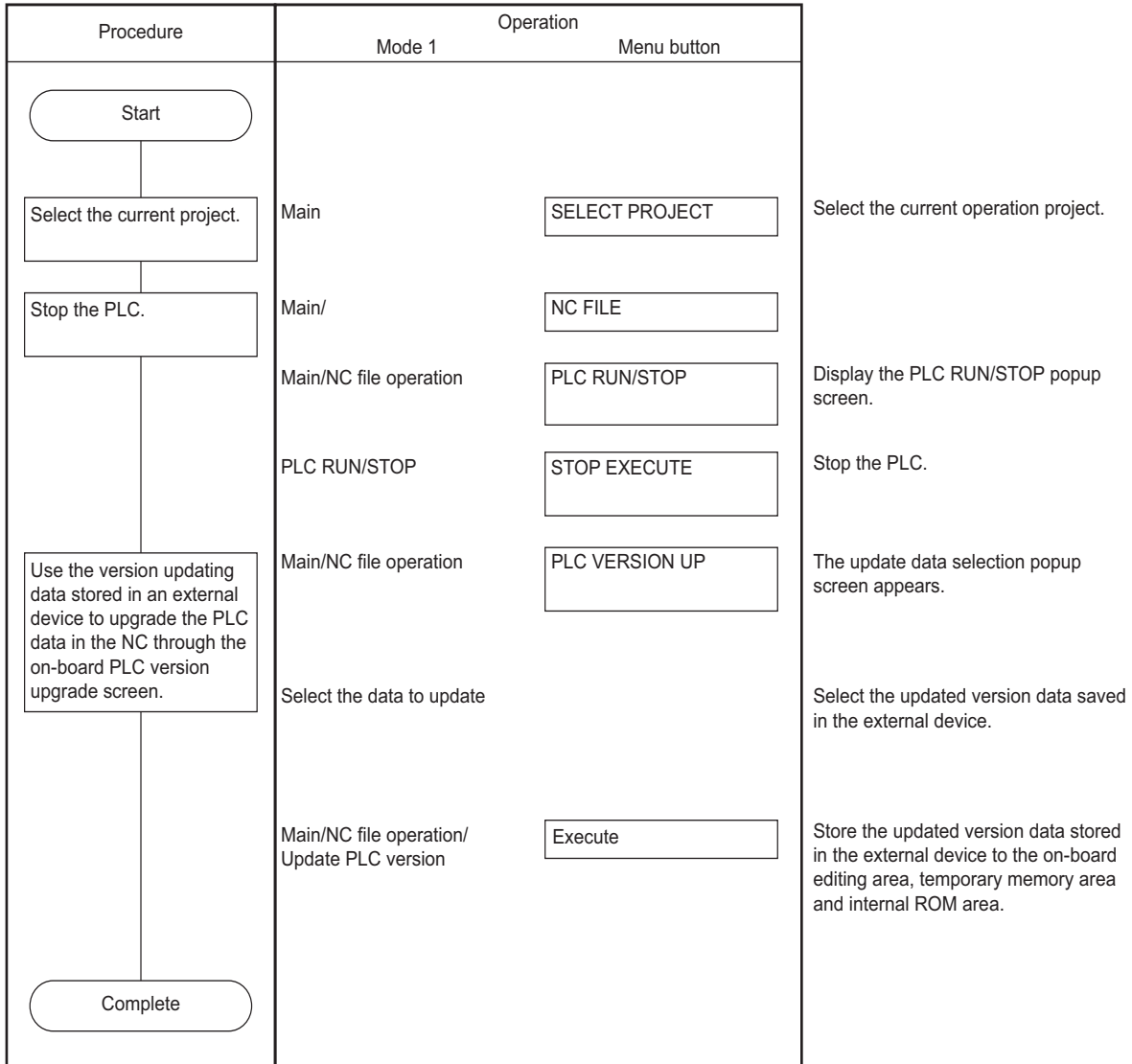

6.12 Main Screen

The multiple projects you may want to use can be selected at the main (highest tier) PLC On-board screen. This screen also displays the status of the currently connected NC.

When the smart safety observation function is enabled, the user safety sequence "SafePLC1" or "SafePLC2" can be selected as the operation target. Hereafter, the project or user safety sequence targeted for the operation is referred to as the operation target project.

6.12.1 Switching Menu Keys

The menu keys on the main screen change depending on whether sequence programs are stored or not stored in the NC.

Sequence programs	Menu keys
Stored	Menu keys for all usable functions are displayed.
Not stored	Menu keys related to storing and creating sequence programs and menu keys for configuring the NC environment are displayed.

6.12.1.1 Cases in which Sequence Programs are Stored

To use multiple projects

When using multiple projects, information for up to the maximum number of projects stored in the NC is displayed. The desired project can also be selected.

[When the smart safety observation function is disabled]

M01	PROJECT1								
MAIN									
Please select the operation target project.									
	LABEL	PROGRAM	READ	EXE.ORDER	PROJ. RATIO				
PROJECT1		EXIST	READY	1	50				
PROJECT2		NONE	NONE	2	10				
PROJECT3		NONE	NONE	3	10				
PROJECT4		NONE	NONE	4	10				
PROJECT5		NONE	NONE	5	10				
PROJECT6		NONE	NONE	6	10				
BND-2000W200-									
NC FILE	EXT.FILE OPERATION	LADDER	DEVICE	PARAM.	PLC DIAGNOSIS	ENVIRON. SETTING			SELECT PROJECT

[When the smart safety observation function is enabled]

M01	PROJECT1								
MAIN									
Please select the operation target project.									
	LABEL	PROGRAM	READ	EXE.ORDER	PROJ. RATIO				
PROJECT1		EXIST	READY	1	50				
PROJECT2		NONE	NONE	2	10				
PROJECT3		NONE	NONE	3	10				
PROJECT4		NONE	NONE	4	10				
PROJECT5		NONE	NONE	5	10				
PROJECT6		NONE	NONE	6	10				
SafePLC1		EXIST	NONE	-	-				
SafePLC2		EXIST	NONE	-	-				
BND-2000W200-									
NC FILE	EXT.FILE OPERATION	LADDER	DEVICE	PARAM.	PLC DIAGNOSIS	ENVIRON. SETTING			SELECT PROJECT

To use only one project

When using only one project, there is no need to select the desired project. For this reason, after the PLC On-board starts and the main screen displays, the system automatically reads PLC data, transitions to the ladder screen and starts the monitor.

[When the smart safety observation function is disabled]

M01	PROJECT1								
MAIN									
Please select the operation target project.									
	LABEL	PROGRAM	READ	EXE.ORDER	PROJ. RATIO				
PROJECT1		EXIST	READY	1	100				
BND-2000W200-									
NC FILE	EXT.FILE OPERATION	LADDER	DEVICE	PARAM.	PLC DIAGNOSIS	ENVIRON. SETTING			SELECT PROJECT

[When the smart safety observation function is enabled]

M01	PROJECT1								
MAIN									
Please select the operation target project.									
	LABEL	PROGRAM	READ	EXE.ORDER	PROJ. RATIO				
PROJECT1		EXIST	NONE	1	100				
SafePLC1		EXIST	NONE	-	-				
SafePLC2		EXIST	NONE	-	-				
BND-2000W200-									
NC FILE	EXT.FILE OPERATION	LADDER	DEVICE	PARAM.	PLC DIAGNOSIS	ENVIRON. SETTING			SELECT PROJECT

A progress bar is displayed indicating the status of reading PLC data. (Refer to "6.14.10 Progress Screen" for display at GX Works2)

[GX Developer project]

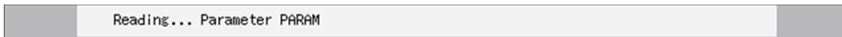

The menu keys change as follows.



The message to confirm the suspension appears when the suspend menu is pressed.

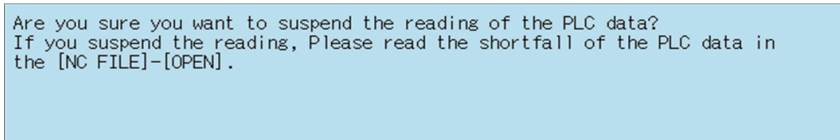

If you suspend the reading, specify and read the PLC data which has not been read with the [NC FILE] - [OPEN] function. Refer to "6.13.3 Opened Screen".

Note

- (1) When a message below appears while reading PC data, the number of device points that is set in the PC parameter and the number of device points that is set in the multi-project parameter are not matched.
 There is a possibility that the device number/type which are used by the ladder circuit may change when reading PC data is continued. Therefore, do not use the ladder circuit being read.
 After having formatted the storage area once, you need to review the number of device points in PC parameter and multi-project parameter, and rewrite the ladder again.

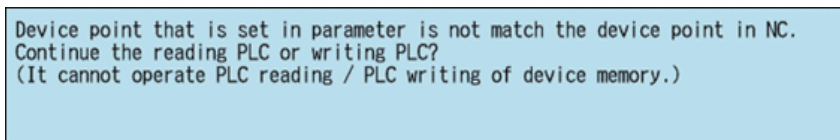

For a project with labels or a structured project, when device points do not match, a message "Device points set in the parameters and device points in NC do not match. The reading from PLC or writing to PLC is suspended." is displayed and is not read.

The reading from PLC or writing to PLC is suspended." is displayed and is not read.

- (2) Install MELSEC software when operation mode is GX Works2. The following message is displayed when reading PLC data of a project stored in CNC if MELSEC software is not installed. Restart CNC again and execute the same procedure. If the error message is displayed again, contact Mitsubishi Electric representative in your region.

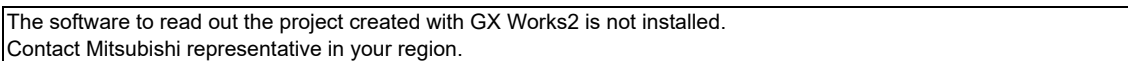

- (3) The following message is displayed if symbolic information is not written in CNC when a project with labels or a structured project is stored. In this case, PLC on-board operates as a project without labels is stored.

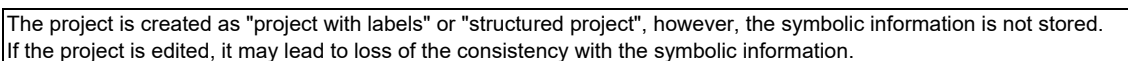

6 Explanation of Built-in Editing Function (PLC On-board)

6.12 Main Screen

- (4) The error message is displayed if the following operations are executed and PLC data is read with PLC on-board when a project with labels or a structured project is stored.
- After writing a project without labels or a structured project with GX Works2 to CNC, start another GX Works2 with setting of a project without labels and switch the program files.
 - When writing a project with labels or a structured project with GX Works2 to CNC, PC parameter is not written.
- When this message is displayed, confirm the combination of stored symbolic information and program file or store the PC parameters of the stored project to CNC, then read again.

Symbolic information and program file do not match, or symbolic information and PLC parameters were not read out at the same time.
The project can not be read out: the project is in an uncompiled status.

- (5) The following message is displayed when a project stored in CNC is not supported by operation mode (refer to "Operation mode and readable project").

The project cannot be read out: the project with labels created with GX Works2 was attempted to be read out while "operation mode" on the PLC on-board is set to GX Developer.

Execute one of the following when this message is displayed.

- Change a project stored in CNC to be supported by PLC on-board operation mode using GX Developer or GX Works2.
 - Change PLC on-board operation mode. (Refer to "Operation mode settings")
 - Execute CNC format with PLC on-board. (Refer to "6.13.8 Format Popup Screen")
- (6) An error may occur when CNC language parameters do not match those of a project stored in CNC. (Refer to "6.5.3 Precautions for Language Setting for GX Works2 Project") When the following message is displayed, set the CNC language parameters to a project language, and read again.

Failed to read out: language settings do not match.
Go to the GX Works2 Setting screen, and set the project language to be the same as that used to create the ladder.

- (7) Even when a structured project is stored in the target project, if all the program blocks that can be displayed on ladder screen are locked with block passwords, the following message is displayed without transiting to the ladder screen. When this message is displayed, clear the block password on POU LIST screen. (Refer to "6.13.14.9 Block Password Disable")

All the program blocks that can be displayed in the ladder screen are locked with the block password.
Please unlock the block password.

- (8) Even when a project with labels or a structured project is stored in the target project, if no program is created in a language that can be displayed on ladder screen, the following message is displayed without transiting to the ladder screen. When this message is displayed, create a program created in a language that can be displayed on ladder screen in a project.
Refer to "6.1.4 Language" for the program language that can be displayed on ladder screen.

There is no program created with the programming language that is supported by the ladder screen.

- (9) When the PLC on-board detects an unsupported parameter, the circuit screen is not displayed after automatic reading and the following message is displayed.

Failed to read out the data because the data have been made with a product newer than this version.
This will read out the default parameter.

In this case, the error may be avoided by following the steps below.

- Restore the parameters to the default values in GX Works2, and reset only the necessary parameters.
- Store the parameters in the CNC again.

[User safety sequence 2]

The following message is displayed when parameters are written in user safety sequence 2. Select "Yes" and continue reading.

The device points set in the parameter do not match the device points in NC.
Continue the reading PLC or writing PLC?
(It cannot operate PLC reading / PLC writing of device memory.)

6.12.1.2 Cases in which Sequence Programs are not Stored

To use multiple projects

When using multiple projects, information for up to the maximum number of projects stored in the NC is displayed. The desired project can also be selected.

[When the smart safety observation function is disabled]

M01	PROJECT1								
MAIN									
Please select the operation target project.									
	LABEL	PROGRAM	READ	EXE.ORDER	PROJ. RATIO				
	PROJECT1	NONE	NONE	1	50				
	PROJECT2	NONE	NONE	2	10				
	PROJECT3	NONE	NONE	3	10				
	PROJECT4	NONE	NONE	4	10				
	PROJECT5	NONE	NONE	5	10				
	PROJECT6	NONE	NONE	6	10				
BND-2000W200-									
FILE OPE.	EXT.->NC	ROM WRITE	PROJECT SETTING	DEVICE SETTING		PLC DIAGNOSIS	CONNECT NC CHANGING		SELECT PROJECT

[When the smart safety observation function is enabled]

M01	PROJECT1								
MAIN									
Please select the operation target project.									
	LABEL	PROGRAM	READ	EXE.ORDER	PROJ. RATIO				
	PROJECT1	NONE	NONE	1	50				
	PROJECT2	NONE	NONE	2	10				
	PROJECT3	NONE	NONE	3	10				
	PROJECT4	NONE	NONE	4	10				
	PROJECT5	NONE	NONE	5	10				
	PROJECT6	NONE	NONE	6	10				
	SafePLC1	NONE	NONE	-	-				
	SafePLC2	NONE	NONE	-	-				
BND-2000W200-									
FILE OPE.	EXT.->NC	ROM WRITE	PROJECT SETTING	DEVICE SETTING		PLC DIAGNOSIS	CONNECT NC CHANGING		SELECT PROJECT

To use only one project

When using only one project, there is no need to select the desired project. As no sequence programs are stored, you cannot transition to the ladder screen. PLC data is also not automatically read.

[When the smart safety observation function is disabled]

M01	PROJECT1								
MAIN									
Please select the operation target project.									
	LABEL	PROGRAM	READ	EXE.ORDER	PROJ. RATIO				
PROJECT1		NONE	NONE	1	100				
BND-2000W200-									
FILE OPE.	EXT.->NC	ROM WRITE	PROJECT SETTING	DEVICE SETTING		PLC DIAGNOSIS	CONNECT NC CHANGING		SELECT PROJECT

[When the smart safety observation function is enabled]

M01	PROJECT1								
MAIN									
Please select the operation target project.									
	LABEL	PROGRAM	READ	EXE.ORDER	PROJ. RATIO				
PROJECT1		NONE	NONE	1	100				
SafePLC1		NONE	NONE	-	-				
SafePLC2		NONE	NONE	-	-				
BND-2000W200-									
FILE OPE.	EXT.->NC	ROM WRITE	PROJECT SETTING	DEVICE SETTING		PLC DIAGNOSIS	CONNECT NC CHANGING		SELECT PROJECT

6.12.2 Screen Display Items

The following table describes the screen display items on the main screen.

Item name	Display state
Connected NC name	This displays the name of the connected NC.
Current project No.	This displays the number of the current project.
Current project label	This displays the project label.
Alarm message	Alarm messages are displayed when alarms occur.
Software keyboard	This is displayed only when parameters are enabled.

The information in the following table is displayed in the main screen.

Item	Description
Project No.	Displays project numbers up to the maximum number of projects
Labels	This displays labels assigned to projects. However, for the user safety sequence, this section is always blank.
Programs	This displays whether or not programs are stored in the projects.
Read	This displays whether or not PLC data has been read.
Execution sequence	This displays the execution sequence set for each project. This is left blank if the execution sequence has not been set.
Project ratio	This displays the project ratio set for each project.

6.12.3 Enabled/Disabled State of Menu Keys

The following information describes the conditions upon which menu keys displayed on the main screen are enabled.

6.12.3.1 Cases in which Sequence Programs are Stored

The following table describes the conditions upon which menu keys are enabled/disabled when sequence programs are stored.

The menu keys which are not described in the following table are always enabled.

Menu name	Condition upon which it is enabled/disabled
NC File Operation	Disabled when the function is restricted.
External File Operation	Disabled when the function is restricted.
LADDER	Disabled when the function is restricted. Disabled when the project is not read.
Device	Disabled when the function is restricted.
PARAM.	Disabled when the function is restricted.
ENVIRON. SETTING	Disabled when the function is restricted.
SELECT PROJECT	Always enabled when using multiple projects and smart safety observation function is enabled. Disabled when using only one project.

6.12.3.2 Cases in which Sequence Programs are not Stored

The following table describes the conditions upon which menu keys are enabled/disabled when sequence programs are not stored.

The menu keys which are not described in the following table are always enabled.

Menu name	Condition upon which it is enabled/disabled
FILE OPE.	Disabled when the function is restricted. Hidden when operation mode of the project is GX Works2.
EXE.->NC	Disabled when the function is restricted.
ROM WRITE	Disabled when the function is restricted.
PROJECT SETTING	Disabled when the function is restricted.
DEVICE SETTING	Disabled when the function is restricted.
SELECT PROJECT	Always enabled when using multiple projects and smart safety observation function is enabled. Disabled when using only one project.
GX Works2 Setting	Enabled in GX Works2 mode. Disabled when the function is restricted.

6.12.4 SELECT PROJECT

When using multiple projects, the current project needs to be selected. The area with the blue background color in the list displayed in the main screen represents the current project. Multiple projects cannot be selected as the current project for operation.

When using only one project, project 01 automatically becomes the current project and thus there is no need to select the current project.

If the current project selected is changed, the menu keys change in correspondence with how sequence programs are stored. When the smart safety observation function is enabled, as the user safety sequence "SafePLC1" or "SafePLC2" is displayed, select "SafePLC1" or "SafePLC2" to use the user safety sequence.

Use one of the following two methods to change the currently selected project.

■ Method using the project selection menu key

Pressing the project selection menu key moves down the selected position in the list of project information. Pressing the menu key when the project at the bottom of the list is selected selects the project at the top of the list.

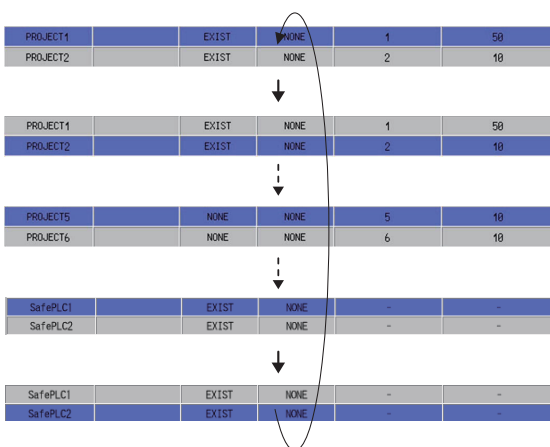

■ Method using the up and down arrow keys

Pressing the down arrow key moves down the selected position in the list of project information.

Pressing the up arrow key moves up the selected position in the list of project information.

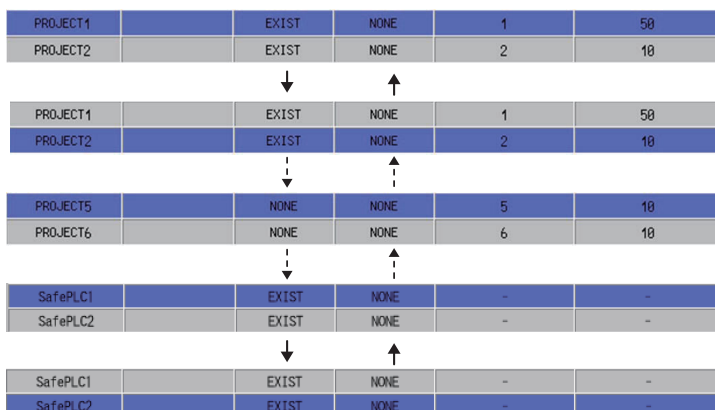

6.12.5 Operation of Key Presses

The following table describes the operation of each menu key and the keys on the NC keyboard when pressed.

6.12.5.1 Cases in which Sequence Programs are Stored

Item name	Operation
NC FILE	This transitions to the NC file operation main screen.
EXT.FILE OPERATION	This transitions to the external file operation main screen.
LADDER	This transitions to the ladder screen. (Refer to "Operation when ladder menu is selected.")
DEVICE	This transitions to the device main screen.
PARAM.	This transitions to the parameter main screen.
PLC DIAGNOSIS	This transitions to the PLC diagnosis screen.
ENVIRON. SETTING	This transitions to the environment settings main screen.

Operation when ladder menu is selected.

■ Normal operation

- (1) This automatically reads the PLC data stored in the target project.
- (2) This transitions to the ladder screen. This displays the program without block password.
- (3) This automatically starts ladder monitor.

■ Abnormal operation

This following table describes the details of error messages displayed when "Ladder" menu is selected, and remedy. Refer to "6.1.4 Language" for the program language that can be displayed on ladder screen.

Error message	Error details	Remedy
All the program blocks created in a language that can be displayed on ladder screen are locked with block passwords. Clear the block password.	This message is displayed when all the program blocks created in a language that can be displayed on ladder screen are locked with block passwords and are in locked state.	Clear the block password on POU LIST screen.
There is no program created with the programming language that is supported by the ladder screen.	This message is displayed when no program is created in a language that can be displayed on ladder screen.	Create a program in a language that can be displayed on ladder screen.

6.12.5.2 Cases in which Sequence Programs are not Stored

Item name	Operation
FILE OPE.	This transitions to the file operation screen.
EXE.->NC	This transitions to the "EXT.->NC" screen.
ROM WRITE	This transitions to the ROM write screen.
PROJECT SETTING	This transitions to the project settings screen.
DEVICE SETTING	This transitions to the device settings screen.
PLC DIAGNOSIS	This transitions to the PLC diagnosis screen.
CONNECT NC CHANGING	This transitions to the connect NC changing screen.

6.12.6 Returning to the Main Screen from Other Screens

When transitioning to the main screen and there are no sequence programs stored in the current project, the menu keys corresponding to the state when there are no sequence programs stored are displayed.

6.13 NC File Operation Menus

6.13.1 NC File Operation Main Screen

6.13.1.1 Outline

This screen contains menus of operations for PLC data stored in the NC.

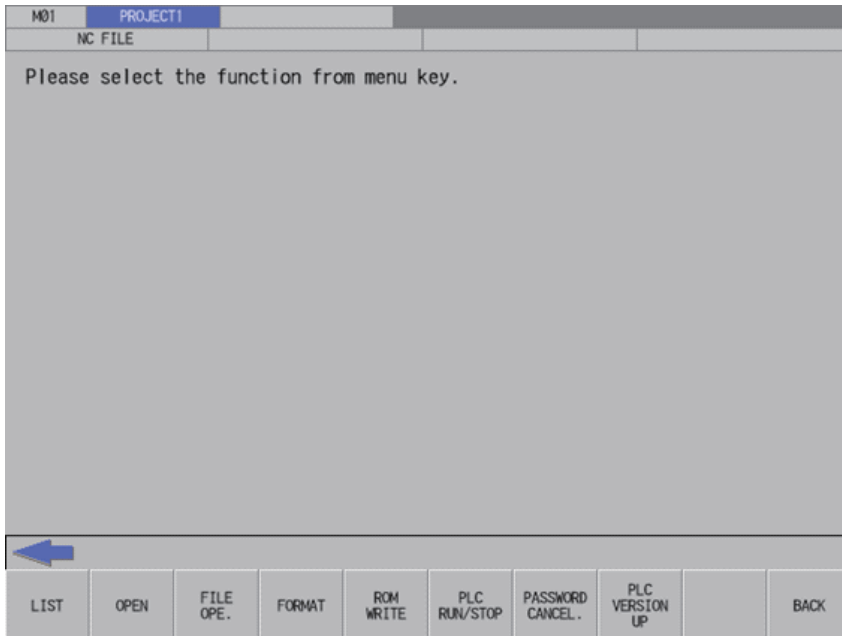

6.13.1.2 Screen Display Items

The following table describes the screen display items for the NC file operation screen.

Item name	Display state
Connected NC name	This displays the name of the connected NC.
Current project No.	This displays the current project number.
Current project label	This displays the project label.
Alarm message	Alarm messages are displayed when alarms occur.
Left arrow key	This is displayed when enabled.
Software keyboard	This is displayed only when parameters are enabled.

6.13.1.3 Enabled/Disabled State of Menu Keys

The following information describes the conditions upon which menu keys displayed on the NC file operation screen are enabled/disabled.

The menu keys which are not described in the following table are always enabled.

Menu name	Condition upon which it is enabled/disabled
ROM WRITE	Disabled when the function is restricted.
FILE OPE.	Disabled at the following: <ul style="list-style-type: none"> • When function is limited • When operation mode is GX Works2
FORMAT	Disabled when the function is restricted.
PLC RUN/STOP	Disabled when the function is restricted.
PASSWORD CANCEL.	Disabled when the function is restricted.
PLC VERSION UP	Disabled at the following: <ul style="list-style-type: none"> • When function is limited • When operation mode is GX Works2

6.13.1.4 Operation of Key Presses

The following table describes the operation of each menu key and the keys on the NC keyboard when pressed.

Item name	Operation
Left arrow key/return menu key	These transition to the main menu.
Various menu keys	This displays the specified screen.

6 Explanation of Built-in Editing Function (PLC On-board)

6.13 NC File Operation Menus

6.13.2 File List Screen

6.13.2.1 Outline

This displays the file size, execution step, and POU list for the PLC data stored in the operation target project. The amount of free space for each project in the NC is also displayed.

"POU LIST" is enabled only when a project with labels or a structured project in GX Works2 format is stored.

[File size display screen]

NC FILE		FILE LIST							
<FILE NAME>	<TITLE>	<DATE OF UPDATE>		<FILE SIZE>					
PROGRAM									
MAIN	TEST_PROGRAM	2021/02/17	18:37:48	2176	Byte				
MAIN1		2021/02/17	18:37:50	2160	Byte				
MAIN2		2021/02/17	18:37:50	2160	Byte				
MAIN3		2021/02/17	18:37:50	2160	Byte				
MAIN4		2021/02/17	18:37:52	2160	Byte				
MAIN5		2021/02/17	18:37:52	2160	Byte				
MAIN6		2021/02/17	18:37:54	2160	Byte				
MAIN7		2021/02/17	18:37:54	2160	Byte				
MAIN8		2021/02/17	18:37:56	2160	Byte				
MAIN9		2021/02/17	18:37:56	2160	Byte				
Message									
MO1TEST	TEST_MESSAGE	2021/02/17	18:37:58	2160	Byte				
DEVICE COMMENT	COMMENT	2021/02/17	18:37:58	492	Byte				
Parameter	PLC/Network	2021/02/17	18:39:16	616	Byte				

FILE SIZE DISPLAY	EXECUTE STEP	FREE SPACE VOLUME							CLOSE
-------------------	--------------	-------------------	--	--	--	--	--	--	-------

[Execution step display screen]

NC FILE		FILE LIST							
<FILE NAME>	<TITLE>	<EXE. TYPE:STEP NUM>							
PROGRAM									
MAIN	TEST_PROGRAM	M :	6 step						
MAIN1		W :	2 step						
MAIN2		W :	2 step						
MAIN3		W :	2 step						
MAIN4		W :	2 step						
MAIN5		W :	2 step						
MAIN6		W :	2 step						
MAIN7		W :	2 step						
MAIN8		W :	2 step						
MAIN9		W :	2 step						
		-TOTAL-	= 24 / 1032128 step						

FILE SIZE DISPLAY	EXECUTE STEP	FREE SPACE VOLUME							CLOSE
-------------------	--------------	-------------------	--	--	--	--	--	--	-------

[Amount of free space display screen]

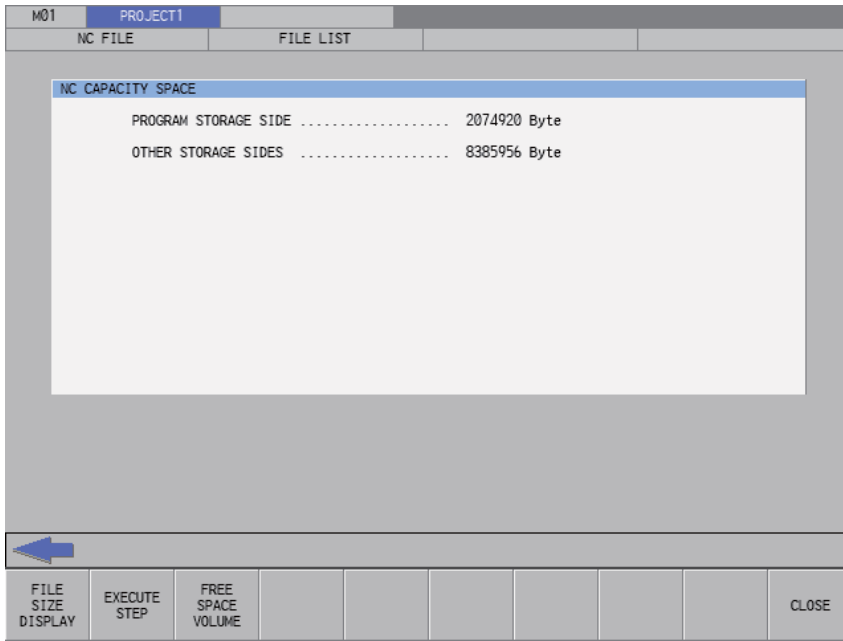

6.13.2.2 Screen Display Items

The following table describes the screen display items for the file list screen.

Item name	Display state
Connected NC name	This displays the name of the connected NC.
Current project No.	This displays the current project number.
Current project label	This displays the project label.
Alarm message	Alarm messages are displayed when alarms occur.
Left arrow key	This is displayed when enabled.
Software keyboard	This is displayed only when parameters are enabled.
List	[File Size Display] This displays the file size of the PLC data stored in the current project. This displays nothing if there is nothing stored. [Execution Step Display] This displays the execution step of the sequence program stored in the current project. This displays nothing if there is nothing stored. [Amount of Free Space Display] This displays the amount of free space allocated to the current project.

6.13.2.3 Enabled/Disabled State of Menu Keys

The following information describes the conditions upon which menu keys displayed on the NC file operation screen are enabled/disabled. The menu keys which are not described in the following table are always enabled.

Menu name	Condition upon which it is enabled/disabled
POU List	Hidden when operation mode of the project is GX Developer. Disabled when a program is not read due to a file password or an error. Enabled when a project with labels or a structured project is stored when operation mode of a project is GX Works2.

6.13.2.4 Status during Screen Displays

The following table describes the status when displaying the file list screen.

Item name	Operation
List	This is the default focus position when the screen is displayed. This displays the file size of the PLC data stored in the current project.

6.13.2.5 Operation of Key Presses

The following table describes the operation of each menu key and the keys on the NC keyboard when pressed.

Item name	Operation
Left arrow key	Refer to "6.13.2.6 Closing the File List Screen".
File size display	This displays the size of files stored in the connected project.
Execution step	This displays the execution step of programs stored in the current project.
Amount of free space display	This displays the amount of free space available in the region used to store programs and the region used to store other data.
POU List	This displays the POU list screen. Refer to "6.13.14 POU LIST screen".
Close	Refer to "6.13.2.6 Closing the File List Screen".

6.13.2.6 Closing the File List Screen

Use any of the following methods to close the file list screen.

Methods to close the screen
Press the [CLOSE] menu key.
Press the left arrow key.
Press the [ESC] key on the software keyboard.

6.13.3 Opened Screen

6.13.3.1 Outline

This displays a list of PLC data stored in the current project and reads the selected data.

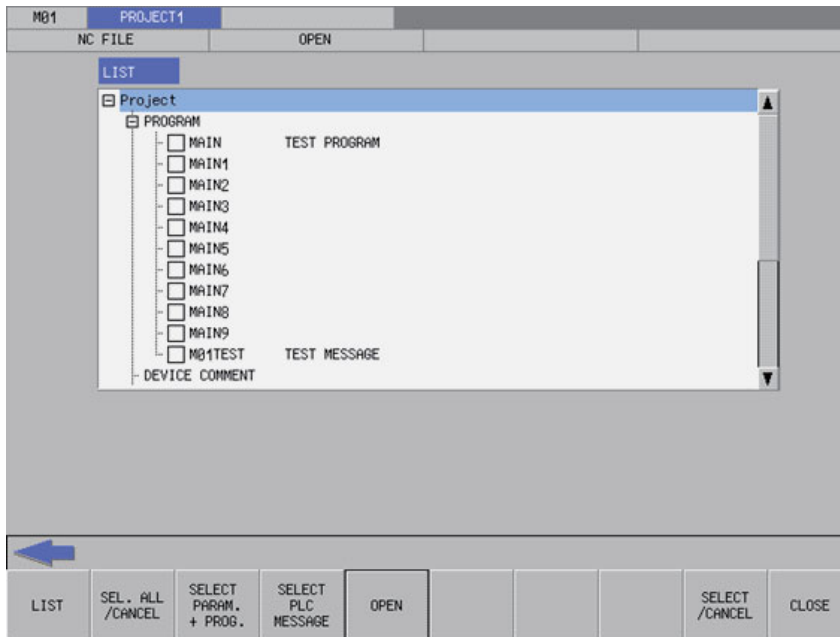

6.13.3.2 Screen Display Items

The following table describes the screen display items for the opened screens.

Item name	Display state
Connected NC name	This displays the name of the connected NC.
Current project No.	This displays the current project number.
Current project label	This displays the project label.
Alarm message	Alarm messages are displayed when alarms occur.
Left arrow key	This is displayed when enabled.
Software keyboard	This is displayed only when parameters are enabled.
List	This displays the PLC data stored in the current project. This displays nothing of there is nothing stored.

6.13.3.3 Enabled/Disabled State of Menu Keys

The following information describes the conditions upon which menu keys displayed on the opened screen are enabled/disabled.

The menu keys which are not described in the following table are always enabled.

Menu name	Condition upon which it is enabled/disabled
Select/cancel all data	Enabled when operation mode of a project is GX Developer and selectable PLC data has been added to the list
Parameter + Program	Enabled when operation mode of a project is GX Developer and selectable PLC data has been added to the list
PLC messages	Enabled when selectable PLC data has been added to the list
Open	Enabled when selectable PLC data has been added to the list
Select/cancel data	Enabled when operation mode of a project is GX Developer and selectable PLC data has been added to the list

6.13.3.4 Status during Screen Displays

The following table describes the status when the opened screen is displayed.

Item name	Operation
List	<p>This is the default focus position when the screen is displayed.</p> <p>This displays the PLC data stored in the current project.</p> <p>Check status changes depending on the operation mode as follows:</p> <ul style="list-style-type: none"> • GX Developer mode Not checked • GX Works2 mode Device comment is not checked. Other than device comment is checked.

6.13.3.5 Operation of Key Presses

The following table describes the operation of each menu key and the keys on the NC keyboard when pressed.

Item name	Operation
Left arrow key	Refer to "6.13.3.7 Closing the Opened Screen".
List	The focus is applied to the list.
Select/cancel all data	This checks/unchecks the check boxes for all data in the list.
Parameter + Program	This checks the check boxes for parameters and programs in the list. This does not include PLC messages however.
PLC messages	This checks the check boxes for the PLC messages in the list.
Open	Refer to "6.13.3.6 Opening PLC Data".
Select/cancel data	This selects/deselects the check boxes for the selected data in the list. This operation can also be performed with the [SP (space)] key.
Close	Refer to "6.13.3.7 Closing the Opened Screen".

6.13.3.6 Opening PLC Data

Normal operation

- (1) Press the [LIST] menu key to move the focus to the list. Select the desired PLC data from the list. Uncheck the check boxes for data you do not want read.
 Check status of PLC data of other than device comment is fixed as enabled when operation mode is GX Works2.
- (2) After selecting data, press the [OPEN] menu key. After pressing the key, the PLC data selected from the list is read.
 When operation mode is GX Works2, cancel the PLC data of current open project, then read the PLC data in the list.

If a password to protect reads/writes has been registered to the selected files, the cancel password screen is displayed.
 Enter the password to temporarily cancel the password.
 If the password is canceled, processing will continue.
 When operation mode is GX Works2, since all the program data is read, cancel the password of all registered programs to read all the program data.
 Refer to "Canceling File Passwords" for information on entering and canceling passwords.

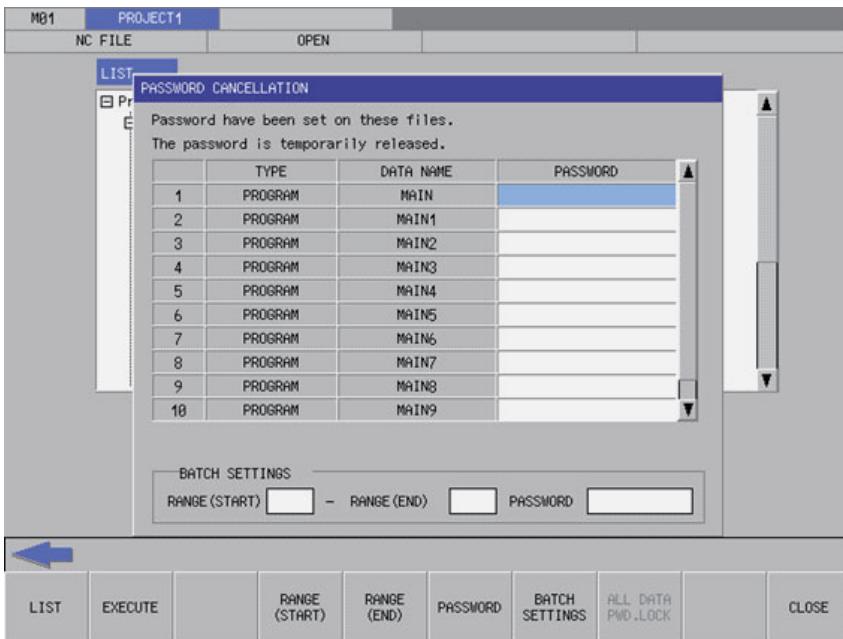

If PLC data with the same name has already been read, the confirm overwrite popup screen is displayed.
 When operation mode is GX Works2, since PLC data cannot be selected and all the PLC data is changed, the confirm overwrite popup screen is not displayed.

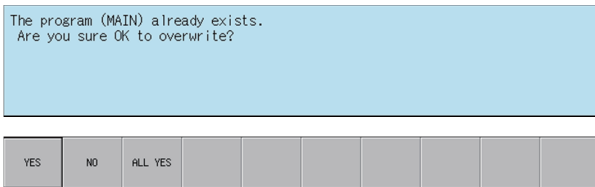

A progress bar is displayed indicating the status of reading PLC data. (Refer to "6.14.10 Progress Screen" for display at GX Works2)

[GX Developer project]



(3) After the selected PLC data has been read, the complete message is displayed.

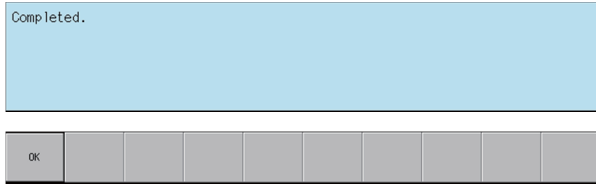

Note

(1) When a project with labels or a structured project is stored in CNC, the project is read in symbolic information units. When symbolic information is read, all the programs in symbolic information are read. The project cannot be read in program file units.

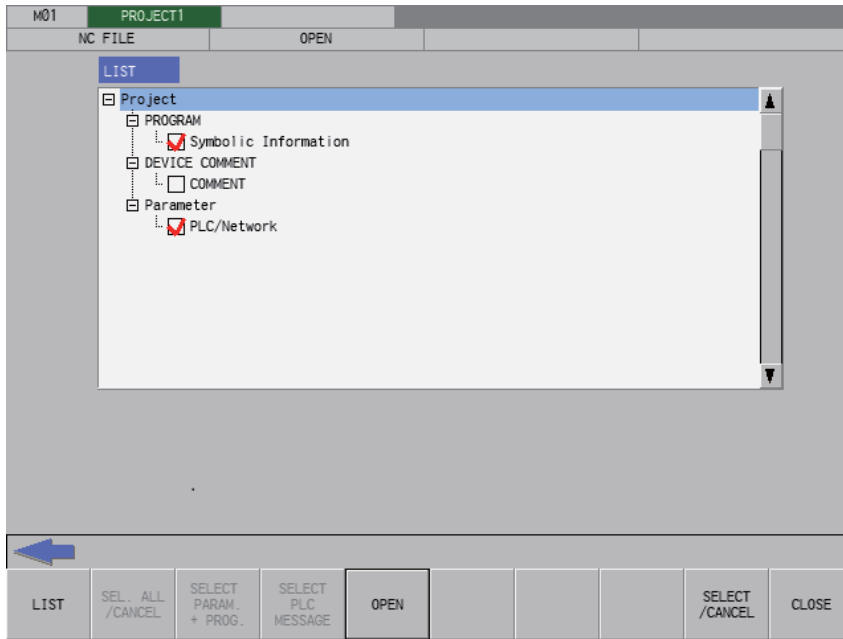

Temporarily disable the password of all program files with password registered if program files in symbolic information have password that cannot be read/written. Temporarily disable the password to read a program file. Refer to "6.21 Canceling File Passwords" for information disable file passwords.

Abnormal operation

This information describes the details of error messages displayed on the opened screen and the corrective action thereof.

Error message	Error details	Remedy
Read data has not been selected.	This is displayed when the [OPEN] menu key is pressed before any PLC data has been selected from the displayed list.	Select PLC data from the displayed list before pressing the [OPEN] menu key.
The project is created as "project with labels" or "structured project", however, the symbolic information is not stored. If the project is edited, it may lead to loss of the consistency with the symbolic information.	This message is displayed when opening a project with labels or a structured project while symbolic information is not stored in CNC.	This does not effect operation of PLC on-board. (Operates as a project without labels.) Note that when editing with PLC on-board, symbolic information created of a project with labels or a structured project may differ.
Symbolic information and program file do not match, or symbolic information and PLC parameters were not read out at the same time. The project can not be read out: the project is in an uncompiled status.	This message is displayed in the following cases. • Symbolic information of a project with labels stored in CNC differ from the program file. • When executing "Open" with [Symbolic Information] checked and [Parameter] - [PC/Network] unchecked.	Check and store only program files that match symbolic information. Store the PC parameters of projects with symbolic information in CNC, then execute "Open" with [Symbolic Information] and [Parameter] - [PC/Network] checked in the list.
The project cannot be read out: the project with labels created with GX Works2 was attempted to be read out while "operation mode" on the PLC on-board is set to GX Developer.	This message is displayed when executing "Open" to a project with labels created with GX Works2 when operation mode of PLC on-board is GX Developer.	Change the operation mode of a project to GX Works2, then restart PLC on-board. For setting method of operation mode refer to "6.1.3 Operation Mode of Project".
The project cannot be read out: the structured project created with GX Works2 was attempted to be read out while "operation mode" on the PLC on-board is set to GX Developer.	This message is displayed when executing "Open" to a structured project created with GX Works2 when operation mode of PLC on-board is GX Developer.	Change the operation mode of a project to GX Works2, then restart PLC on-board. For setting method of operation mode refer to "6.1.3 Operation Mode of Project".
The project cannot be read out: the project with labels created with GX Developer was attempted to be read out while "operation mode" on the PLC on-board is set to GX Works2.	This message is displayed when executing "Open" to a project with labels created with GX Developer when operation mode of PLC on-board is GX Works2.	Change the operation mode of a project to GX Developer, then restart PLC on-board. For setting method of operation mode refer to "6.1.3 Operation Mode of Project".
Reading out a project with labels created with GX Developer. This project is not supported, it will be read out as a project without labels.	This message is displayed when reading a project with labels created with GX Developer.	This does not effect operation of PLC on-board. (Operates as a project without labels.) Note that when editing with PLC on-board, symbolic information of a project with labels may differ.
Failed to read out the data because the data have been made with a product newer than this version. This will read out the default parameter.	This message is displayed when the PLC on-board detects an unsupported parameter.	The error may be avoided by following the steps below. (1) Restore the parameters to the default values in GX Works2, and reset only the necessary parameters. (2) Store the parameters in the CNC again.

6.13.3.7 Closing the Opened Screen

Use any of the following methods to close the opened screen.

Methods to close the screen
Press the [CLOSE] menu key.
Press the left arrow key.
Press the [ESC] key on the software keyboard.

6.13.4 File Operation Screen

6.13.4.1 Outline

This displays a list of PLC data stored in the current project as well as creates and deletes new PLC data and changes the name of this data.

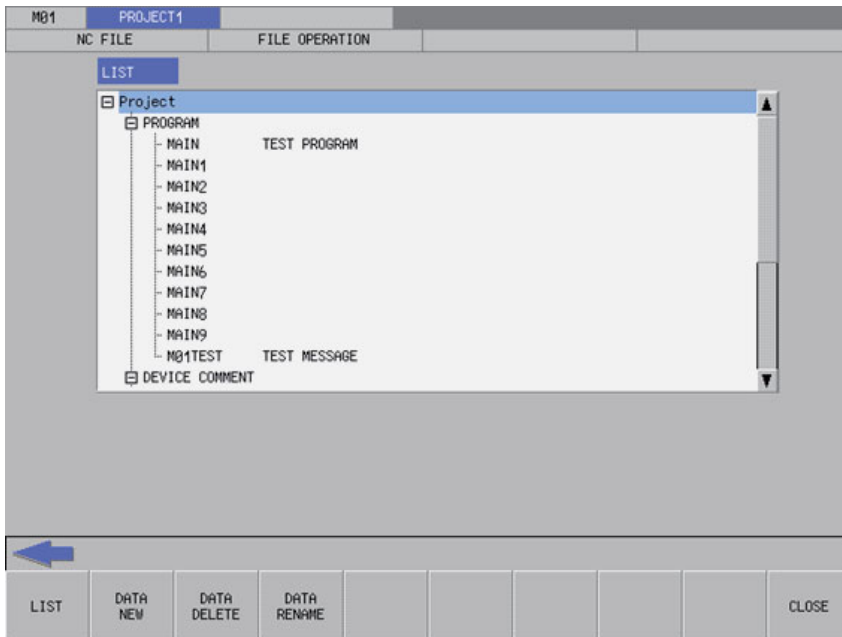

6.13.4.2 Screen Display Items

The following table describes the screen display items for the file operation screen.

Item name	Display state
Connected NC name	This displays the name of the connected NC.
Current project No.	This displays the current project number.
Current project label	This displays the project label.
Alarm message	Alarm messages are displayed when alarms occur.
Left arrow key	This is displayed when enabled.
Software keyboard	This is displayed only when parameters are enabled.
List	This displays the PLC data stored in the current project. This displays nothing if there is nothing stored.

6.13.4.3 Enabled/Disabled State of Menu Keys

The following information describes the conditions upon which menu keys displayed on the file operation screen are enabled/disabled.

The menu keys which are not described in the following table are always enabled.

Menu name	Condition upon which it is enabled/disabled
Delete Data	Enabled when PLC data is displayed in the list.
Data Rename	Enabled when PLC data is displayed in the list.

6.13.4.4 Status during Screen Displays

The following table describes the status when displaying the file operation screen.

Item name	Operation
List	This is the default focus position when the screen is displayed. This displays the PLC data stored in the current project.

6.13.4.5 Operation of Key Presses

The following table describes the operation of each menu key and the keys on the NC keyboard when pressed.

Item name	Operation
Left arrow key	Refer to "6.13.4.6 Closing the File Operation Screen". Returns to the screen from where the file operation screen was displayed.
List	The focus is applied to the list.
Add New Data	The add new data popup screen is displayed. (Refer to "6.13.5 Add New Data Popup Screen")
Delete Data	This displays the delete data popup screen. (Refer to "6.13.6 Delete Data Popup Screen")
Rename Data	This displays the rename data popup screen. (Refer to "6.13.7 Rename Data Popup Screen")
Close	Refer to "6.13.4.6 Closing the File Operation Screen".

6.13.4.6 Closing the File Operation Screen

Use any of the following methods to close the file operation screen.

Methods to close the screen
Press the [CLOSE] menu key.
Press the left arrow key.
Press the [ESC] key on the software keyboard.

6.13.5 Add New Data Popup Screen

6.13.5.1 Outline

This enables new PLC data to be created for the current project.

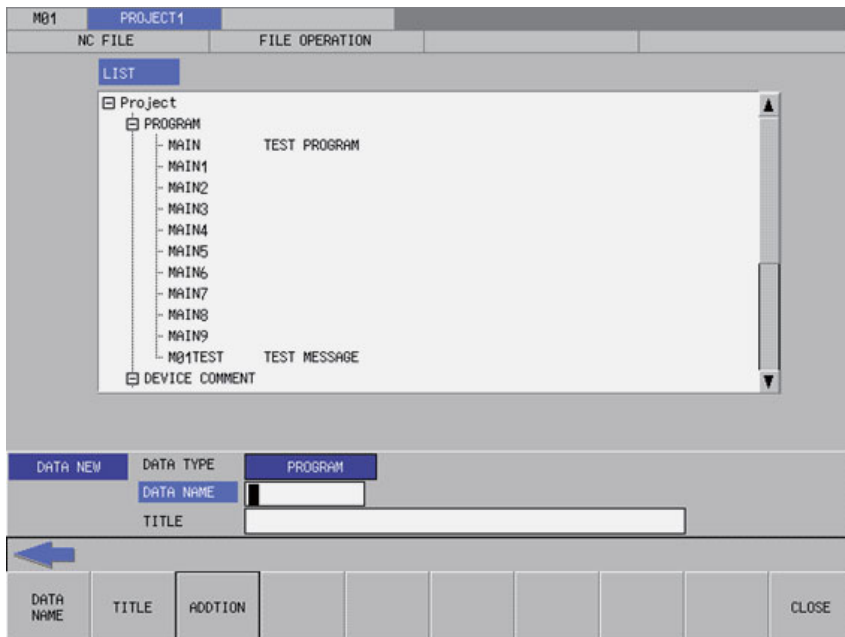

6.13.5.2 Screen Display Items

The following table describes the screen display items for the add new data popup screen.

Item name	Display state
Data type	This displays only programs.
Data name	This is left blank. These are restricted to a maximum of 8 single-byte alphanumeric numeric characters.(*1)
Title	This is left blank. These are restricted to a maximum of 8 single-byte alphanumeric numeric characters.(*1)

(*1) Refer to "6.6.1 PLC Data Used by the PLC On-board" for information on restrictions to PLC data names and titles.

6.13.5.3 Enabled/Disabled State of Menu Keys

The menu keys displayed on the add new data popup screen are always enabled.

6.13.5.4 Status during Screen Displays

The following table describes the status when displaying the add new data popup screen.

Item name	Operation
Data name	This is the default focus position when the screen is displayed.

6.13.5.5 Operation of Key Presses

The following table describes the operation of each menu key and the keys on the NC keyboard when pressed.

Item name	Operation
Left arrow key	Refer to "6.13.5.7 Closing the Add New Data Popup Screen".
Data name	This selects the data name input field.
Title	This selects the title input field.
Add	Refer to "6.13.5.6 Adding PLC Data".
Close	Refer to "6.13.5.7 Closing the Add New Data Popup Screen".

6.13.5.6 Adding PLC Data

Normal operation

- Press the [DATA NAME] menu key and enter the desired PLC data name into the data name input field.
- Press the [TITLE] menu key and enter a title that identifies the PLC data you are adding into the title input field. (Entering titles is optional.)
- Press the [ADD] menu key. Pressing this key closes the add new data popup screen and adds the PLC data with the entered name and title. The name of the added PLC data displays in the list on the file operation screen.

The added PLC data is operated as a project without labels.

If PLC data with the same name already exists, the confirm overwrite popup screen is displayed.

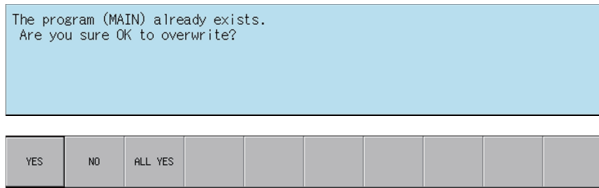

If PLC data is added while the PLC is running, a message confirming whether or not to pause the PLC is displayed. Select [YES] to stop the PLC and continue adding the PLC data. If [NO] is selected, the PLC does not stop which results in an error and the display of an error message. (Refer to "Abnormal operation")

If the PLC stops, a message displays to confirm whether or not to restart the PLC immediately after data has been added. Select [YES] to continue running the PLC. Select [NO] to keep the PLC stopped.

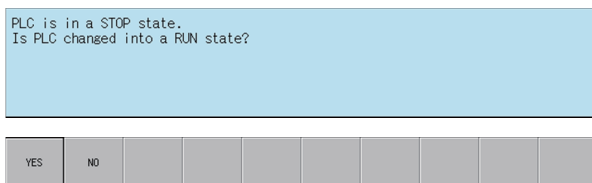
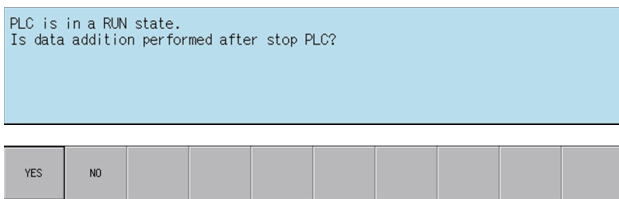

Abnormal operation

This information describes the details of error messages displayed on the add new data popup screen and the corrective action thereof.

Error message	Error details	Remedy
A data name has not been entered. Enter a data name.	This is displayed when the [ADD] menu key is pressed while the data name input field is still blank.	Enter a valid data name before pressing the [ADD] menu key.
This project/data name is a reserved device name. Please choose another name.	This is displayed after the [ADD] menu key is pressed when a reserved device name (*1) has been entered as the data name.	Enter a valid data name before pressing the [ADD] menu key.
Prohibited characters were used in the file name. Do not use the following characters in file names: /, :, ,, ;, *, ?, \, ", <, >,	This is displayed when the [ADD] menu key is pressed and the data name contains prohibited characters (*1).	Enter a valid data name before pressing the [ADD] menu key.
File name includes the multi-byte character code. Please confirm file name.	This is displayed when the [ADD] menu key is pressed and the data name contains double-byte characters.	Enter a valid data name before pressing the [ADD] menu key.
Illegal characters have been used for a data name. Use legal characters.	This is displayed when the [ADD] menu key is pressed and the final character of the data name is a period.	Enter a valid data name before pressing the [ADD] menu key.
New data cannot be added because the PLC is running. Execute again after the PLC stops.	This is displayed when trying to add new data without stopping the PLC.	Add new data when the PLC is not running.

(*1) Refer to "6.6.1 PLC Data Used by the PLC On-board".

6.13.5.7 Closing the Add New Data Popup Screen

Use any of the following methods to close the add new data popup screen.

Methods to close the screen
This adds new PLC data.
Press the [CLOSE] menu key.
Press the left arrow key.
Press the [ESC] key on the software keyboard.

6.13.6 Delete Data Popup Screen

6.13.6.1 Outline

This enables PLC data stored in the current project to be deleted.

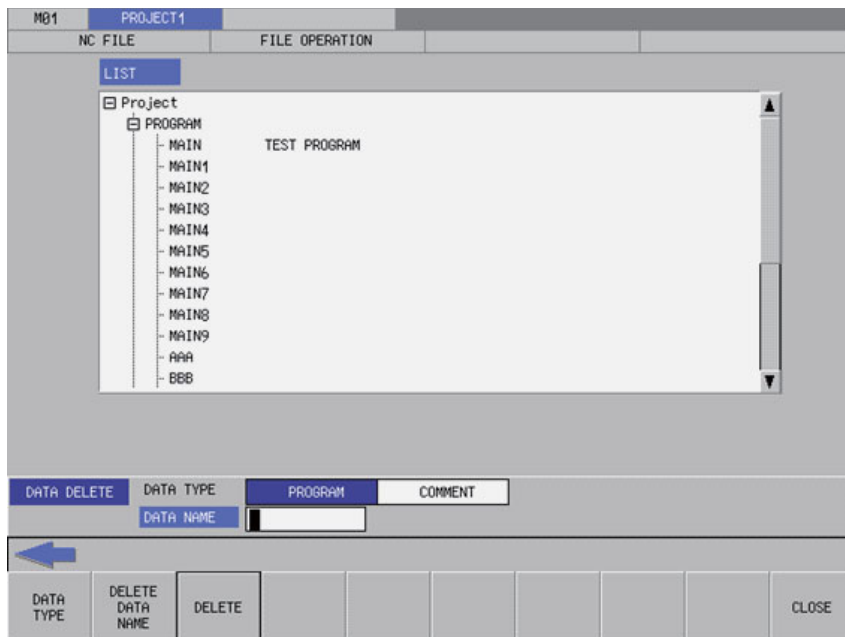

6.13.6.2 Screen Display Items

The following table describes the screen display items for the delete data popup screen.

Item name	Display state
Data type	This displays programs and comments. Programs are the default selection.(*1)
Data name	This is left blank.(*1) These are restricted to a maximum of 8 single-byte alphanumeric numeric characters.(*2)

(*1) Selecting data of different types (program and comments) from the list on the file operation screen and displaying this data on the delete data screen causes the data type and data name of the selected data to be selected and displayed.

(*2) Refer to "6.6.1 PLC Data Used by the PLC On-board" for information on restrictions to PLC data names and titles.

6.13.6.3 Enabled/Disabled State of Menu Keys

The menu keys displayed on the delete data popup screen are always enabled.

6.13.6.4 Status during Screen Displays

The following table describes the status when displaying the delete data popup screen.

Item name	Operation
Data type	This is the default focus position when the screen is displayed. This selects either programs or the data type of selected data.
Data name	This selects either blank displays or the data names of selected data.

6.13.6.5 Operation of Key Presses

The following table describes the operation of each menu key and the keys on the NC keyboard when pressed.

Item name	Operation
Left arrow key	Refer to "6.13.6.7 Closing the Delete Data Popup Screen".
Data type	This selects either the data type selection field or changes the data type selection.
Data name	This selects the data name input field.
Delete	Refer to "6.13.6.6 Deleting PLC Data".
Close	Refer to "6.13.6.7 Closing the Delete Data Popup Screen".

6.13.6.6 Deleting PLC Data

Normal operation

- Press the [DATA TYPE] menu key and select the data type you want to delete from the data type selection field.
- Press the [DATA NAME] menu key and enter the desired PLC data name into the data name input field.
- Press the [DELETE] menu key. Press the delete menu key to display the confirm delete message. If [YES] is selected, the confirm delete message and the delete data popup screen closes and the data is deleted. The name of the deleted PLC data is removed from the list on the file operation screen. If [NO] is selected, the confirm delete message closes and then the system returns to the delete data popup screen.

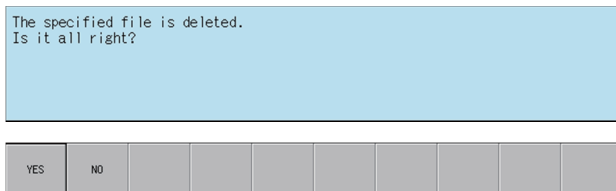

If a password to protect against reads or reads/writes has been registered to the selected files, the cancel password screen is displayed.

Enter the password to cancel the password.

If the password is canceled, processing will continue.

Refer to "6.21 Canceling File Passwords" for information on clearing passwords.

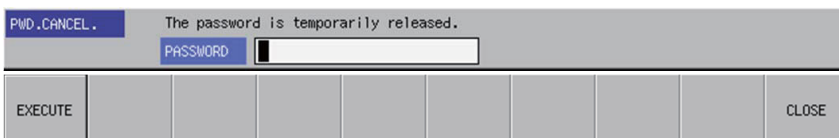

6 Explanation of Built-in Editing Function (PLC On-board)

6.13 NC File Operation Menus

If PLC data is deleted while the PLC is running, a message confirming whether or not to pause the PLC is displayed. Select [YES] to stop the PLC and continue deleting the PLC data. If [NO] is selected, an error occurs since the PLC is not stopped and the error message is displayed. (Refer to "Abnormal operation")

If the PLC stops, a message displays to confirm whether or not to restart the PLC immediately after data has been deleted. Select [YES] to continue running the PLC, or select [NO] to keep the PLC stopped.

PLC is in a RUN state.
Is data deletion performed after stop PLC?

YES	NO									
-----	----	--	--	--	--	--	--	--	--	--

PLC is in a STOP state.
Is PLC changed into a RUN state?

YES	NO									
-----	----	--	--	--	--	--	--	--	--	--

Abnormal operation

This information describes the details of error messages displayed on the delete data popup screen and the corrective action thereof.

Error message	Error details	Remedy
A data name has not been entered. Enter a data name.	This is displayed when the [DELETE] menu key is pressed while the data name input field is still blank.	Enter a valid data name before pressing the [DELETE] menu key.
A file was specified which does not exist in the NC.	This is displayed when the [DELETE] menu key is pressed after specifying a data type or data name in the data name input field that is not stored in the NC.	Press the [DELETE] menu key after specifying a data type or data name in the data name that is stored in the NC.
Data cannot be deleted because the PLC is running. Execute again after the PLC stops.	This is displayed when trying to delete data without stopping the PLC.	Delete data when the PLC is not running.

6.13.6.7 Closing the Delete Data Popup Screen

Use any of the following methods to close the delete data popup screen.

Methods to close the screen
Delete PLC data.
Press the [CLOSE] menu key.
Press the left arrow key.
Press the [ESC] key on the software keyboard.

6.13.7 Rename Data Popup Screen

6.13.7.1 Outline

This enables the name of PLC data stored in the current project to be changed.

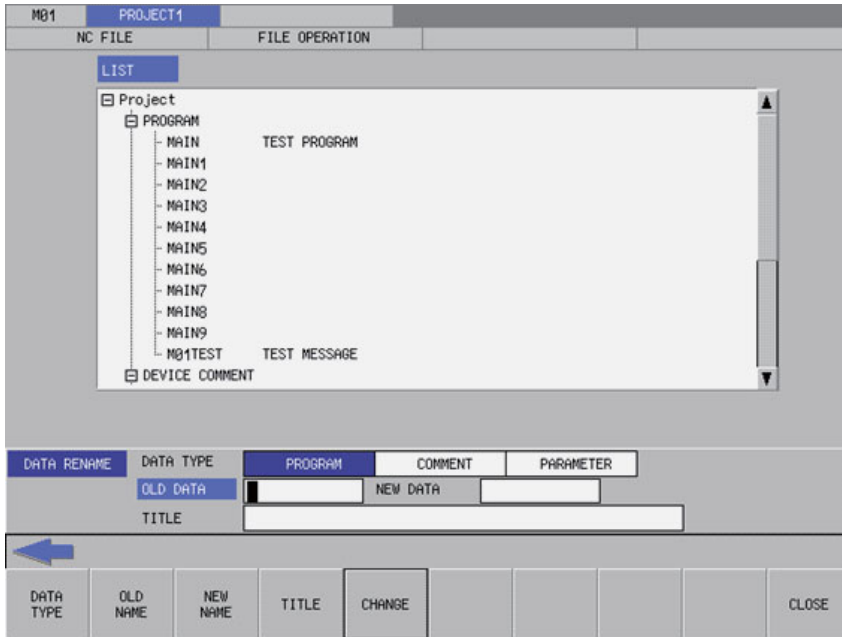

6.13.7.2 Screen Display Items

The following table describes the screen display items for the rename data popup screen.

Item name	Display state
Data type	This displays programs, comments, and parameters. Programs are the default selection.(*1)
Old data name	This is left blank.(*1) These are restricted to a maximum of 8 single-byte alphanumeric numeric characters.(*2)
New data name	This is left blank. These are restricted to a maximum of 8 single-byte alphanumeric numeric characters.(*2)
Title	This is left blank. These are restricted to a maximum of 8 single-byte alphanumeric numeric characters.(*2)

(*1) Selecting data of different types (program, comments, and parameters) from the list on the file operation screen and displaying this data on the rename data screen causes the data type and data name of the selected data to be selected and displayed. If parameter data is selected, however, characters cannot be entered into blank fields for old data names and new data names.

(*2) Refer to "6.6.1 PLC Data Used by the PLC On-board" for information on restrictions to PLC data names and titles.

6.13.7.3 Enabled/Disabled State of Menu Keys

The following information describes the conditions upon which menu keys displayed on the rename data popup screen are enabled/disabled.

The menu keys which are not described in the following table are always enabled.

Menu name	Condition upon which it is enabled/disabled
Old data name	Enabled when data type is other than parameter.
New data name	Enabled when data type is other than parameter.

6.13.7.4 Status during Screen Displays

The following table describes the status when displaying the rename data popup screen.

Item name	Operation
Data type	This is the default focus position when the screen is displayed. This selects either programs or the data type of selected data.
Old data name	This selects either blank displays or the data names of selected data. If the data type is parameter, data input is disabled for blank fields.
New data name	This is left blank. If the data type is parameter, data input is disabled for blank fields.
Title	This selects either blank fields or the titles of selected data.

6.13.7.5 Operation of Key Presses

The following table describes the operation of each menu key and the keys on the NC keyboard when pressed.

Item name	Operation
Left arrow key	Refer to "6.13.7.7 Closing the Rename Data Name Popup Screen".
Data type	This selects either the data type selection field or changes the data type selection.
Old data name	This selects the old data name input field.
New data name	This selects the new data name input field.
Title	This selects the title input field.
Change	Refer to "6.13.7.6 Renaming the PLC Data".
Close	Refer to "6.13.7.7 Closing the Rename Data Name Popup Screen".

6.13.7.6 Renaming the PLC Data

Normal operation

- Press the [DATA TYPE] menu key and select the data type you want to change from the data type selection field.
- Press the [DATA NAME] menu key and enter the current PLC data name into the old data name input field.
- Press the [DATA NAME] menu key and enter the new PLC data name into the new data name input field.
- Press the [CHANGE] menu key. Pressing the [CHANGE] menu key closes the rename data popup screen and changes the data name. The old PLC data name is removed from the list on the file operation screen and the new PLC data name is displayed.

If a password to protect against reads or reads/writes has been registered to the selected data, the cancel password screen is displayed.

Enter the password to cancel the password.

If the password is canceled, processing will continue.

Refer to "6.21 Canceling File Passwords" for information on clearing passwords.

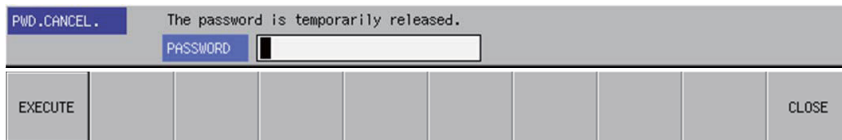

6 Explanation of Built-in Editing Function (PLC On-board)

6.13 NC File Operation Menus

If PLC data names are changed while the PLC is running, a message confirming whether or not to pause the PLC is displayed. Select [YES] to stop the PLC and continue changing the PLC data name. If [NO] is selected, an error occurs since the PLC is not stopped and the error message is displayed. (Refer to "Abnormal operation")

If the PLC stops, a message displays to confirm whether or not to restart the PLC immediately after the data name has been changed. Select [YES] to continue running the PLC. Select [NO] to keep the PLC stopped.

PLC is in a RUN state.
Is data name change performed after stop PLC?

YES	NO									
-----	----	--	--	--	--	--	--	--	--	--

PLC is in a STOP state.
Is PLC changed into a RUN state?

YES	NO									
-----	----	--	--	--	--	--	--	--	--	--

Abnormal operation

This information describes the details of error messages displayed on the rename data popup screen and the corrective action thereof.

Error message	Error details	Remedy
An old data name has not been inputted. Please input an old data name.	This is displayed when the [CHANGE] menu key is pressed while the old data name input field is still blank.	Enter a valid old data name before pressing the [CHANGE] menu key.
Please input a new data name. Enter the new data name.	This is displayed when the [CHANGE] menu key is pressed while the new data name input field is still blank.	Enter a valid new data name before pressing the [CHANGE] menu key.
This project/data name is a reserved device name. Please choose another name.	This is displayed after the [CHANGE] menu key is pressed when a reserved device name (*1) has been entered as the old data name or the new data name.	Enter a valid old data name or new data name before pressing the [CHANGE] menu key.
Prohibited characters were used in the file name. Do not use the following characters in file names: /, : , ; , * , ? , \ , " , < , > ,	This is displayed after the [CHANGE] menu key is pressed and the old data name or the new data name contains prohibited characters (*1).	Enter a valid old data name or new data name before pressing the [CHANGE] menu key.
File name includes the multi-byte character code. Please confirm file name.	This is displayed after the [CHANGE] menu key is pressed and the old data name or the new data name contains double-byte characters.	Enter a valid old data name or new data name before pressing the [CHANGE] menu key.
Illegal characters have been used for a data name. Use legal characters.	This is displayed after the [CHANGE] menu key is pressed and the final character of the old data name or the new data name is a period.	Enter a valid old data name or new data name before pressing the [CHANGE] menu key.
A file was specified which does not exist in the NC.	This is displayed when the [CHANGE] menu key is pressed after specifying a data type or data name that is not stored in the NC.	Press the [CHANGE] menu key after specifying a data type or data name in the data name that is stored in the NC.
The same data name has already been set. Change to a different data name.	This is displayed when the [CHANGE] menu key is pressed after specifying a new data name that already exists.	Specify a new data name that does not exist in the NC before pressing the [CHANGE] menu key.
Data names for device comments cannot be changed.	This is displayed when the [CHANGE] menu key is specified after a comment is specified for the old data name.	Specify something other than a comment for the old data name and press the [CHANGE] menu key.
It cannot change into the same name as a common device comment. Please choose another name.	This is displayed when the [CHANGE] menu key is specified after a comment is specified for the new data name.	Specify something other than a comment for the new data name and press the [CHANGE] menu key.
Data name cannot be changed because the PLC is running. Execute again after the PLC stops.	This is displayed when trying to change data names without stopping the PLC.	Change data names when the PLC is not running.

(*1) Refer to "6.6.1 PLC Data Used by the PLC On-board".

6.13.7.7 Closing the Rename Data Name Popup Screen

Use any of the following methods to close the rename data popup screen.

Methods to close the screen
Change the data name.
Press the [CLOSE] menu key.
Press the left arrow key.
Press the [ESC] key on the software keyboard.

6.13.8 Format Popup Screen

6.13.8.1 Outline

This is used to format the temporary storage area in the NC.

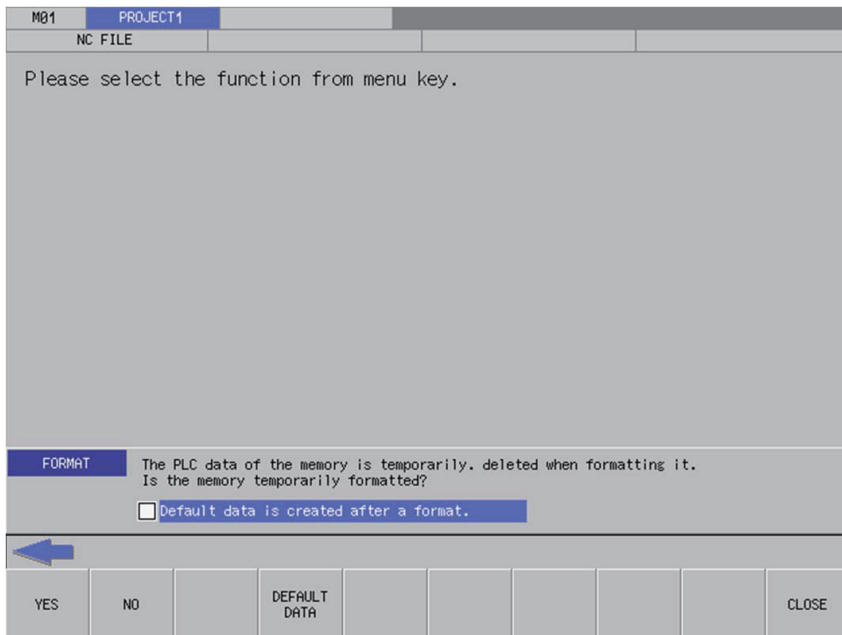

6.13.8.2 Screen Display Items

The following table describes the screen display items for the format popup screen.

Item name	Display state
Create default data after formatting	This is displayed with the check box not selected. Hidden when operation mode of the project is GX Works2.

6.13.8.3 Default Data

If the [Create default data after formatting] check box in the format popup screen is selected, the following PLC data is created after formatting the temporary storage area in the NC.

Data classification	Data name	Description
Program	MAIN	Blank program with only an END instruction
Parameter	PARAM	Parameters inherited from device settings for the formatted project.

A project created with default data is handled as a project without labels.

6.13.8.4 Enabled/Disabled State of Menu Keys

The following table describes the conditions upon which menu keys displayed on the FORMAT popup screen are enabled/disabled. Menu keys not displayed in the following table is always enabled.

Menu name	Condition upon which it is enabled/disabled
Default Data	Enabled when operation mode of the project is GX Developer. Hidden when operation mode of the project is GX Works2.

6.13.8.5 Status during Screen Displays

The following table describes the status when displaying the format popup screen.

Item name	Display state
Create default data after formatting	This is displayed with the check box not selected. Hidden when operation mode of the project is GX Works2.

6.13.8.6 Operation of Key Presses

The following table describes the operation of each menu key and the keys on the NC keyboard when pressed.

Item name	Operation
Left arrow key	Refer to "6.13.8.8 Closing the Format Popup Screen".
Yes	Refer to "6.13.8.7 Formatting the Temporary Memory Area in the NC".
No	Closes the format popup screen and transitions to the file operation screen.
Default Data	Selects the selection field to create the default data or changes the selection to create the default data.
Close	Refer to "6.13.8.8 Closing the Format Popup Screen".

6.13.8.7 Formatting the Temporary Memory Area in the NC

Normal operation

- (1) Press the [DEFAULT DATA] menu key to select whether or not to create the default data after formatting.
- (2) Press the [YES] menu key to format the temporary memory area. If the create default data setting is configured, the default data is created after formatting. After the process is complete, the format popup screen closes.

Abnormal operation

This information describes the details of error messages displayed on the format popup screen and the corrective action thereof.

Error message	Error details	Remedy
Write executions cannot be performed because the PLC is running. Execute again after the PLC stops.	This is displayed when trying to format memory without stopping the PLC.	Format memory when the PLC is not running.

6.13.8.8 Closing the Format Popup Screen

Use any of the following methods to close the format popup screen.

Methods to close the screen
Format the memory.
Press the [CLOSE] menu key.
Press the left arrow key.
Press the [ESC] key on the software keyboard.

6.13.9 ROM Write Popup Screen

6.13.9.1 Outline

This is used to store PLC data stored in the temporary memory area inside the NC into an SD card.

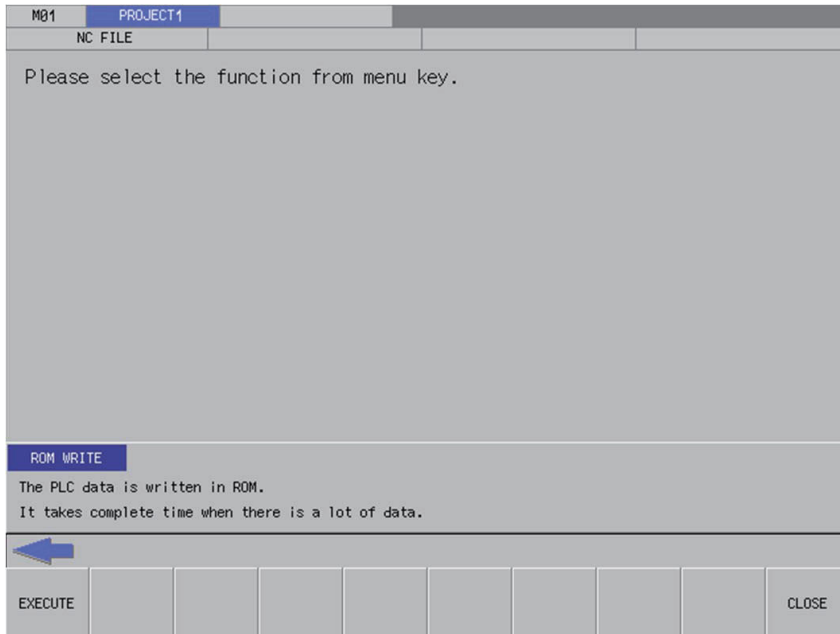

6.13.9.2 Screen Display Conditions

If automatic ROM write is set, the ROM write menu is not displayed in the NC file operation menu.

6.13.9.3 Enabled/Disabled State of Menu Keys

The menu keys displayed on the ROM write popup screen are always enabled.

6.13.9.4 Operation of Key Presses

The following table describes the operation of each menu key and the keys on the NC keyboard when pressed.

Item name	Operation
Left arrow key	Refer to "6.13.9.6 Closing the ROM Write Screen".
Execute	Refer to "6.13.9.5 Writing PLC Data in the Temporary Memory Area into ROM".
Close	Refer to "6.13.9.6 Closing the ROM Write Screen".

6.13.10 PLC RUN/STOP Popup Screen

6.13.10.1 Outline

This displays the current PLC state (running or stopped) and enables run and stop control of the PLC. The current status display on the screen changes depending on whether the PLC is currently running or is stopped.

The PLC RUN/STOP popup screen can be called from several different screens.

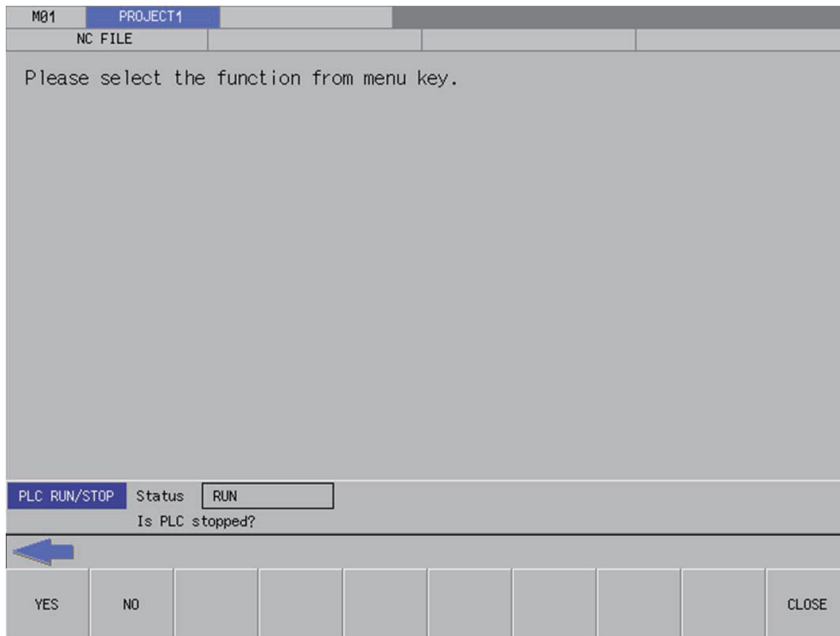

6.13.10.2 Screen Display Menus

The PLC RUN/STOP popup screen can be displayed from the following menus.

- [NC FILE OPERATION] - [PLC RUN/STOP]
- [EXT. FILE OPERATION] - [PLC RUN/STOP]
- [LADDER MONITOR] - [PLC RUN/STOP]
- [LADDER MONITOR] - [FB INSTANCE MONITOR] - [PLC RUN/STOP]
- [LADDER MONITOR] - [SPLIT SCREEN] - [ENTRY DEVICE MONITOR] - [PLC RUN/STOP]
- [LADDER MONITOR] - [SPLIT SCREEN] - [ENTRY LADDER MONITOR] - [PLC RUN/STOP]
- [DEVICE] - [DEVICE BATCH MONITOR] - [PLC RUN/STOP]
- [DEVICE] - [ENTRY DEVICE MONITOR] - [PLC RUN/STOP]
- [SAMPLING TRACE] - [TRACE EXECUTION] - [PLC RUN/STOP]

6.13.10.3 Screen Display Items

The following table describes the screen display items for the PLC RUN/STOP popup screen.

Item name	Display state
Current state	This displays the PLC state for the current project.

6.13.10.4 Enabled/Disabled State of Menu Keys

The menu keys displayed on the PLC RUN/STOP popup screen are always enabled.

6.13.10.5 Operation of Key Presses

The following table describes the operation of each menu key and the keys on the NC keyboard when pressed.

Item name	Operation
Left arrow key	Refer to "6.13.10.7 Closing the PLC RUN/STOP Popup Screen".
Yes	Refer to "6.13.10.6 Changing the PLC State for the Specified Project".
No	Refer to "6.13.10.7 Closing the PLC RUN/STOP Popup Screen".
Close	Refer to "6.13.10.7 Closing the PLC RUN/STOP Popup Screen".

6.13.10.6 Changing the PLC State for the Specified Project

To run

- Press the [YES] menu key to run the PLC for the specified project. PLC may not run depending on the ladder status, parameter settings, or other factors.

To stop

- Press the [YES] menu key to stop the PLC for the specified project.

6.13.10.7 Closing the PLC RUN/STOP Popup Screen

Use any of the following methods to close the PLC RUN/STOP popup screen.

Methods to close the screen
Press the [YES] menu key.
Press the [NO] menu key.
Press the [CLOSE] menu key.
Press the left arrow key.
Press the [ESC] key on the software keyboard.

6.13.11 Cancel Password Popup Screen

6.13.11.1 Outline

Passwords registered to PLC data files stored in the NC can be temporarily canceled.

Cancel password popup screen

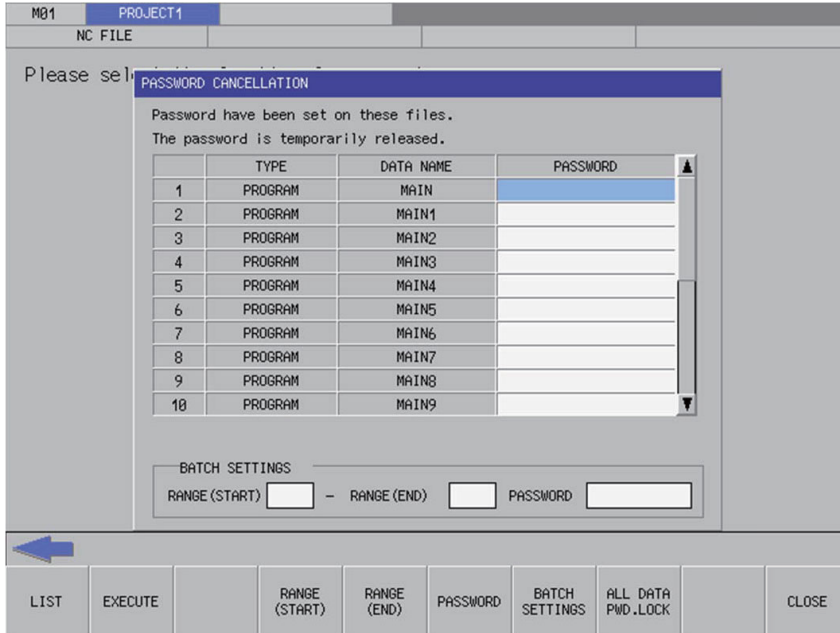

6.13.11.2 Screen Display Items

The following table describes the screen display items for the cancel password popup screen.

Item name		Display state
Type		This displays the type of file for which the password is cleared.
Data name		This displays the name of the file for which the password is cleared.
Password		Entered passwords are displayed on-screen using asterisks.
Batch settings	Range start	Enter the start number for batch settings. Input range: 001 to 999 (highest number)
	Range end	Enter the end number for batch settings. Input range: 001 to 999 (highest number)
	Password	Enter the password for batch settings. Input range: 4 single-byte alphanumeric characters

6.13.11.3 Enabled/Disabled State of Menu Keys

The following information describes the conditions upon which menu keys displayed on the cancel password popup screen are enabled/disabled.

The menu keys which are not described in the following table are always enabled.

Menu name	Condition upon which it is enabled/disabled
PWD lock for all data	Enabled when the following menu keys are selected • [NC FILE OPERATION] - [PASSWORD CANCELLATION] • [EXT. FILE OPERATION] - [PASSWORD CANCELLATION]

6.13.11.4 Status during Screen Displays

The following table describes the status when displaying the cancel password popup screen.

Item name	Operation	
Type	If the file selected to have the password cleared exists, the file type is displayed. If it does not exist, the display is blank.	
Data name	If the file selected to have the password cleared exists, the file name is displayed. If it does not exist, the display is blank.	
Password	This is the default focus position when the screen is displayed. This is left blank.	
Batch settings	Range start	This displays the lowest number.
	Range end	This displays the highest number.
	Password	This is left blank.

6.13.11.5 Operation of Key Presses

The following table describes the operation of each menu key and the keys on the NC keyboard when pressed.

Item name	Operation
Left arrow key	Refer to "6.13.11.9 Closing the Cancel Password Popup Screen".
List	This sets the focus to the password.
Execute	Refer to "6.13.11.8 Canceling Passwords".
Range start	Batch settings: Sets the focus to the start of the range.
Range end	Batch settings: Sets the focus to the end of the range.
Password	Batch settings: Sets the focus is applied to the password.
Batch settings	This sets the password for the files set from the start of the range to the end of the range with the password set in [BATCH SETTINGS] - [PASSWORD]. Refer to "Batch input".
PWD lock for all data	This sets all files set with passwords to the password not entered state (password locked state). Refer to "Locking the Password for All Data".
Close	Refer to "6.13.11.9 Closing the Cancel Password Popup Screen".

6.13.11.6 Entering Passwords

Separate entry

Use the following procedure to enter the file password.

- (1) Press the [LIST] menu key to select the list.
- (2) Use the up/down arrow keys, Page Up key, and Page Down key to move to the password display column for the desired file.
- (3) Press the [INPUT] key to display the password input field at the bottom of the list and move the focus.



- (4) Enter the password and then press the [INPUT] key. Press the INPUT key to close the password input field. The password entered at the cursor position in the list is displayed using asterisks.
 - ♦ Passwords are displayed using asterisks as they are input.
- (5) Pressing the [CLOSE] menu key cancels the password being entered, closes the password input field, and returns to the cursor position to the list.

Batch input

Passwords can be cleared in batches if multiple files have the same password.

Use the following procedure to enter batch settings.

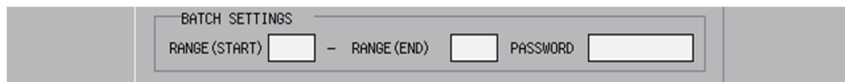

- (1) Press the [RANGE (START)] menu key to select the start of the range.
- (2) Enter the start number for batch settings.
- (3) Press the [RANGE (END)] menu key to select the end of the range.
- (4) Enter the end number for batch settings.
- (5) Press the [PASSWORD] menu key to select the password.
- (6) Enter the password for batch settings.
 - Passwords are displayed using asterisks as they are input.
- (7) Press the [BATCH SETTINGS] menu key. Pressing the batch settings key displays the password entered for the specified range using asterisks.
 - (*) Batch settings are enabled only when files are consecutively displayed in the list.

Abnormal operation

This information describes the details of error messages displayed when entering passwords and the corrective action thereof.

[Separate entry]

Error message	Error details	Remedy
A password has not been entered.	This is displayed when trying to confirm a password before entering the password.	Enter the password before confirming it.
The password is incorrect.	This is displayed when trying to confirm a password entered using less than 4 characters.	Correctly enter the 4-character password before confirming it.

[Batch input]

Error message	Error details	Remedy
The range start is not input.	This is displayed when the [BATCH SETTINGS] menu key is pressed before entering the start of the range.	Enter the start of the range before pressing the [BATCH SETTINGS] menu key.
The range end is not input.	This is displayed when the [BATCH SETTINGS] menu key is pressed before entering the end of the range.	Enter the end of the range before pressing the [BATCH SETTINGS] menu key.
A password has not been entered.	This is displayed when the [BATCH SETTINGS] menu key is pressed before entering the password.	Enter the password before pressing the [BATCH SETTINGS] menu key.
The range start is not input.	This is displayed when the [Batch Settings] menu key is pressed while the start of the range is not within the range of numbers in the list.	Edit the start of the range and then press the [Batch Settings] menu key again.
The range is illegal.	This is displayed when the [Batch Settings] menu key is pressed while the start of the range is higher than the end.	Edit the start of the range so that it is higher than the end and then press the [Batch Settings] menu key again.
The range end is illegal.	This is displayed when the [BATCH SETTINGS] menu key is pressed while the end of the range is not within the range of numbers in the list.	Edit the end of the range and then press the [BATCH SETTINGS] menu key again.
The password is incorrect.	This is displayed when the [BATCH SETTINGS] menu key is pressed while the password entered is less than 4 characters.	Edit the password with all 4 characters before pressing the [BATCH SETTINGS] menu key.

6.13.11.7 Deleting Passwords

Deleting entered passwords

- (1) Use the up/down arrow keys, Page Up key, and Page Down key to move to the password display column for the desired file.
- (2) Press the [DELETE] key. Pressing the [DELETE] key deletes the password at the cursor position.

Locking the password for all data

- (1) Press the [ALL DATA PWD. LOCK] menu key. Pressing the [ALL DATA PWD. LOCK] menu key displays the following message screen.

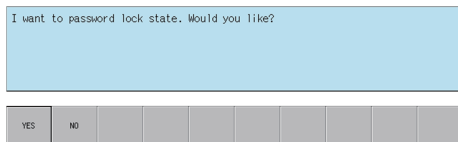

- (2) Pressing the [YES] menu key closes the message screen and resets all files to the password not set state (password locked state). The cancel password popup screen closes and the PLC data stored in the NC is retrieved again. Pressing the [NO] menu key closes the message screen and returns to the cancel password popup screen.

Locking the password for all data returns the block password to the password not entered state (password locked state).

6.13.11.8 Canceling Passwords

Normal operation

- (1) Press the [EXECUTE] menu key. Pressing this key removes successfully cleared files from the list. Files that were not successfully cleared remain displayed.
Files for which a password was not entered are also removed from the list as clearing the password for these files is no longer needed.

Abnormal operation

This information describes the details of error messages displayed on the cancel password popup screen and the corrective action thereof.

Error message	Error details	Remedy
The entered password is not correct. Enter correct password.	This is displayed when the [EXECUTE] menu key is pressed after entering an incorrect password.	The file for which an incorrect password was entered is displayed again. Enter the correct password and then press the [EXECUTE] menu key again.

6.13.11.9 Closing the Cancel Password Popup Screen

Use any of the following methods to close the cancel password popup screen.

Methods to close the screen
Press the [CLOSE] menu key.
Press the left arrow key.
Press the [ESC] key on the soft keyboard.

6.13.12 PLC Version Up Screen

6.13.12.1 Outline

The screen enables you to update the sequence programs, PLC messages, device comments and parameters in the NC temporary memory area with the files with the same name stored in an external device. It also performs ROM write in a batch. Store the target updated data for NC to the external device in advance. Since the storage destination of the updated data is fixed, only one NC is available. Refer to "6.13.13.5 Storing Method of the Updating Version Data" for the storage method.

If the PLC data is present in either the external device or the NC, the checkbox is grayed out in the tree diagram, thus the data cannot be updated.

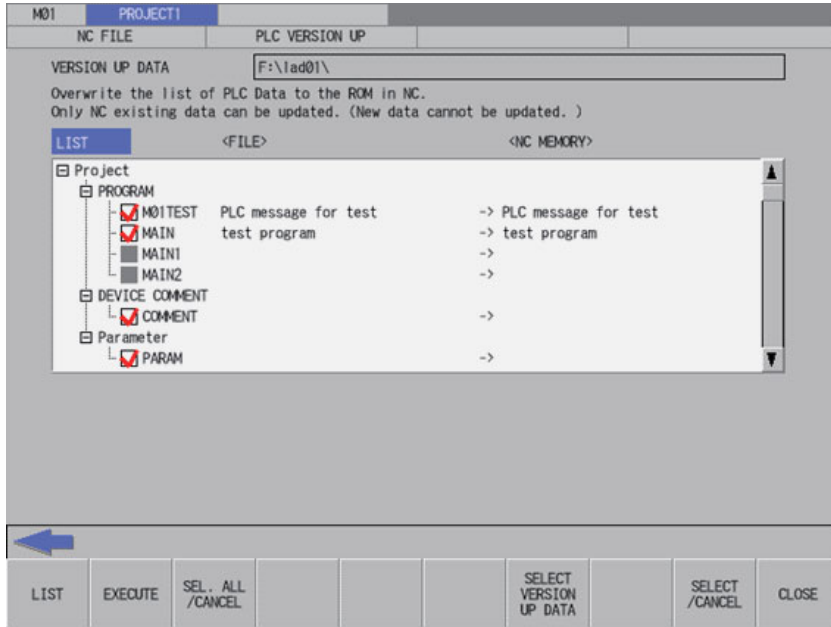

6 Explanation of Built-in Editing Function (PLC On-board)

6.13 NC File Operation Menus

Pressing the [PLC VERSION UP] menu from the NC file screen displays the select version up data popup screen as illustrated in the following diagram.

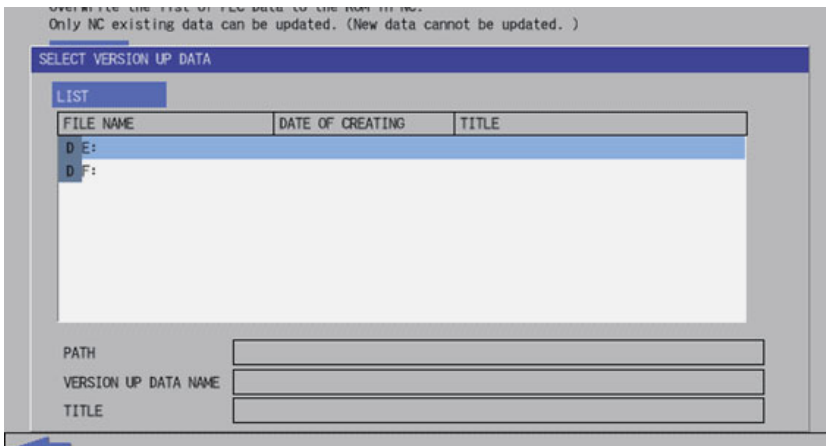

- ♦ The screen covers the data in the NC. Thus the PLC data cannot be added to the NC.
- ♦ The updating destinations are on-board editing area, temporary memory area and built-in ROM area as illustrated in "6.6.2 PLC Data Storage Areas".
- ♦ The PLC data displayed in the LIST are those stored in the temporary memory area. Thus if there is difference between the built-in ROM area and the temporary memory area as follows, the data is overwritten by that in the temporary memory area, and the difference on the built-in ROM area side is discarded.
 - When the PLC alarm message "WRITE LADDER TO ROM" is displayed
 - When you have not restarted the NC after restoring the backup data made with the PLC-related data all backup function.

Refer to "Procedures for Backing up Data Such as Sequence Programs" in "Peripheral Development Environment" for details of the PLC-related data all backup function.
- ♦ When using multiple projects, switch the current project in advance because the update is executed to the current project. Refer to "6.12.4 SELECT PROJECT" for the switching method.

6.13.12.2 Screen Display Items

The following table describes the screen display items on the PLC version up screen.

Item name	Display state
Connected NC name	This displays the name of the connected NC.
Current project No.	This displays the current project number.
Current project label	This displays the project label.
Alarm message	Alarm messages are displayed when alarms occur.
Left arrow key	This is displayed when enabled.
Software keyboard	This is displayed only when parameters are enabled.
Version up data	This displays the path of the updating version data selected on the select version up data popup screen.
List	This lists the sequence programs, PLC messages, device comments and parameters in the tree view, which are the results of comparison between the PLC data stored in the NC and those stored in the updating version data you selected on the "select version up data" popup screen.

6.13.12.3 Enabled/Disabled State of Menu Keys

The menu keys displayed on the PLC version up screen are always enabled.

6.13.12.4 Status during Screen Displays

The following table describes the status when displaying the PLC version up screen.

Item name	Display state
List	This is the default focus position when the screen is displayed. This lists the sequence programs, PLC messages, device comments and parameters in the tree view, which are the results of comparison between the PLC data stored in the NC and those stored in the updating version data. If there is nothing stored or no updating version data has been selected, this lists the PLC data of the NC in the tree view, with the setting operation of the sequence programs, PLC messages, device comments and parameters disabled.

6.13.12.5 Operation of Key Presses

The following table describes the operation of each menu key and the keys on the NC keyboard when pressed.

Item name	Operation
Left arrow key	This closes the PLC version up screen.
List	The focus is applied to the list.
Execute	Refer to "6.13.12.6 Update the PLC Version".
Select/cancel all data	This selects/deselects the check boxes for all data in the list.
Select version up data	This displays the select version up data popup screen. Refer to "6.13.13 Select Version Up Data Popup Screen" for details.
Select/cancel data	This selects/deselects the checkboxes for data selected in the list. This operation can also be performed with the [SP (space)] key.
Close	This closes the PLC version up screen.

6.13.12.6 Update the PLC Version

Normal operation

- (1) Select the updating version data from the select version up data popup screen.

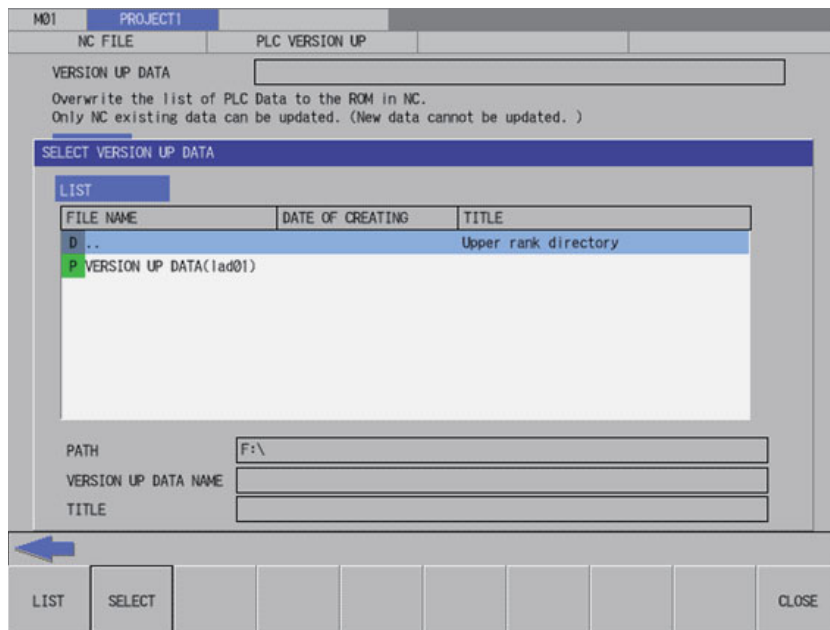

6 Explanation of Built-in Editing Function (PLC On-board)

6.13 NC File Operation Menus

(2) When selecting the updating version data, the data is compared to the temporary memory area of NC. If the both areas have the PLC data with the same name, the checkbox of the data is activated. If the PLC data exists in either of the areas, the checkbox of the data is deactivated.

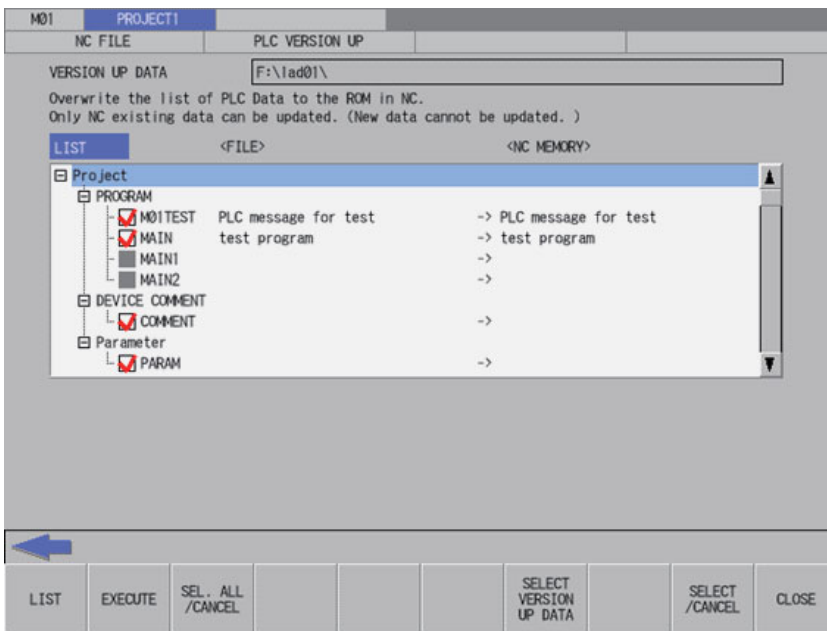
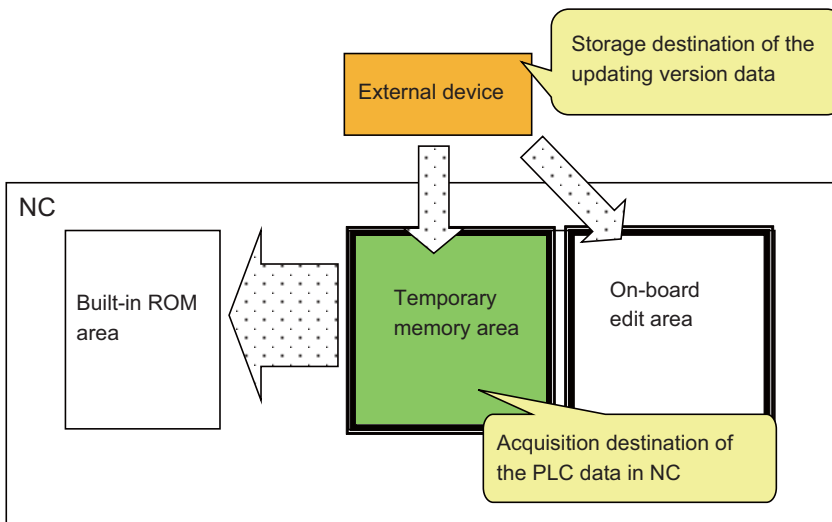

6 Explanation of Built-in Editing Function (PLC On-board)

6.13 NC File Operation Menus

- (3) If you exclude any PLC data from PLC version update, remove the check from the checkbox in the PLC version up screen list.

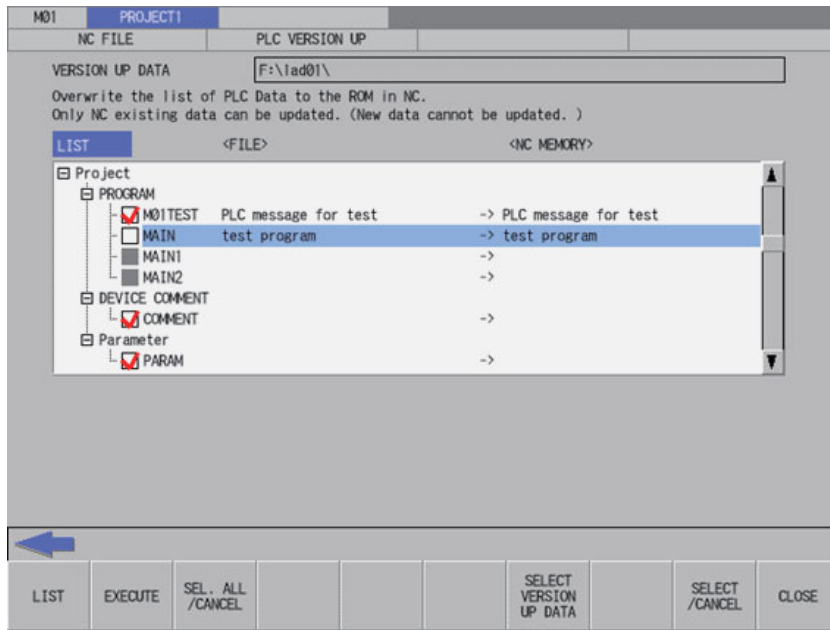

6 Explanation of Built-in Editing Function (PLC On-board)

6.13 NC File Operation Menus

- (4) After selecting data, press the [EXECUTE] menu key. The PLC data selected in the list is read from the external device and then the PLC data with the same name in the NC is overwritten.

If a password to protect against read or read and write has been registered to the selected files, the password cancel screen pops up.

Enter the password to temporarily cancel the password. If the password is temporarily cancelled, processing will continue. Refer to "Canceling File Passwords" for information on entering and clearing passwords.

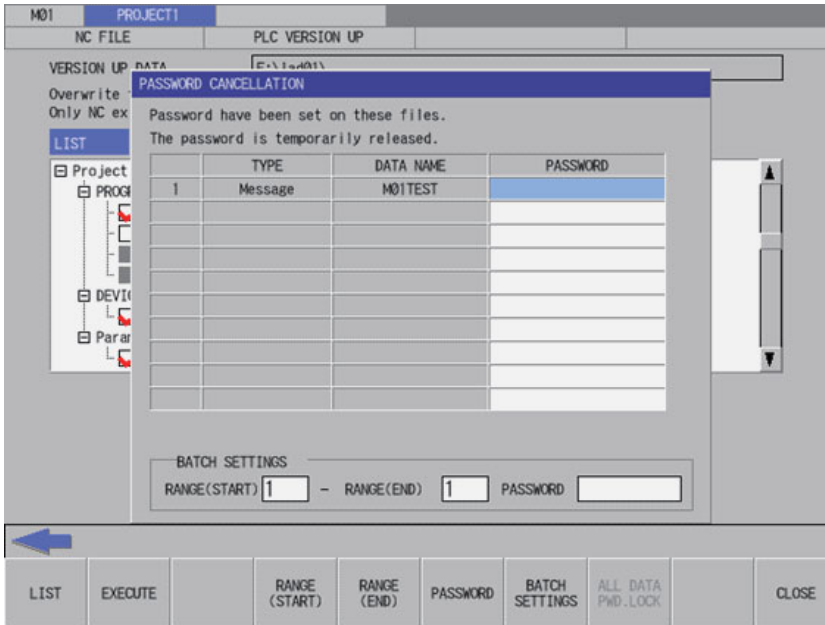

After the password is cleared, the operation to the PLC on-board is in the password cancel state. If necessary, enable the password lock state again by any of the following methods:

- Restart the NC
- Execute the password lock for all data (Refer to "Locking the password for all data" in "6.13.11.7 Deleting Passwords" for the methods.)

- (5) When the confirm start PLC version update popup screen is displayed, select "YES".



The progress bar appears, indicating the status of updating the PLC version.



- (*) Do not remove the external device while the progress bar is displayed. Failure to observe this may cause damage to the data in the NC or the external device, as the PLC version is not updated correctly.

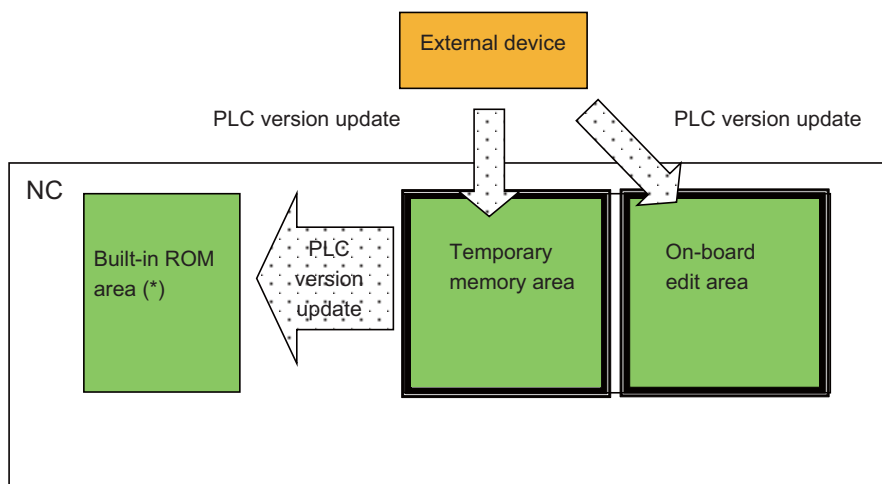

- (*) The built-in ROM area is overwritten with the temporary memory area for which PLC version update has been performed. Thus, if there is a difference between the two areas, the difference on the built-in ROM side is discarded. Refer to the precautions of "6.1 Outline" for details.

6 Explanation of Built-in Editing Function (PLC On-board)

6.13 NC File Operation Menus

- (6) After the PLC version update has been completed, the complete message is displayed. Press the OK button to automatically close the PLC version up screen and return to the NC file operation screen.

Complete.

OK									
----	--	--	--	--	--	--	--	--	--

If you update PLC version while the PLC is running, a message displays to confirm whether or not to pause the PLC. Select [YES] to stop the PLC and continue updating the PLC version. If [NO] is selected, an error occurs since the PLC is not stopped and the error message is displayed. (Refer to "Abnormal operation".)

If the PLC is stopped, a message displays to confirm whether or not to restart the PLC immediately before data has been added. Select [YES] to continue running the PLC, or select [NO] to keep the PLC stopped.

PLC is in the RUN state.
Do you want to execute the PLC version up after stopping PLC?

YES	NO								
-----	----	--	--	--	--	--	--	--	--

PLC is in a STOP state.
Is PLC changed into a RUN state?

YES	NO								
-----	----	--	--	--	--	--	--	--	--

Abnormal operation

This information describes the details of error messages displayed on the PLC version up screen and the corrective action thereof.

Error message	Error details	Remedy
A Version up Data is not selected.	This is displayed when you press the [EXECUTE] menu key without selecting any PLC data from the list.	Select PLC data from the list before pressing the [EXECUTE] menu key.
The version up cannot be executed because the PLC is running. Execute again after stopping the PLC.	This is displayed when you attempt to update the PLC data stored in the NC without stopping the PLC.	Update the PLC data stored in the NC after stopping the PLC.
The temporary data cannot be created in the specified drive. The following are possible causes. <ul style="list-style-type: none"> • The drive capacity is not enough. • The drive is write protected. • The directory for the temporary data "WorkTemp" already exists. 	When you use "Method for Directly Storing the PLC Data File in "ladXX" Directory" described in "6.13.13.5 Storing Method of the Updating Version Data" to store the updating version data, the temporary data directory "WorkTemp" is created in the storage destination. This message is displayed in the following cases. (1) The free capacity is insufficient. (2) The external device is write protected. (3) A directory or file named "WorkTemp" exists.	Perform the following for the external device that contains the updating version data, before updating the PLC data version. Increase the free capacity (For required free capacity, refer to "Method for Directly Storing the PLC Data File in "ladXX" Directory" in "6.13.13.5 Storing Method of the Updating Version Data".) (1) Release the write protection (2) Delete or rename the "WorkTemp" directory or file
A faulty command exist in the program. Execute a program check and correct the program.	This is displayed when you attempt to update the program containing any device No. which is out of the device range of the NC.	Check the device range and correct the program to be updated, so that all the devices in the program are within the range.
Device point that is set in parameter is not match the device point in NC. Continue the reading PLC or writing PLC?	This is displayed when the parameter file to be updated has different number of device points from that of the NC. When selecting [YES], reading of the parameter file is skipped and the update process is continued. When selecting [NO], the update process is cancelled.	When updating the version of parameter file, check the number of NC device points shown in "6.18.6 Device Settings Screen", and match the number.

6.13.12.7 Closing the PLC Version Up Screen

Use any of the following methods to close the PLC version up screen.

Methods to close the screen
Press the [CLOSE] menu key.
Press the left arrow key.
Press the [ESC] key on the software keyboard.

6.13.13 Select Version Up Data Popup Screen

6.13.13.1 Outline

This screen enables you to select the updating version data stored directly under the external device.

This function can read only the project created with PLC on-board or with GX Developer. A project created with GX Works2 cannot be read.

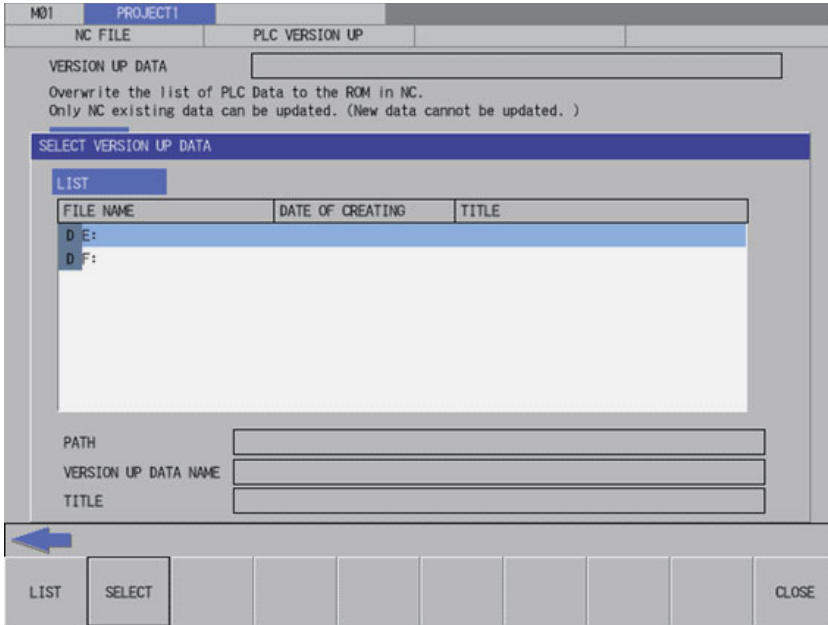

6.13.13.2 Screen Display Items

The following table describes the screen display items for the select version up data popup screen.

Item name	Display state
List	The File name column displays the external device list or the updating version data. The Date of creating column is always blank. The Title column displays the title set in the project when the selected data is in the project format.
Path	This displays the path where the updating version data is stored.
Version up data name	This displays the name of the updating version data that is selected in the list.
Title	This displays the title set in the project when the selected updating version data is in the project format.

6.13.13.3 Enabled/Disabled State of Menu Keys

The menu keys displayed on the select version up data popup screen are always enabled.

6.13.13.4 Status during Screen Displays

The following table describes the status when displaying the select version up data popup screen.

Item name	Operation
List	Refer to "6.13.13.6 Displaying Updating Version Data".
Path	This is blank or displays the path that is displayed in the List.
Version up data name	This is blank or displays the name of the updating version data that is selected in the list.
Title	This is blank or displays the title set in the project when the selected updating version data is in the project format.

6.13.13.5 Storing Method of the Updating Version Data

The updating version data is stored in the directory named "ladXX" that is located directly under the external device. ("XX" is a two-digit number representing the project No., from "01" to "06".)

The "ladXX" directory is located directly under the external device and is case-insensitive.

For a single project, store the data in "lad01" which is project No.1.

There are two storage methods, and the method to be stored in project format will have a priority.

A project created with PLC Works2 cannot be used on PLC update screen. Use a project created with GX Developer or PLC on-board.

Method for directly storing the PLC data file in "ladXX" directory

This is the method for directly storing the individually prepared PLC data in "ladXX" directory.

Storage example (Project No.1)

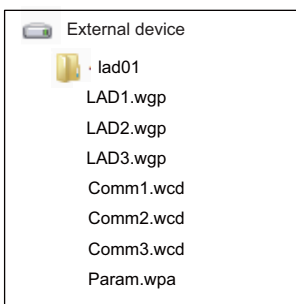

In this method, the temporary work directory "WorkTemp" is created when updating the PLC version directly under the "ladXX" directory and is deleted after the update.

The external device requires the following free capacity because the fixed file and the PLC data selected on the PLC version up screen are stored in "WorkTemp".

Free capacity to be required = Fixed file size (128 kilobytes) + PLC data file size

Method for storing project-format data in "ladXX" directory

This is the method for directly storing the project format directory for GX Developer to the "ladXX" directory. The project format directory name is fixed to "plcproj" and is case-insensitive.

Storage example (Project No.1)

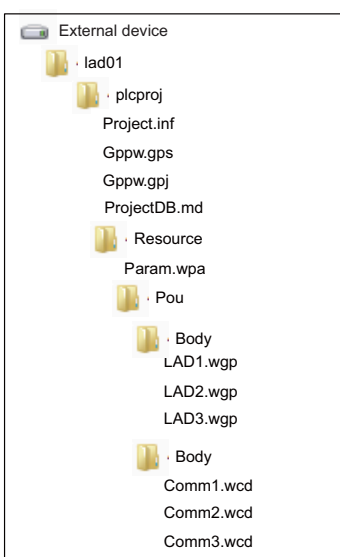

6.13.13.6 Displaying Updating Version Data

When the updating version data is stored directly under the external device, it is displayed as the fixed name "VERSION UP DATA (ladXX)" in the list of the select version up data popup screen. ("XX" is a two-digit number representing the project No., from "01" to "06".)

The updating version data is stored in the "ladXX" directory that is located directly under the external device. However, in the list of the select version up data popup screen, it is displayed as the item name "VERSION UP DATA (ladXX)".

Difference of the display according to the displaying timing

This displays the external device list when the select version up data popup screen is displayed for the first time.

This displays the updating version data previously selected when the select version up data popup screen is displayed after the data is already selected.

[List for the initial display of the screen]

FILE NAME	DATE OF CREATING	TITLE
■ E:		
■ F:		

[List when an updating version data was selected]

(Example) If you select and execute the updating version data stored in the external device F, the data of the external device F is displayed next time.

FILE NAME	DATE OF CREATING	TITLE
■ ..		Upper rank directory
P VERSION UP DATA(lad01)		

[List to be displayed next time]

FILE NAME	DATE OF CREATING	TITLE
■ ..		Upper rank directory
P VERSION UP DATA(lad01)		

6.13.13.7 Operation of Key Presses

The following table describes the operation of each menu key and the keys on the NC keyboard when pressed.

Item name	Operation
Left arrow key	This closes the select version up data popup screen.
Select	Refer to "6.13.13.8 Selecting Updating Version Data".
Close	This closes the PLC version up screen.

6.13.13.8 Selecting Updating Version Data

- Press the [LIST] menu key to move the focus to the list. Use the up and down arrow keys to select the external device where the updating version data is stored and press the [INPUT] key or the [SELECT] menu key.

FILE NAME	DATE OF CREATING	TITLE
■ ..		Upper rank directory
P VERSION UP DATA(lad01)		

- When you press the [INPUT] key or the [SELECT] menu key after selecting "VERSION UP DATA" with the up and down arrow keys, the select version up data popup screen closes and the PLC version up screen appears again. PLC version up screen lists the sequence programs, PLC messages, device comments and parameters in the tree view, which are the results of the comparison between each PLC data stored in the selected updating version data and those stored in the NC.

FILE NAME	DATE OF CREATING	TITLE
Project		
PROGRAM		
<input checked="" type="checkbox"/> M01TEST	PLC message for test	-> PLC message for test
<input checked="" type="checkbox"/> MAIN	test program	-> test program
MAIN1		->
MAIN2		->
DEVICE COMMENT		
<input checked="" type="checkbox"/> COMMENT		->
Parameter		
<input checked="" type="checkbox"/> PARAM		->

6.13.13.9 Closing the Select Version Up Data Popup Screen

Use any of the following methods to close the select version up data popup screen.

Methods to close the screen
Select the updating version data and then press the [SELECT] menu key.
Press the [CLOSE] menu key.
Press the left arrow key.
Press the [ESC] key on the software keyboard.

6.13.14 POU LIST screen

6.13.14.1 Outline

POU list contained in a project is displayed in the tree diagram for a project with labels or a structured project.

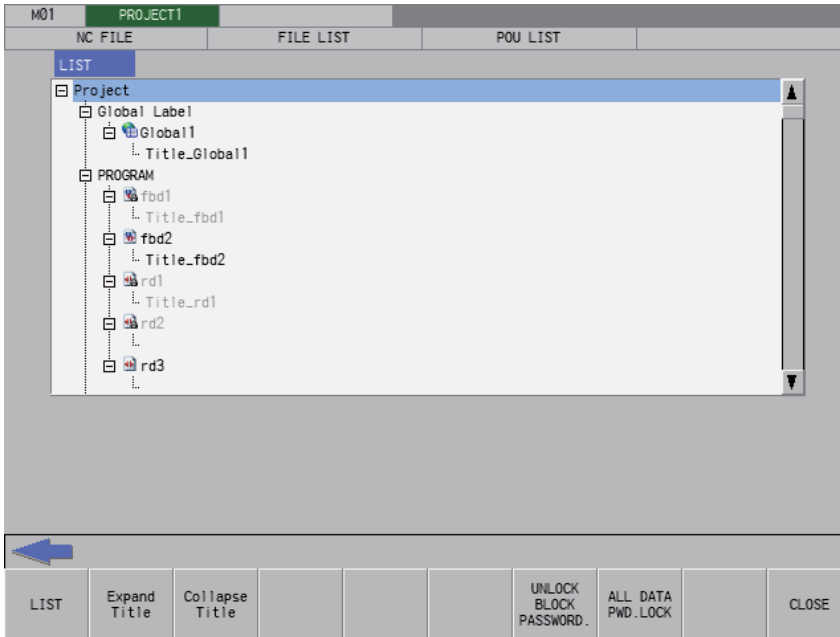

6.13.14.2 Screen Display Items

The following table describes the screen display items for the POU LIST screen.

Item name	Display state
List	Displays POU List. Refer to "6.13.14.6 Display" for details of display.

6.13.14.3 Enabled/Disabled State of Menu Keys

Menu keys displayed on POU LIST screen are enabled.

6.13.14.4 Status during Screen Displays

The following table describes the state when displaying the POU LIST screen.

Item name	Operation
List	This is the default focus position when the screen is displayed. Titles are hidden.

6.13.14.5 Operation of Key Presses

The following table describes the operation of each menu key and the keys on the CNC keyboard when pressed.









Item name	Operation
Left arrow key	This closes the POU list screen.
LIST	The focus is applied to the list.
Expand Title	This expands titles.
Collapse Title	This hides titles.
Block Password Disable	This displays the block password disable screen for the highlighted POU. (Refer to "6.15.11 Block Password Disable screen")
PWD lock for all data	This sets all files and blocks with passwords to the password not entered state (password locked state). (Refer to " Locking the password for all data")
Close	This closes the POU list screen.

6.13.14.6 Display





















This screen displays POU type as icons.

The following describes the list details.

■ Project with labels

POU			Icons
Project			-
	Global device comment		
	Global label		-
	Data name		
	Program		-
	Data name	Ladder	
		ST	
	FB_Pool		-
	Data name	Ladder	
		ST	
	Structured Data Types		-
	Data name		
	Language device comment		-
	Data name		

■ Structured project

POU		Icons
Project		-
	Global device comment	
	Global label	-
	Data name	
Program		-
	Data name	
	Ladder	
	ST	
	Structured ladder	
FB		-
	Data name	
	Ladder	
	ST	
	Structured ladder	
FUN		-
	Data name	
	ST	
	Structured ladder	
Structured Data Types		-
	Data name	
Language device comment		-
	Data name	
User Library (Library name)(*1)		-
	Global label	-
	Data name	
Program		-
	Data name	
	ST	
	Structured ladder	
FB		-
	Data name	
	ST	
	Structured ladder	
FUN		-
	Data name	
	ST	
	Structured ladder	
Structured Data Types		-
	Data name	

(*1) If there is no user library, it is not displayed.
 If there are multiple user libraries, they all are displayed.

6.13.14.7 Title

Each POU has a title (*1).

If the title is not set, it is displayed blank.

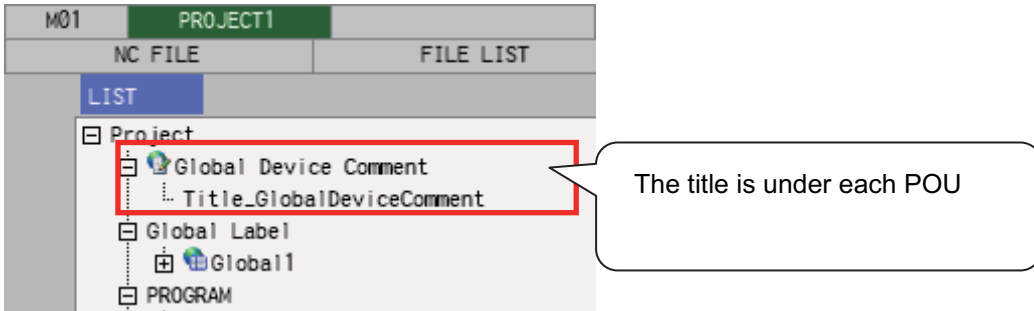

(*1) Set "Title" on GX Works2 or on each POU property.

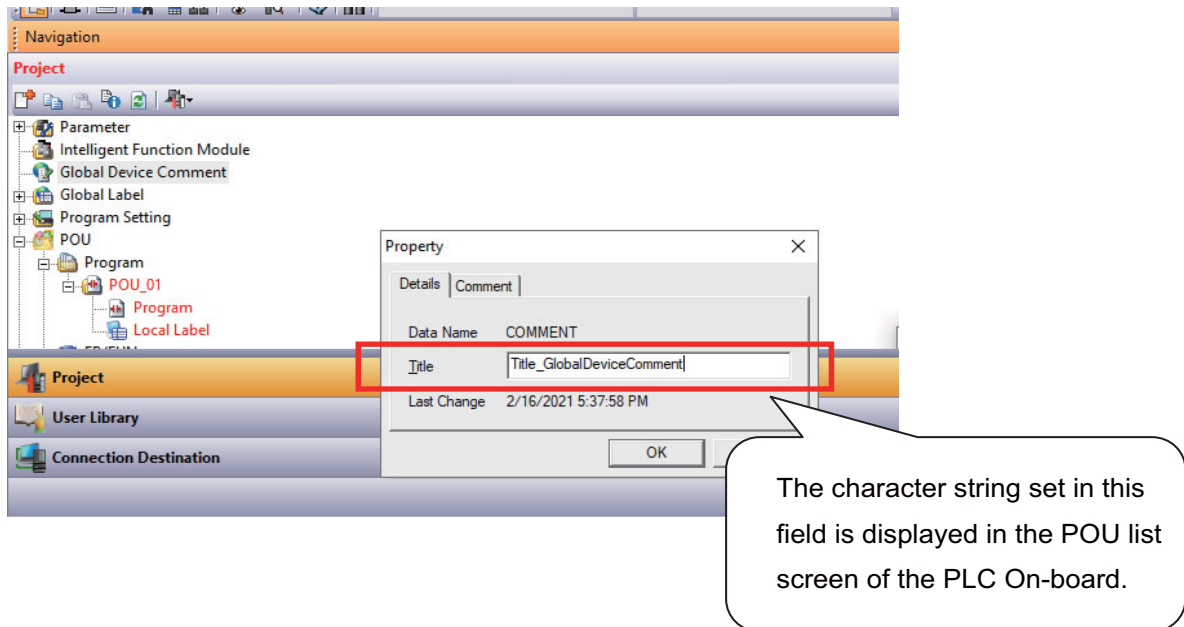

Only a title of POU is displayed on this screen and titles of project or user library are not displayed.

6.13.14.8 POU with Block Password

Icons have key marks and character color is gray for the POU with block password.

Refer to "6.6.3.2 Block Passwords for PLC Data" for block password.

■ With block password

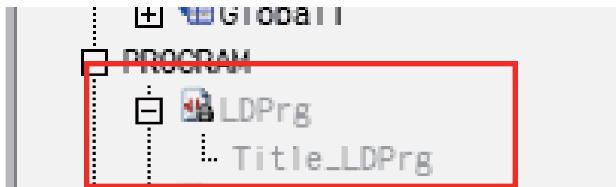

When the block password is disabled, icons do not have key marks and character color is black. (Same as the block password not set state)

■ When block password is disabled



Password can be set to user library on GX Works2 and the display of POU LIST screen does not differ regardless of settings of password.

■ Password setting screen for user library on GX Works2.

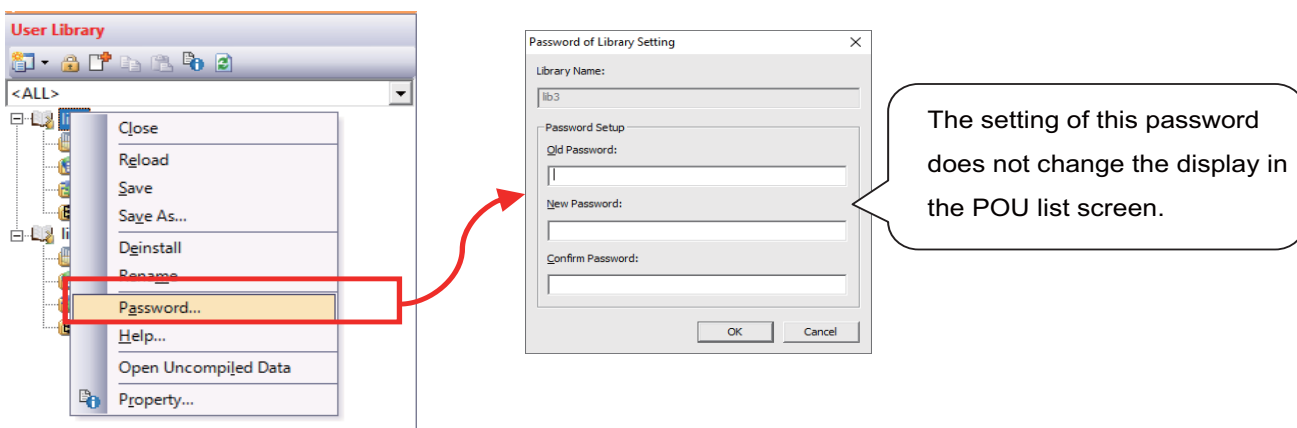

6.13.14.9 Block Password Disable

Normal operation

- (1) Highlight POU to be disabled.
- (2) Press the [Block Password Disable] menu.
- (3) This displays the block password disable screen for the selected POU.
- (4) Input the block password set in the selected POU.
- (5) Press the [Execute] menu and close the block password screen.

Refer to "6.15.11 Block Password Disable screen" for block password disable screen.

Abnormal operation

The following describes the details of error messages displayed when pressing [Block Password Disable] menu and remedy. Refer to "6.1.4 Language" for program language that can be displayed on ladder screen.

Error message	Error details	Remedy
Block password cannot be unlocked for the POU selected. Please select a POU that was created using the programming language supported by the ladder screen.	This message is displayed if other than POU with the following conditions is highlighted. <ul style="list-style-type: none"> • Created in a program language that can be displayed on ladder screen • Locked with block password 	Highlight POU that is locked with block password and created in a program language that can be displayed on ladder screen, then press the "Block Password Disable" menu key.

6.13.14.10 PWD Lock for All Data

This sets all files and blocks with passwords to the password not entered state for all.

Refer to " Locking the password for all data" for details.

Abnormal operation

This following describes the details of error messages displayed on POU LIST screen after locking all the passwords and corrective action.

Error message	Error details	Corrective Action
A program locked with the file password is included, so the list of POU's cannot be displayed.	When there is at least one file with file password locked in current project.	Disable all the file password on Password Disable screen.
Failed to read out: language settings do not match. Go to the GX Works2 Setting screen, and set the project language to be the same as that used to create the ladder.	This message is displayed when a language of a project stored in CNC and CNC language parameter do not match.	Set the CNC language parameter to be the same as that of project language, and read again.
Symbolic information and program file do not match, or symbolic information and PLC parameters were not read out at the same time. The project can not be read out: the project is in an uncompiled status.	This message is displayed in the following cases. <ul style="list-style-type: none"> • Symbolic information of a project with labels stored in CNC differ from the program file. • When executing "Open" with [Symbolic Information] checked and [Parameter] - [PC/Network] unchecked. 	Check and store only program files that match symbolic information. Store the PC parameters of projects with symbolic information in CNC, then execute "Open" with [Symbolic Information] and [Parameter] - [PC/Network] checked in the list.
Failed to read/write the project. The following may be the possible causes: <ul style="list-style-type: none"> • The project data is corrupted. • Insufficient memory • A ladder instruction not specified by this product is included. • Memory capacity is insufficient. • The selected project is read-only. 	This message is displayed when a project was not read/written.	Check the program stored in the CNC.
Device points set in the parameters and device points in NC do not match. The reading from PLC or writing to PLC is suspended.	This message is displayed when the device points set in the parameter does not match the device points of the CNC.	After having formatted the storage area once, you need to review the number of device points in PC parameter and multi-project parameter, and rewrite the ladder again.

6.14 External File Operation Menus

6.14.1 External File Operation Main Screen

This is used to perform operations on PLC data stored in external devices.

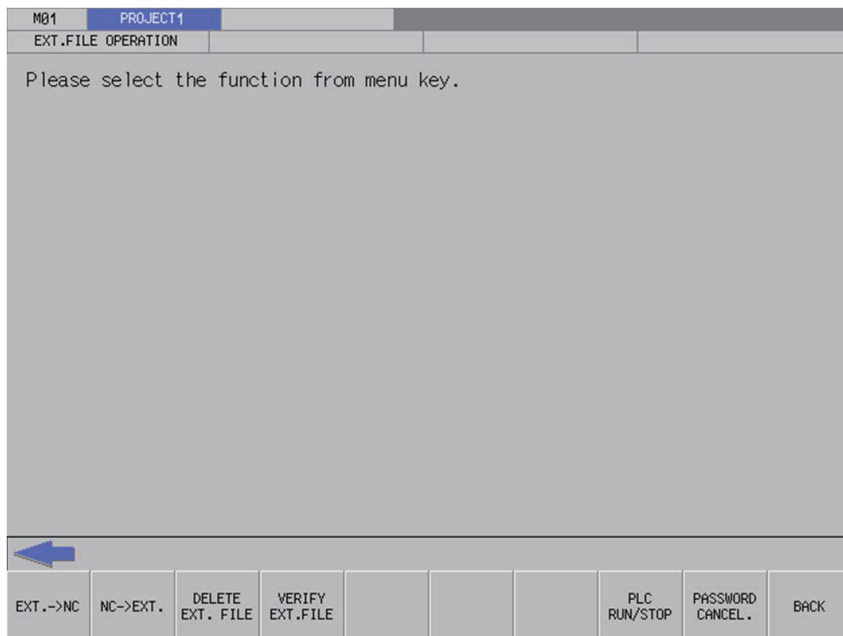

6.14.1.1 Screen Display Items

The following table describes the screen display items for the external file operation screen.

Item name	Display state
Connected NC name	This displays the name of the connected NC.
Current project No.	This displays the current project number.
Current project label	This displays the project label.
Alarm message	Alarm messages are displayed when alarms occur.
Left arrow key	This is displayed when enabled.
Software keyboard	This is displayed only when parameters are enabled.

6.14.1.2 Enabled/Disabled State of Menu Keys

The following table describes the conditions upon which menu keys displayed on the external file operation screen are enabled/disabled.

The menu keys which are not described in the following table are always enabled.

Menu name	Condition upon which it is enabled/disabled
EXT.->NC	Disabled when the function is restricted.
NC -> External	Disabled when the function is restricted.
DELETE EXT. FILE	Hidden when operation mode of the project is GX Works2.
VERIFY EXT. FILE	Hidden when operation mode of the project is GX Works2.
PLC RUN/STOP	Disabled when the function is restricted.
PASSWORD CANCEL.	Disabled when the function is restricted.

Operation of key presses

The following table describes the operation of the keys on the NC keyboard when pressed.

Item name	Operation
Left arrow key/return menu key	These transition to the main menu.
Various menu keys	This displays the specified screen.

6.14.2 "EXT." -> "NC" Screen

6.14.2.1 Outline

This reads the project data stored in external device and writes to the temporary memory area of the current project in the NC. Only GX Developer file or GX Works2 file can be written.

■ "EXT." -> "NC" screen display with GX Developer format

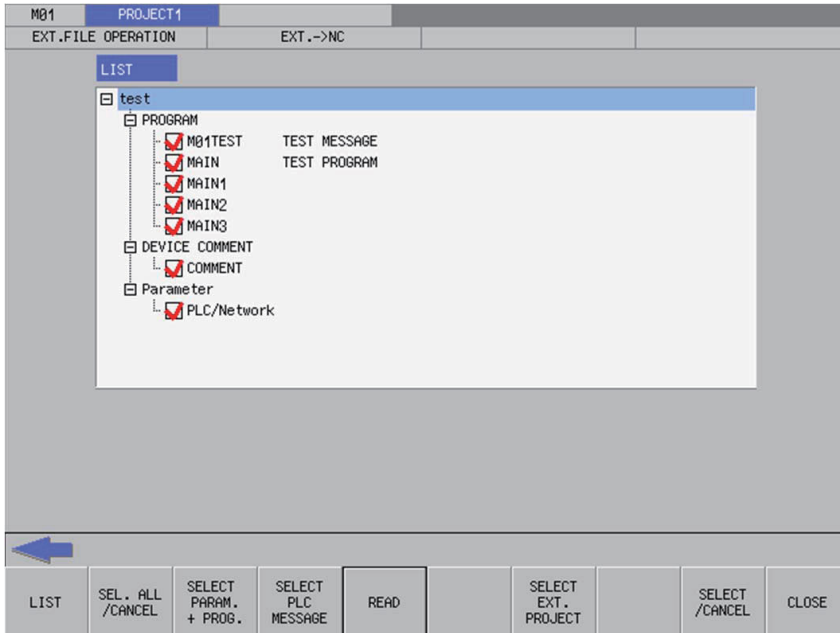

■ "EXT." -> "NC" screen display with GX Works2 format (for a project with labels or a structured project)

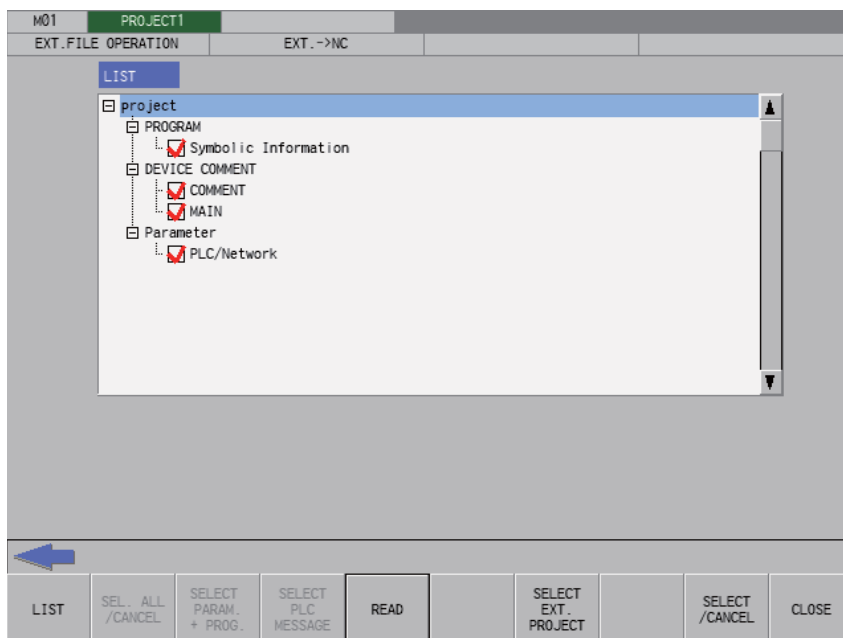

Screen display is the same as GX Developer for a GX Works2 project without labels.

6 Explanation of Built-in Editing Function (PLC On-board)

6.14 External File Operation Menus

Pressing the [EXT. -> NC] menu from the external file operation screen displays the select external project popup screen as illustrated in the following diagram. If this screen displays while an external project is not selected, PLC data cannot be displayed in the list.

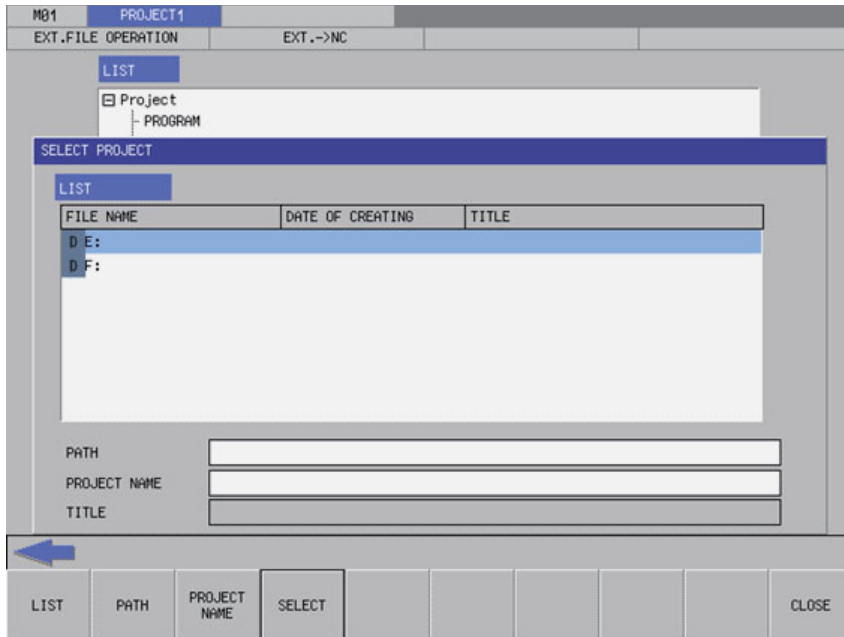

6.14.2.2 Screen Display Items

The following table describes the screen display items for the "EXT.->NC" screen.

Item name	Display state
Connected NC name	This displays the name of the connected NC.
Current project No.	This displays the current project number.
Current project label	This displays the project label.
Alarm message	Alarm messages are displayed when alarms occur.
Left arrow key	This is displayed when enabled.
Software keyboard	This is displayed only when parameters are enabled.
List	This displays PLC data stored in the selected on the select external project screen. This displays nothing if there is nothing stored or no PLC data has been selected.

6.14.2.3 Enabled/Disabled State of Menu Keys

The following table describes the conditions upon which menu keys displayed on the "EXT.->NC" screen are enabled/disabled.

The menu keys which are not described in the following table are always enabled.

Menu name	Condition upon which it is enabled/disabled
Select/cancel all data	Enabled when operation mode is GX Developer and selectable PLC data has been added to the list
Parameter + Program	Enabled when operation mode is GX Developer and selectable PLC data has been added to the list
PLC messages	Enabled when operation mode is GX Developer and selectable PLC data has been added to the list
Read	Enabled when selectable PLC data has been added to the list

6.14.2.4 Status during Screen Displays

The following table describes the status when displaying the "EXT.->NC" screen.

Item name	Operation
List	This is the default focus position when the screen is displayed. This displays PLC data stored in the selected on the select external project screen. This displays nothing if there is nothing stored or no PLC data has been selected.

6.14.2.5 Operation of Key Presses

The following table describes the operation of each menu key and the keys on the NC keyboard when pressed.

Item name	Operation
Left arrow key	Refer to "6.14.2.7 Closing the "EXT.->NC" Screen".
List	The focus is applied to the list.
Select/cancel all data	This selects/deselects the check boxes for all data in the list.
Parameter + Program	This checks the check boxes for parameters and programs in the list. This does not include PLC messages however.
PLC messages	This checks the check boxes for the PLC messages in the list.
Read	Refer to "6.14.2.6 Reading External Project Data and Storing in the NC".
Select external project	This displays the select external project popup screen. Refer to "6.14.3 Select External Project Popup Screen".
Select/cancel all data	This selects/deselects the check boxes for data selected in the list. This operation can also be performed with the [SP (space)] key.
Close	Refer to "6.14.2.7 Closing the "EXT.->NC" Screen".

6.14.2.6 Reading External Project Data and Storing in the NC

Normal operation

- Press the [LIST] menu key to move the focus to the list. Select the desired PLC data from the list. Deselect the check boxes for data you do not want to store.
(When operation mode is GX Works2, program (symbolic information) and parameters are enabled and cannot be disabled. Device comment can be selected separately.)
- Select data, then press the "Read" menu key. After pressing this menu key, the PLC data selected in the list is read from the project stored in an external device and then stored in the specified project in the NC.

When operation mode is GX Works2, PC parameters cannot be written if a project contains remote password.

Depending on operation mode, handling of PLC data differ when operating external file. Refer to "6.6.2.3 Handling of PLC Data during External File Operation" for details.

6 Explanation of Built-in Editing Function (PLC On-board)

6.14 External File Operation Menus

If a password to protect against reads or reads/writes has been registered to the selected files, the cancel password screen is displayed.

Enter the password to temporarily cancel the password.

If the password is temporarily cancelled, processing will continue.

Refer to "6.21 Canceling File Passwords" for information on entering and clearing passwords.

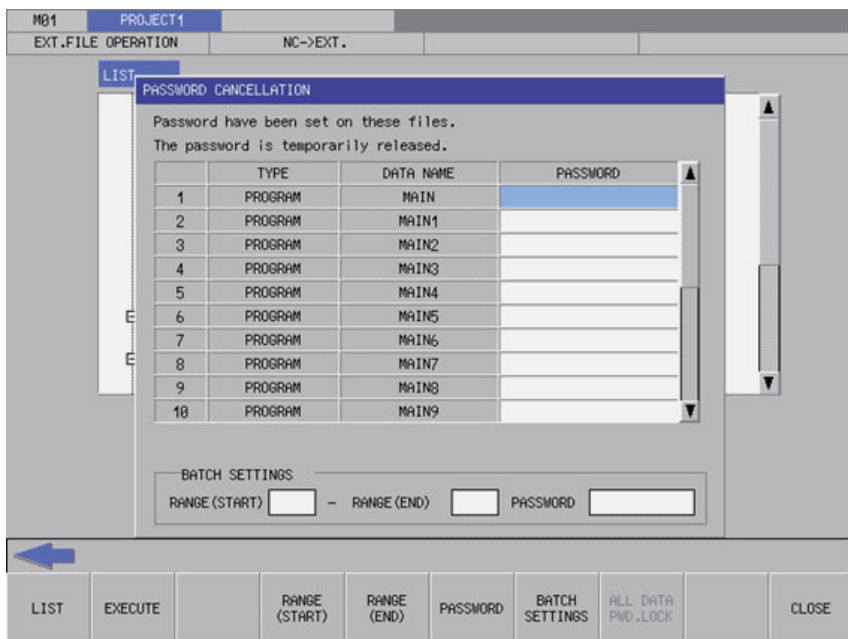

When a project with labels or a structured project is stored in external device, the data is read to CNC in symbolic information units. All the programs contained in symbolic information are stored in CNC. Programs cannot be stored in program file units.

A program file to be stored in CNC cannot be selected when a GX Works2 project without labels is stored in external device. All the programs contained in project are stored in CNC.

Disable the all passwords of stored file in CNC to store external project to CNC when operation mode is GX Works2. Refer to "6.21 Canceling File Passwords" for how to disable file passwords.

6 Explanation of Built-in Editing Function (PLC On-board)

6.14 External File Operation Menus

Data cannot be stored in CNC if user management is set by the security function of GX Works2. To store data, delete the user management with GX Works2, then store the project to external device.

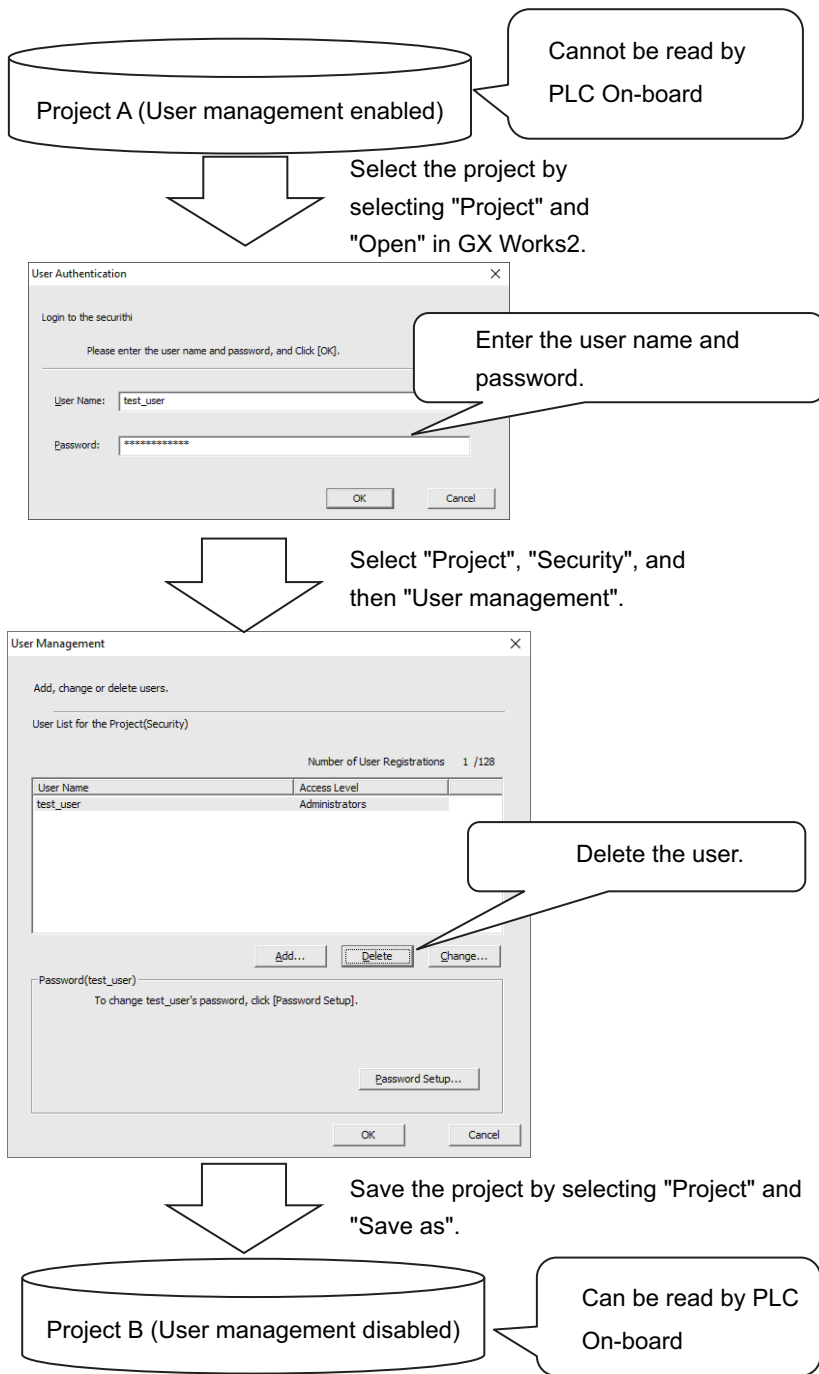

If PLC data with the same name has already been read, the confirm overwrite popup screen is displayed.

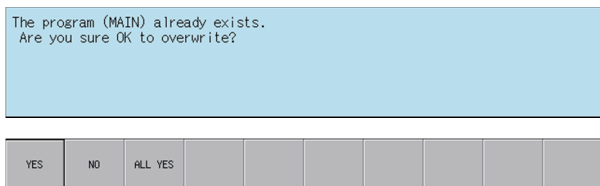

6 Explanation of Built-in Editing Function (PLC On-board)

6.14 External File Operation Menus

For GX Works2, if project data exists in CNC, the data replace confirm popup screen is displayed.

Program (symbolic information), or PLC parameter already exist.
Are you sure you want to replace all programs (symbolic information) and PLC parameters?

For GX Works2 simple project (with labels) or structured project, press the "Read" menu to clear the device value in a range set in the automatic device assignment setting to zero.

A progress bar is displayed indicating the status of reading and writing PLC data. (Refer to "6.14.10 Progress Screen" for display at GX Works2)

[GX Developer project]



(3) After the selected PLC data has been read and written, the complete message is displayed.

Completed.



If PLC data is written while the PLC is running, a message confirming whether or not to pause the PLC is displayed. Select [YES] to stop the PLC and continue writing the PLC data. If [NO] is selected, the PLC does not stop which results in an error and the display of an error message. (Refer to "Abnormal operation")

If the PLC stops, a message displays to confirm whether or not to restart the PLC immediately after data has been written. Select [YES] to continue running the PLC. Select [NO] to keep the PLC stopped.

PLC is in a RUN state.
Is read performed after stop PLC?



PLC is in a STOP state.
Is PLC changed into a RUN state?



When a device comment file with no data is selected, the file is not written and the following confirmation message is displayed.

There is no data in comment (COMMENT).
Data was not written.

6 Explanation of Built-in Editing Function (PLC On-board)

6.14 External File Operation Menus

Abnormal operation

This information describes the details of error messages displayed on the "EXT.->NC" screen and the corrective action thereof.

Error message	Error details	Remedy
Read data has not been selected.	This is displayed when the [EXECUTE] menu key is pressed before any PLC data has been selected from the displayed list.	Select PLC data from the list before pressing the [EXECUTE] menu key.
Write executions cannot be performed because the PLC is running. Execute again after the PLC stops.	This displays when attempting to store PLC data stored in an external device into the NC without stopping the PLC.	Store PLC data stored in an external device into the NC after stopping the PLC.
Device point that is set in parameter is not match the device point in NC. Continue the reading PLC or writing PLC?	This message appears when you attempt to read a parameter file that has a different number of device points from that of the NC for a project without labels. When you select [Yes], reading of the parameter file is skipped and the reading process is continued. When you select [No], the reading process is cancelled.	Before reading a parameter file, check the number of NC device points in "6.18.6 Device Settings Screen" and correct if unmatched.
There is a program which is not converted/compiled. Convert/compile the program before executing.	This message appears when uncompiled data exists in PLC data for a project with labels or a structured project.	Open a project with GX Works2, convert/compile it, and save it in external device. Then store PLC data stored in external device to CNC.
The device points set in the parameter do not match the device points in NC. The reading from PLC or writing to PLC is suspended.	This message appears when you attempt to read a parameter file that has a different number of device points from that of the CNC for a project with labels or a structured project.	Before reading a parameter file, check the number of device points of CNC in "6.18.6 Device Settings Screen" and correct if unmatched.
The project cannot be executed: user management setting is enabled in the security function. Disable the user management setting in GX Works2, then execute the project.	This is displayed if user management is set for GX Works2 project.	Open a project with GX Works2, delete a user, and save it in external device. Refer to security function in "6.14.2.6 Reading External Project Data and Storing in the NC" for details.
Reading out a project with labels created with GX Developer. This project is not supported, it will be read out as a project without labels.	This message is displayed when reading a project with labels created with GX Developer.	This does not effect operation of PLC on-board. (Operates as a project without labels.) Note that when editing with PLC on-board, symbolic information of a project with labels may differ.
The project cannot be read out: the PLC type of which NC does not support is set.	This message is displayed when PC type unsupported by CNC (other than Q26UDH) is set on GX Works2.	Set a project setting to CNC PC type in [Project] - [Change PLC type] with GX Works2, then store the project to external device. Then store PLC data stored in external device to CNC.
Failed to write to the NC. The project data in the NC has been deleted. Fix the following and try again: ♦ A ladder instruction not specified by this product is included. ♦ The memory capacity is insufficient.	This message is displayed when writing to a CNC fails.	Please execute EXT. -> NC function again after checking the following problems. ♦ - A ladder instruction not specified by this product is included. ♦ - File capacity exceeds the upper limit. ♦ - Remote password is contained in a project.

6.14.2.7 Closing the "EXT.->NC" Screen

Use any of the following methods to close the "EXT.->NC" screen.

Methods to close the screen
Press the [CLOSE] menu key.
Press the left arrow key.
Press the [ESC] key on the software keyboard.

6.14.3 Select External Project Popup Screen

6.14.3.1 Outline

This displays a list of project data stored in external devices and selects the project data to be read. Projects that match the project operation mode are listed. For operation mode, refer to "6.1.3 Operation Mode of Project". Only projects with one file format can be listed and selected for GX Works2 projects.

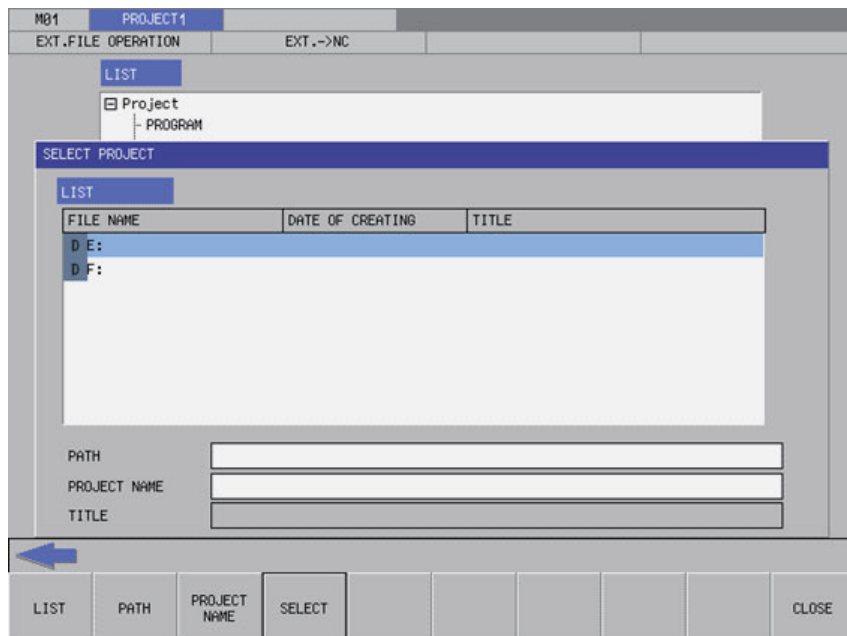

6.14.3.2 Screen Display Items

The following table describes the screen display items for the select external project popup screen.

Item name	Display state
List	This displays the directory and PLC data stored at the specified path.
Path	This displays the path where the project data is stored. (the path can be entered)
Project name	This displays the name of the project data selected in the list. (the project name can be entered)
Title	This displays the title set in the project data selected in the list.

6.14.3.3 Enabled/Disabled State of Menu Keys

The following table describes the conditions upon which menu keys displayed on the select external project popup screen are enabled/disabled.

The menu keys which are not described in the following table are always enabled.

Menu name	Condition upon which it is enabled/disabled
Select	Enabled when the path and project name are not blank

6.14.3.4 Status during Screen Displays

The following table describes the status when displaying the select external project popup screen.

Item name	Operation
List	Refer to "6.14.3.5 Displaying PLC Data".
Path	This is blank or displays the path that is displayed in the List.
Project name	This is blank or displays the project data that is selected in the list.
Title	This is blank or displays the title specified in the project data that is selected in the list. The title is not displayed when displaying the list of GX Works2 project.

6.14.3.5 Displaying PLC Data

This displays the directory and project data stored directly under the root path of the default external device when the select external project popup screen is displayed for the first time.

This displays the details of the path where the previously selected project is stored when the select external project popup screen is displayed after a project is already selected. This displays path details directly under the root of the default external device when there is no specified path.

[List for the initial display of the screen]

FILE NAME	DATE OF CREATING	TITLE
D ..		Upper rank directory
P LADDER	2014/12/25 17:33:40	LADDER PROGRAM
D OTHER		Directory
P PROJECT	2014/12/25 17:34:49	PROJECT1



[List display when a project is selected]

FILE NAME	DATE OF CREATING	TITLE
D ..		Upper rank directory
P BASE	2015/01/05 11:43:44	



[List to be displayed next time]

FILE NAME	DATE OF CREATING	TITLE
D ..		Upper rank directory
P BASE	2015/01/05 11:43:44	

6.14.3.6 Operation of Key Presses

The following table describes the operation of each menu key and the keys on the NC keyboard when pressed.

Item name	Operation
Left arrow key	Refer to "6.14.3.8 Closing the Select External Project Popup Screen".
List	This selects the list.
Path	This selects the password input field.
Project name	This selects the project name input field.
Select	Refer to "6.14.3.7 Select External Projects".
Close	Refer to "6.14.3.8 Closing the Select External Project Popup Screen".

6.14.3.7 Select External Projects

Normal operation

■ To directly input the path and project name

- (1) Press the [PATH] menu key to move the focus to the path input field. Input the path where the project data is stored.
This operation is not necessary if the read source does not need to be changed.
- (2) Press the [PROJECT NAME] menu key to move the focus to the project name input field. Enter the name for the project data.
- (3) Pressing the [SELECT] menu key closes the select external project popup screen and returns to the "EXT.->NC" screen.
The PLC data stored in the selected project is displayed in the list on the "EXT.->NC" screen.

When operation mode of a project is GX Works2, if the project and folder have the same name as the input name, the project is selected first.

Only a project with one file format can be read for GX Works2 project.

■ To select a project from the list

- (1) Press the [LIST] menu key to move the focus to the list. Use the up and down arrow keys to select existing project data.
- (2) Pressing the [INPUT] menu key or pressing the [SELECT] menu key closes the select external project popup screen and returns to the "EXT.->NC" screen. The PLC data stored in the selected project is displayed in the list on the "EXT.->NC" screen.

Only a project with one file format can be read for GX Works2 project.

[List for the select external project screen]

FILE NAME	DATE OF CREATING	TITLE
D ..		Upper rank directory
P LADDER	2014/12/25 17:33:40	LADDER PROGRAM
D OTHER		Directory
P PROJECT	2014/12/25 17:34:49	PROJECT1

Select the project data.



[List for the "EXT.->NC" screen]

PROJECT1

- PROGRAM
 - M1MSG MESSAGE 1
 - M2MSG MESSAGE 2
 - MAIN
- DEVICE COMMENT
 - CMNT ADDITIONAL COMMENT
 - COMMENT
- Parameter
 - PLC/Network

Display the PLC data stored in the selected project.

Abnormal operation

This information describes the details of error messages displayed on the select project popup screen and the corrective action thereof.

Error message	Error details	Remedy
The specified project does not exist. Specify an existing project path/project name.	This is displayed when the [SELECT] menu key is pressed after entering a path or project name that does not exist.	Enter the correct path and project name and then press the [SELECT] menu key again.

6.14.3.8 Closing the Select External Project Popup Screen

Use any of the following methods to close the select external project popup screen.

Methods to close the screen
Select the project and then press the [SELECT] menu key.
Press the [CLOSE] menu key.
Press the left arrow key.
Press the [ESC] key on the software keyboard.

6.14.4 "NC" -> "EXT." Screen

6.14.4.1 Outline

This stores the PLC data stored in the operation target project in GX Developer or GX Works2 format to an external device.

■ "NC" -> "EXT." screen display with GX Developer format

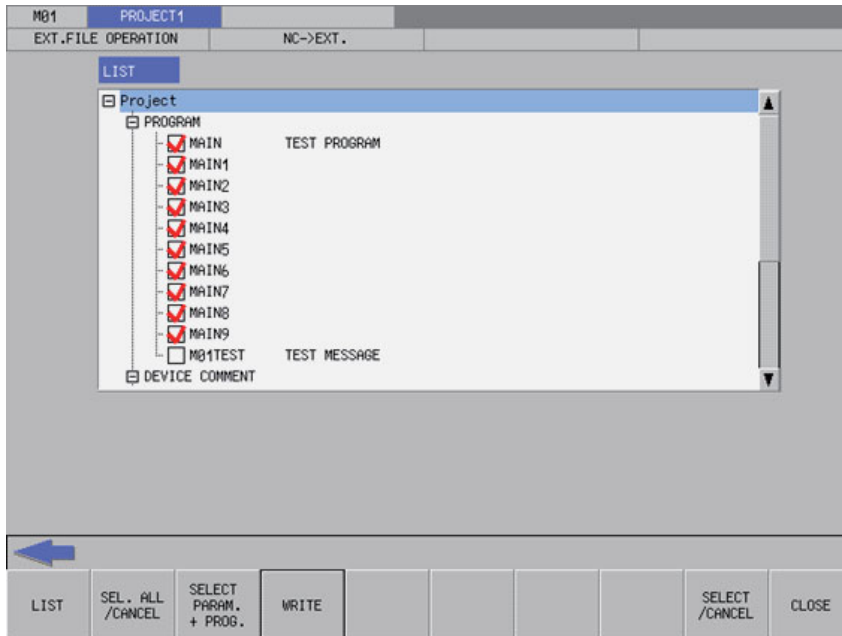

■ "NC" -> "EXT." screen display with GX Works2 format (a project with labels or a structured project)

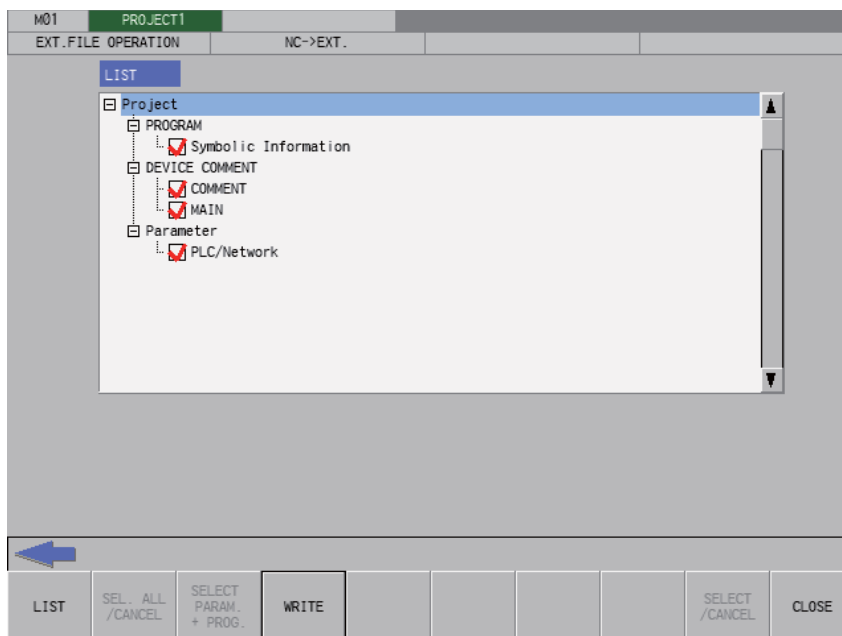

Screen display is the same as GX Developer for a GX Works2 project without labels.

6.14.4.2 Screen Display Items

The following table describes the screen display items for the "NC->EXT." screen.

Item name	Display state
Connected NC name	This displays the name of the connected NC.
Current project No.	This displays the current project number.
Current project label	This displays the project label.
Alarm message	Alarm messages are displayed when alarms occur.
Left arrow key	This is displayed when enabled.
Software keyboard	This is displayed only when parameters are enabled.
List	This displays the PLC data stored in the current project. This displays nothing if there is nothing stored.

6.14.4.3 Enabled/Disabled State of Menu Keys

The following table describes the conditions upon which menu keys displayed on the "NC->EXT." screen are enabled/disabled.

The menu keys which are not described in the following table are always enabled.

Menu name	Condition upon which it is enabled/disabled
Select/cancel all data	Enabled when selectable PLC data has been added to the list Disabled when storing a GX Works2 project because all data is always selected.
Parameter + Program	Enabled when selectable PLC data has been added to the list Disabled when storing a GX Works2 project because all data is always selected.
Select/cancel data	Enabled when selectable PLC data has been added to the list Disabled when storing a GX Works2 project because all data is always selected.

6.14.4.4 Status during Screen Displays

The following table describes the status when displaying the "NC->EXT." screen.

Item name	Operation
List	This is the default focus position when the screen is displayed. This displays the PLC data stored in the current project.

6.14.4.5 Operation of Key Presses

The following table describes the operation of each menu key and the keys on the NC keyboard when pressed.

Item name	Operation
Left arrow key	Refer to "6.14.4.7 Closing the "NC" -> "EXT." Screen".
List	The focus is applied to the list.
Select/cancel all data	This selects/deselects the check boxes for all data in the list.
Parameter + Program	This selects/deselects the check boxes for parameters and programs in the list. This does not include PLC messages however.
Write	Refer to "6.14.4.6 Storing PLC Data Stored in the Current Project into an External Device".
Select/cancel all data	This selects/deselects the check boxes for data selected in the list. This operation can also be performed with the [SP (space)] key.
Close	Refer to "6.14.4.7 Closing the "NC" -> "EXT." Screen".

6.14.4.6 Storing PLC Data Stored in the Current Project into an External Device

Normal operation

- Press the [LIST] menu key to move the focus to the list. Select the desired PLC data from the list. Deselect the check boxes for data you do not want to store.
PLC data cannot be selected for GX Works2 project because all the PLC data is stored in a batch. The check box is always selected.
- After selecting data, press the [WRITE] menu key. After pressing this menu key, the save external project popup screen displays.
- On "SAVE EXTERNAL PROJECT" popup screen, specify the destination project and then press the [SELECT] menu key. The PLC data selected in the list on the "NC->EXT." screen is saved to the project specified on the [SAVE EXTERNAL PROJECT] popup screen.
After the save process completes, the save external project popup screen closes.
Refer to "6.14.5 Save External Project Popup Screen" for more information on the process performed with the save external project popup screen.
GX Works2 project is saved in one file format.
Depending on operation mode, handling of PLC data in external device differ when operating external file. Refer to "6.6.2.3 Handling of PLC Data during External File Operation" for details.

6 Explanation of Built-in Editing Function (PLC On-board)

6.14 External File Operation Menus

If a password to protect reads/writes has been registered to the selected files, the cancel password screen is displayed.
 Enter the password to temporarily cancel the password.
 If the password is temporarily cancelled, processing will continue.
 Refer to "6.21 Canceling File Passwords" for information on entering and clearing passwords.

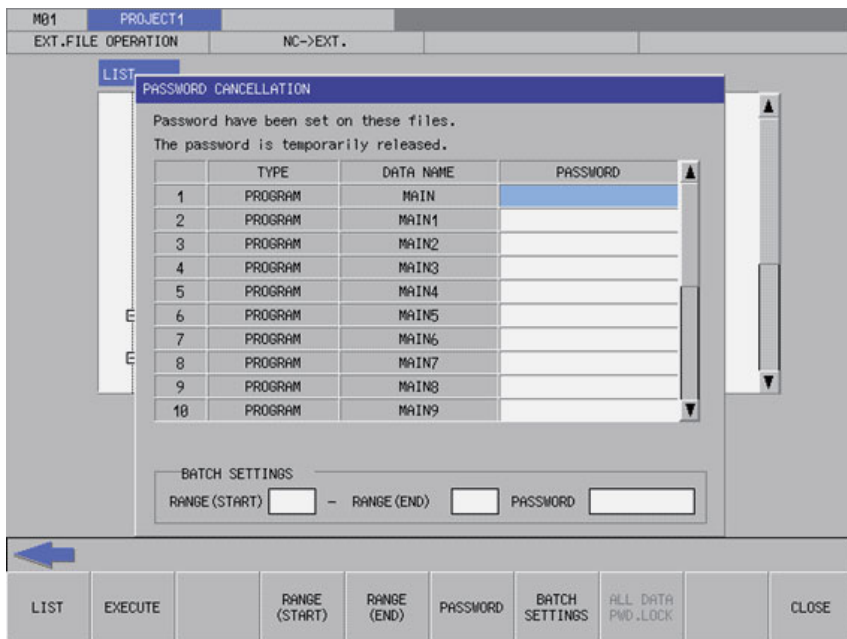

Note

- (1) When a project with labels or a structured project is stored in CNC, data is stored to external device in symbolic information units. All the programs contained in symbolic information are stored in external device. Programs cannot be stored in program file units.

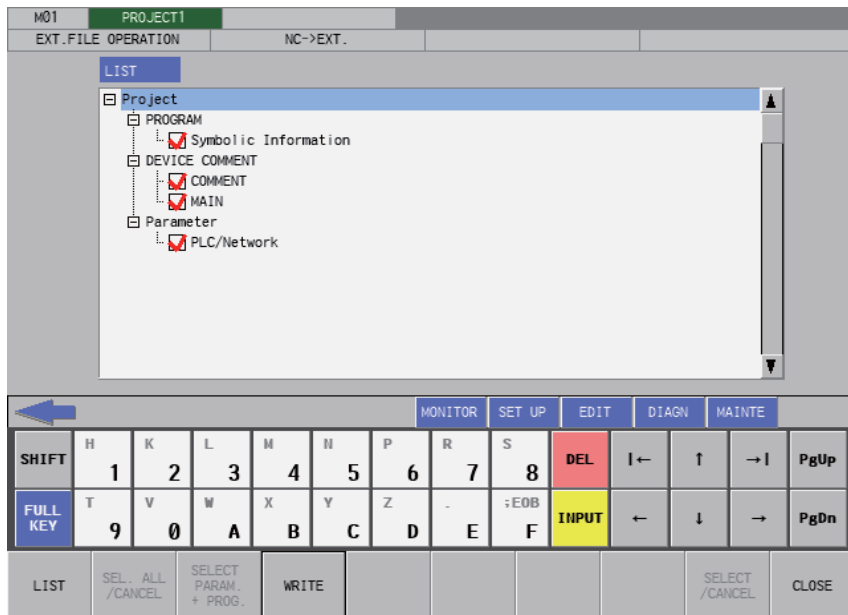

Temporarily disable the password of all program files with password registered if program files in symbolic information have password that cannot be read/written. Temporarily cancel the password to store a program file to external device.
 Refer to "6.21 Canceling File Passwords" for information on clearing the passwords.

Abnormal operation

This information describes the details of error messages displayed on the "NC->EXT." screen and the corrective action thereof.

Error message	Error details	Remedy
Write data has not been selected.	This is displayed when you press the [EXECUTE] menu key without selecting any PLC data from the list.	Select PLC data from the list before pressing the [EXECUTE] menu key.
It is not possible to add more programs than this to the current project. Delete any unnecessary programs and try again.	This is displayed when the total number of the selected programs and PLC messages exceeds the upper limit of 124.	Select the programs and PLC messages so that the total number of them is 124 or less before pressing the [EXECUTE] menu key.
The project cannot be read out: the project with labels created with GX Developer was attempted to be read out while "operation mode" on the PLC on-board is set to GX Works2.	This message is displayed when executing "NC -> EXT." to a project with labels created with GX Developer when operation mode of PLC on-board is GX Works2.	Change the operation mode of a project to GX Developer, then restart PLC on-board. For setting method of operation mode refer to "6.1.3 Operation Mode of Project".
The project is created as "project with labels" or "structured project", however, the symbolic information is not stored. If the project is edited, it may lead to loss of the consistency with the symbolic information.	This message is displayed when executing "NC -> EXT." to a project with labels or a structured project while symbolic information is not stored in CNC when operation mode of PLC on-board is GX Works2.	Saved as GX Works2 project without labels. Store symbolic information to save as the original project type.

6.14.4.7 Closing the "NC" -> "EXT." Screen

Use any of the following methods to close the "NC->EXT." screen.

Methods to close the screen
Press the [CLOSE] menu key.
Press the left arrow key.
Press the [ESC] key on the software keyboard.

6.14.5 Save External Project Popup Screen

6.14.5.1 Outline

This displays a list of project data stored in external devices, selects the project data to be saved, and also creates new data. Projects that match the project operation mode are listed. For operation mode, refer to "6.1.3 Operation Mode of Project". Only projects with one file format can be listed and selected for GX Works2 projects.

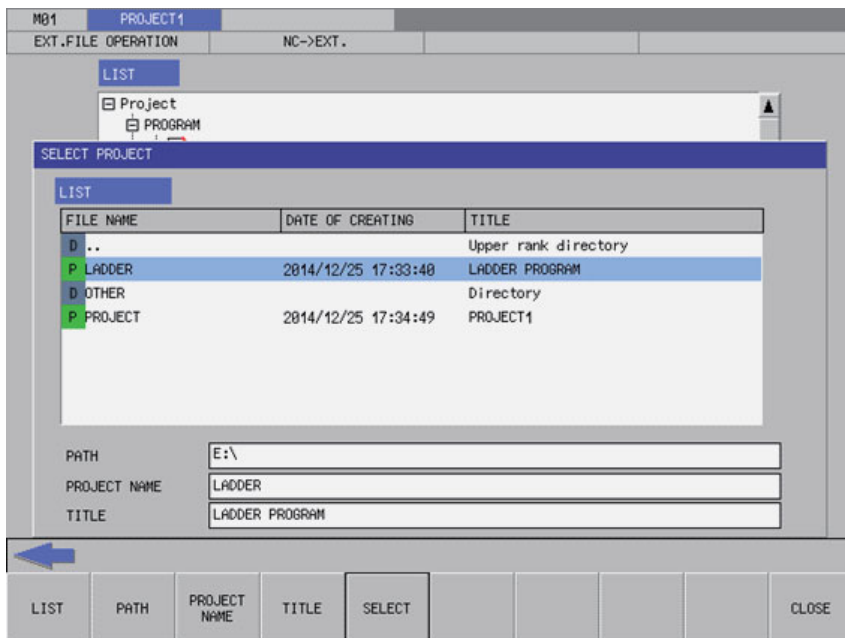

6.14.5.2 Screen Display Items

The following table describes the screen display items for the save external project popup screen.

Item name	Display state
List	This displays the directory and PLC data stored at the specified path.
Path	This displays the path where the project data is stored. (the path can be entered)
Project name	This displays the name of the project data selected in the list. (the project name can be entered)
Title	This displays the title set in the project data selected in the list. (the title can also be entered)

6.14.5.3 Enabled/Disabled State of Menu Keys

The menu key displayed on the save external project popup screen are always enabled.

6.14.5.4 Status during Screen Displays

The following table describes the status when displaying the save external project popup screen.

Item name	Operation
List	Refer to "6.14.5.5 Displaying PLC Data".
Path	This is blank or displays the path that is displayed in the List.
Project name	This is blank or displays the project data that is selected in the list.
Title	This is blank or displays the title specified in the project data that is selected in the list. The title is not displayed when displaying list of GX Works2 project.

6.14.5.5 Displaying PLC Data

This displays the directory and project data stored directly under the root path of the default external device when the save external project popup screen is displayed for the first time.

This displays the details of the path where the previously saved project is stored when the save external project popup screen is displayed after a project is already saved. This displays path details directly under the root of the default external device when there is no specified path.

[List for the initial display of the screen]

FILE NAME	DATE OF CREATING	TITLE
D ..		Upper rank directory
P LADDER	2014/12/25 17:33:40	LADDER PROGRAM
D OTHER		Directory
P PROJECT	2014/12/25 17:34:49	PROJECT1



[List display when a project is selected]

FILE NAME	DATE OF CREATING	TITLE
D ..		Upper rank directory
P BASE	2015/01/05 11:43:44	



[List to be displayed next time]

FILE NAME	DATE OF CREATING	TITLE
D ..		Upper rank directory
P BASE	2015/01/05 11:43:44	

6.14.5.6 Operation of Key Presses

The following table describes the operation of each menu key and the keys on the NC keyboard when pressed.

Item name	Operation
Left arrow key	Refer to "6.14.5.8 Closing the Save External Project Popup Screen".
List	This selects the list.
Path	This selects the password input field.
Project name	This selects the project name input field.
Title	This selects the title input field.
Select	Refer to "6.14.5.7 Saving to External Projects".
Close	Refer to "6.14.5.8 Closing the Save External Project Popup Screen".

6.14.5.7 Saving to External Projects

Normal operation

■ To save to new projects

- Press the [PATH] menu key to move the focus to the path input field. Enter the save destination for the project data. This operation is not necessary if the save destination does not need to be changed.
- Press the [PROJECT NAME] menu key to move the focus to the project name input field. Enter the name for the project data.
- Press the [TITLE] menu key to move the focus to the title input field. Enter the title for the project data. Titles are optional.
- Pressing the [SELECT] menu key creates the project data according to the specified name and tile at the specified path and then stores the PLC data selected at the "NC->EXT." screen.

When operation mode of a project is GX Works2, if the new project has the same name with the folder in the selected path, the project cannot be saved. Input a project name to display the file list in the folder of the same name.

When operation mode of a project is GX Works2, only projects in one file format can be listed and selected.

A progress bar is displayed indicating the status of writing PLC data. (Refer to "6.14.10 Progress Screen" for display at GX Works2)

[GX Developer project]



- After the selected PLC data has been written, the complete message is displayed. Pressing the [OK] menu key closes the complete message and also ends the save external project screen.



■ To save to existing projects

- (1) Press the [LIST] menu key to move the focus to the list. Use the up and down arrow keys to select existing project data.
- (2) Pressing the [INPUT] key or the [SELECT] menu key saves the PLC data selected at the "NC->EXT." screen to the selected project data.

When operation mode of a project is GX Works2, only projects in one file format can be listed and selected.

For GX Developer project, if PLC data with the same name exists, the overwrite confirm popup screen is displayed.

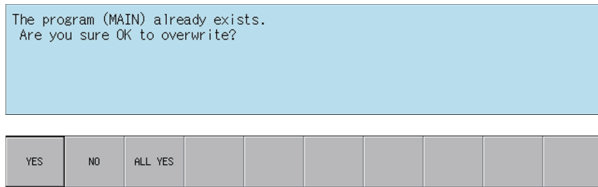

For GX Works2 project, since all the PLC data in external device is replaced, if a project with the same name exists, the popup screen to confirm project replacement is displayed.

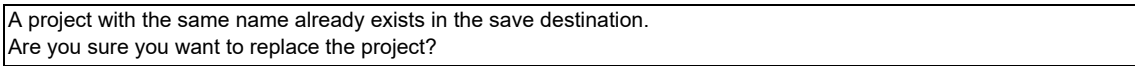

A progress bar is displayed indicating the status of writing PLC data. (Refer to "6.14.10 Progress Screen" for display at GX Works2)

[GX Developer project]



- (3) After the selected PLC data has been written, the complete message is displayed. Pressing the [OK] menu key closes the complete message and also ends the save external project screen.



Abnormal operation

This information describes the details of error messages displayed on the save external project popup screen and the corrective action thereof.

Error message	Error details	Remedy
This project/data name is a reserved device name. Please choose another name.	This is displayed after the [SELECT] menu key is pressed when a reserved device name (*1) has been entered as the data name.	Enter a suitable data name before pressing the [SELECT] menu key.
Prohibited characters were used in the file name. Do not use the following characters in file names: /, ;, ,, ;, *, ?, \, ", <, >,	This is displayed when the [SELECT] menu key is pressed and the data name contains prohibited characters (*1).	Enter a suitable data name before pressing the [SELECT] menu key.
File name includes the multi-byte character code. Please confirm file name.	This is displayed when the [SELECT] menu key is pressed and the data name contains double-byte characters.	Enter a suitable data name before pressing the [SELECT] menu key.
Illegal characters have been used for a data name. Use legal characters.	This is displayed when the [SELECT] menu key is pressed and the final character of the data name is a period.	Enter a suitable data name before pressing the [SELECT] menu key.

(*1) Refer to "6.6.1 PLC Data Used by the PLC On-board".

6.14.5.8 Closing the Save External Project Popup Screen

Use any of the following methods to close the save external project popup screen.

Methods to close the screen
Save the project data to the external device.
Press the [CLOSE] menu key.
Press the left arrow key.
Press the [ESC] key on the software keyboard.

6.14.6 Delete External File Popup Screen

6.14.6.1 Outline

This displays a list of project data stored in external devices and deletes the specified project data.

When operation mode of a project is GX Works2, "Delete External File Popup Screen" cannot be displayed and files cannot be deleted. For details on the operation mode, refer to "6.1.3 Operation Mode of Project".

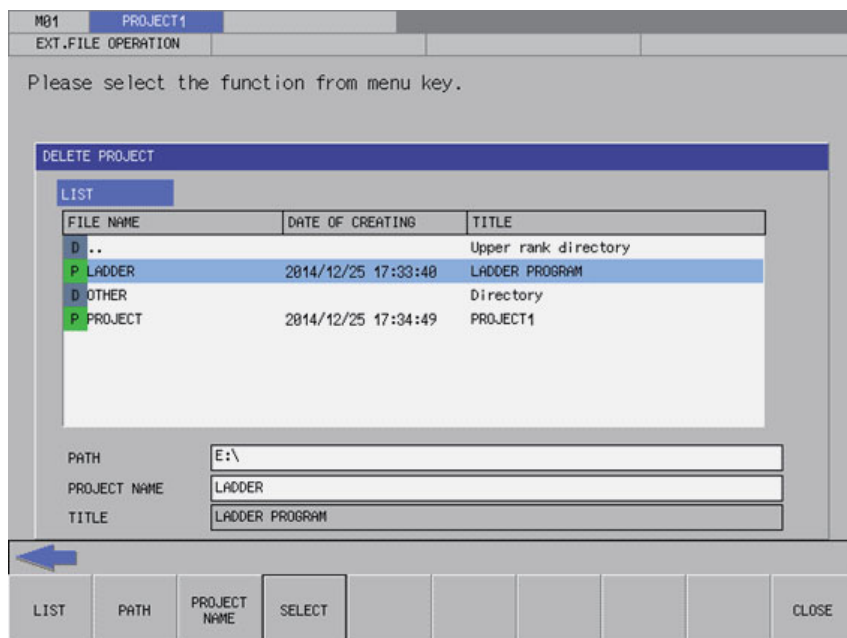

6.14.6.2 Screen Display Items

The following table describes the screen display items for the delete external file popup screen.

Item name	Display state
List	This displays the directory and PLC data stored at the specified path.
Path	This displays the path where the project data is stored. (the path can be entered)
Project name	This displays the name of the project data selected in the list. (the project name can be entered)
Title	This displays the title set in the project data selected in the list.

6.14.6.3 Enabled/Disabled State of Menu Keys

The menu keys displayed on the delete external project popup screen are always enabled.

6.14.6.4 Status during Screen Displays

The following table describes the status when displaying the delete external file popup screen.

Item name	Operation
List	Refer to "6.14.6.5 Displaying PLC Data".
Path	This is blank or displays the path that is displayed in the List.
Project name	This is blank or displays the project data that is selected in the list.
Title	This is blank or displays the title specified in the project data that is selected in the list.

6.14.6.5 Displaying PLC Data

This displays the directory and project data stored directly under the root path of the default external device when the delete external file popup screen is displayed for the first time.

This displays the details of the path where the previously selected project is stored when the delete external file popup screen is displayed after a project is already selected. This displays path details directly under the root of the default external device when there is no specified path.

[List for the initial display of the screen]

FILE NAME	DATE OF CREATING	TITLE
D ..		Upper rank directory
P LADDER	2014/12/25 17:33:40	LADDER PROGRAM
D OTHER		Directory
P PROJECT	2014/12/25 17:34:49	PROJECT1



[List display when a project is selected]

FILE NAME	DATE OF CREATING	TITLE
D ..		Upper rank directory
P BASE	2015/01/05 11:43:44	



[List to be displayed next time]

FILE NAME	DATE OF CREATING	TITLE
D ..		Upper rank directory
P BASE	2015/01/05 11:43:44	

6.14.6.6 Operation of Key Presses

The following table describes the operation of each menu key and the keys on the NC keyboard when pressed.

Item name	Operation
Left arrow key	Refer to "6.14.6.8 Closing the Delete External File Popup Screen".
List	This selects the list.
Path	This selects the password input field.
Project name	This selects the project name input field.
Select	Refer to "6.14.6.7 Deleting External Projects".
Close	Refer to "6.14.6.8 Closing the Delete External File Popup Screen".

6.14.6.7 Deleting External Projects

Normal operation

■ To directly input the path and name of the project to delete

- (1) Press the [PATH] menu key to move the focus to the path input field. Input the path where the project data is stored.
 (*) This operation is not necessary if the read source does not need to be changed.
- (2) Press the [PROJECT NAME] menu key to move the focus to the project name input field. Enter the name for the project data.
- (3) Press the [SELECT] menu key to display the confirm delete message. If [YES] is selected, the confirm delete message and the delete external file popup screen closes and the data is deleted. If [NO] is selected, the confirm delete message closes and then the system returns to the delete external file popup screen.

Delete the specified project.
 Are you sure you want to delete the entire contents of the specified project?

YES	NO								
-----	----	--	--	--	--	--	--	--	--

■ To select a project to delete from the list

- (1) Press the [LIST] menu key to move the focus to the list. Use the up and down arrow keys to select existing project data.
- (2) Press the [INPUT] menu key or the [SELECT] menu key to display the confirm delete message. If [YES] is selected, the confirm delete message and the delete external file popup screen closes and the data is deleted. If [NO] is selected, the confirm delete message closes and then the system returns to the delete external file popup screen.

Delete the specified project.
Are you sure you want to delete the entire contents of the specified project?

YES	NO								
-----	----	--	--	--	--	--	--	--	--

Abnormal operation

This information describes the details of error messages displayed on the delete external project popup screen and the corrective action thereof.

Error message	Error details	Remedy
The specified project does not exist. Specify an existing project path/project name.	This is displayed when the [SELECT] menu key is pressed after entering a path or project name that does not exist.	Enter the correct path and project name and then press the [SELECT] menu key again.

6.14.6.8 Closing the Delete External File Popup Screen

Use any of the following methods to close the delete external file popup screen.

Methods to close the screen
Delete the external files.
Press the [CLOSE] menu key.
Press the left arrow key.
Press the [ESC] key on the software keyboard.

6.14.7 Verify External File Screen

6.14.7.1 Outline

This compares the PLC data (sequence programs and parameters) stored in external devices with PLC data (sequence programs and parameters) stored in projects.

When operation mode of a project is GX Works2, "Verify External File Screen" cannot be displayed and files cannot be verified. For details on the operation mode, refer to "6.1.3 Operation Mode of Project".

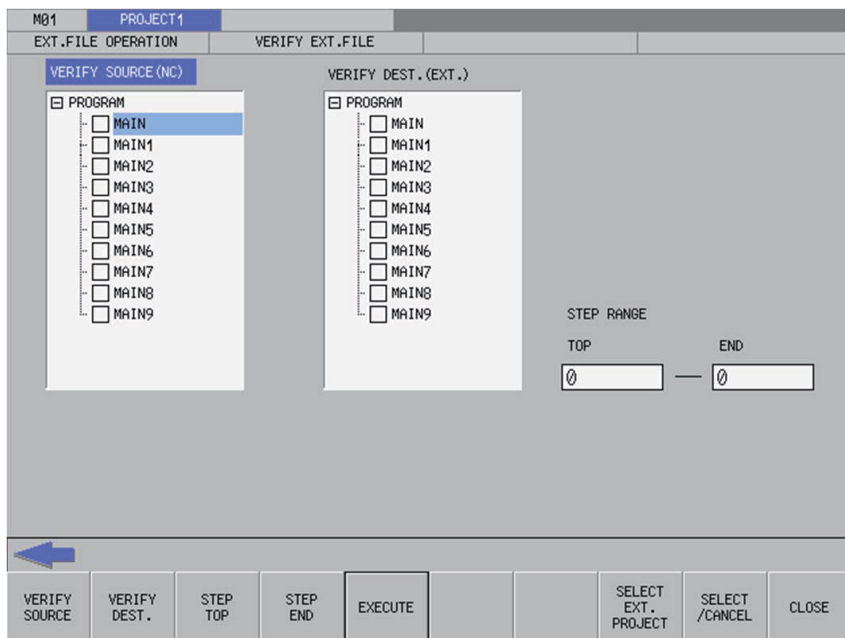

6.14.7.2 Screen Display Items

The following table describes the screen display items for the verify external file screen.

Item name	Display state
Connected NC name	This displays the name of the connected NC.
Current project No.	This displays the current project number.
Current project label	This displays the project label.
Alarm message	Alarm messages are displayed when alarms occur.
Left arrow key	This is displayed when enabled.
Software keyboard	This is displayed only when parameters are enabled.
Verify source (NC)	This displays the PLC data stored in the current project. This displays nothing if there is nothing stored.
Verify destination (external)	This displays PLC data stored in the selected on the select external project screen. This displays nothing if there is nothing stored or no PLC data has been selected.
Top of step range	This displays the top step number in the step range. A zero is displayed if there is nothing stored.
End of step range	This displays the end step number in the step range. A zero is displayed if there is nothing stored.

6.14.7.3 Enabled/Disabled State of Menu Keys

The following table describes the conditions upon which menu keys displayed on the verify external file screen are enabled/disabled.

The menu keys which are not described in the following table are always enabled.

Menu name	Condition upon which it is enabled/disabled
Select/cancel data	Enabled when selectable PLC data has been added to the list

6.14.7.4 Status during Screen Displays

The following table describes the status when displaying the verify external file screen.

Item name	Operation
Verify source (NC)	This displays the PLC data stored in the current project. This displays nothing if there is nothing stored.
Verify destination (external)	This displays PLC data stored in the selected on the select external project screen. This displays nothing if there is nothing stored or no PLC data has been selected.
Top of step range	This displays the top step number in the step range. A zero is displayed if there is nothing stored.
End of step range	This displays the end step number in the step range. A zero is displayed if there is nothing stored.

6.14.7.5 Operation of Key Presses

The following table describes the operation of each menu key and the keys on the NC keyboard when pressed.

Item name	Operation
Left arrow key	Refer to "6.14.7.7 Closing the Verify External File Screen".
Verify source	This sets the focus to verify source (NC) data.
Verify destination	This sets the focus to verify destination (external) data.
Top step	This sets the focus to the top of the step range.
End step	This sets the focus to the end of the step range.
Execute	Refer to "6.14.7.6 Verifying PLC Data".
Select external project	This displays the select external project popup screen. Refer to "6.14.3 Select External Project Popup Screen".
Select/cancel data	This selects/deselects the check boxes for data selected in the list that is highlighted, which is either the verify source (NC) data or the verify destination (external) data. This operation can also be performed with the [SP (space)] key.
Close	Refer to "6.14.7.7 Closing the Verify External File Screen".

6.14.7.6 Verifying PLC Data

Normal operation

- (1) Press the [VERIFY SOURCE] menu key to move the focus to the verify source (NC) data. Use the up and down arrow keys to select PLC data to verify. Use the [SELECT/DELETE DATA] menu key or the SP key to select the check boxes for the desired PLC data.
- (2) Press the [SELECT EXTERNAL PROJECT] menu key to display the select external project popup screen. Select the project data to verify in the select external project popup screen.
 - (*) Refer to "6.14.3 Select External Project Popup Screen" for more information on operations within the select external project popup screen.
- (3) Press the [VERIFY SOURCE] menu key to move the focus to the verify destination (external) data. Use the up and down arrow keys to select the category of PLC data as selected for the verify source data. Use the [SELECT/DELETE DATA] menu key or the SP key to select the check boxes for the desired PLC data.
- (4) After selecting data, press the [EXECUTE] menu key. Pressing this menu key compares the verify source PLC data with the verify destination PLC data and then displays the verify results popup screen.
 - (*) Refer to "6.14.8 Verify Results Popup Screen" for more information on the operations within the verify results popup screen.

If a password to protect reads/writes has been registered to the selected files, the cancel password screen is displayed.

Enter the password to cancel the password.

If the password is canceled, processing will continue.

Refer to "6.21 Canceling File Passwords" for information on clearing passwords.



Abnormal operation

This information describes the details of error messages displayed on the verify external file screen and the corrective action thereof.

Error message	Error details	Remedy
Verify source PLC data is not selected. Select verify source PLC data and execute again.	This is displayed when the [EXECUTE] menu key is pressed before any PLC data has been selected from the displayed verify source data list.	Select PLC data from the displayed verify source data list before pressing the [EXECUTE] menu key.
Verify destination PLC data is not selected. Select verify source PLC data and execute again.	This is displayed when the [EXECUTE] menu key is pressed before any PLC data has been selected from the displayed verify destination data list.	Select PLC data from the displayed verify destination data list before pressing the [EXECUTE] menu key.
Different types of data are selected. Check the files and execute again.	This is displayed when the [EXECUTE] menu key is pressed when the types of PLC data selected for the verify source data list and the verify destination data list are different.	Select the same types of data from the verify source data list and the verify destination data list and then press the [EXECUTE] menu key again.

6.14.7.7 Closing the Verify External File Screen

Use any of the following methods to close the verify external file screen.

Methods to close the screen
Press the [CLOSE] menu key.
Press the left arrow key.
Press the [ESC] key on the software keyboard.

6.14.8 Verify Results Popup Screen

6.14.8.1 Outline

This displays the results of comparing the PLC data (sequence programs and parameters) stored in external devices with PLC data (sequence programs and parameters) stored in projects.

When operation mode of a project is GX Works2, "Verify Results Popup Screen" cannot be displayed. For details on the operation mode, refer to "6.1.3 Operation Mode of Project".

[Verify sequence program results popup screen]

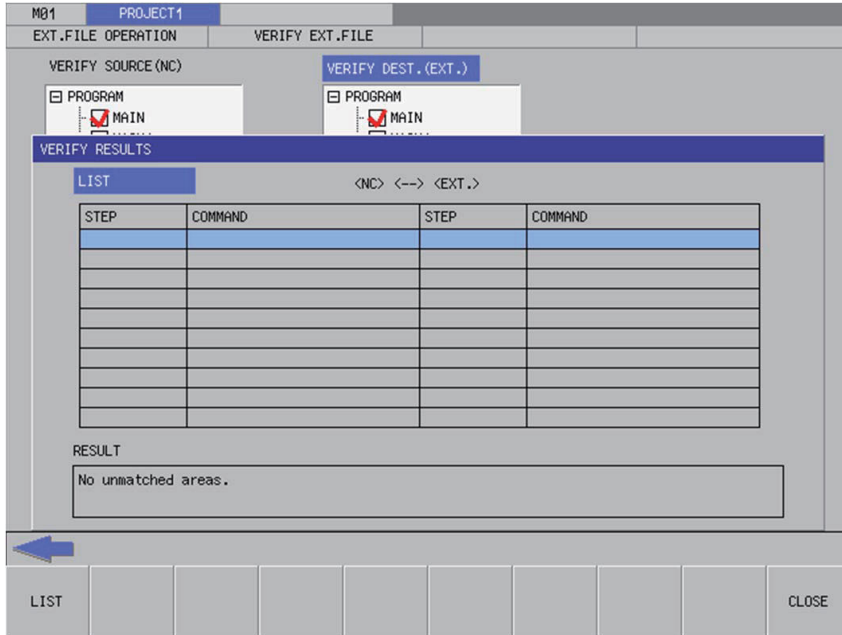

[Verify parameter results popup screen]

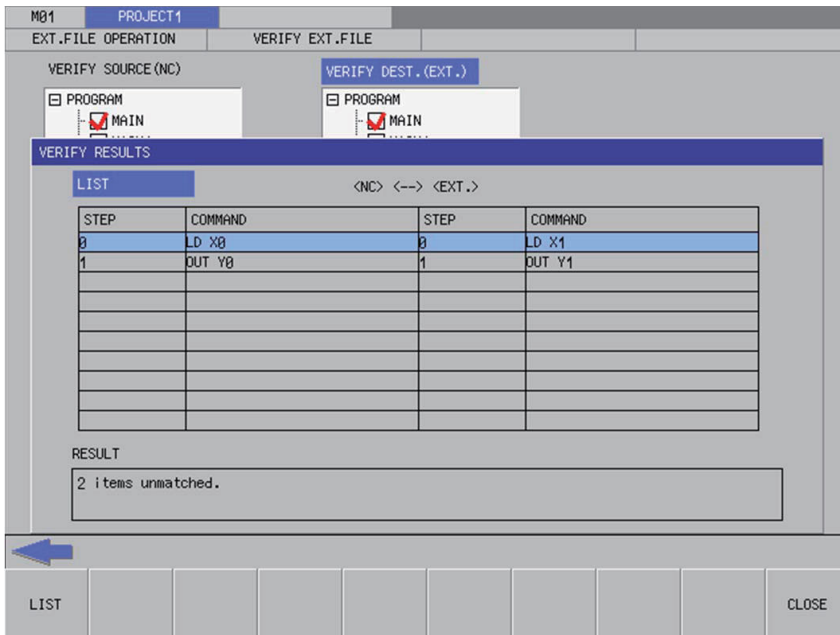

6.14.8.2 Screen Display Items

The following table describes the screen display items for the verify results popup screen.

Item name	Display state
Connected NC name	This displays the name of the connected NC.
Current project No.	This displays the current project number.
Current project label	This displays the project label.
Alarm message	Alarm messages are displayed when alarms occur.
Left arrow key	This is displayed when enabled.
Software keyboard	This is displayed only when parameters are enabled.
List	This displays the information that does not match. This is a blank display if there all data matches.
Result	This displays the verification result.

6.14.8.3 Enabled/Disabled State of Menu Keys

The menu keys displayed on the verify results popup screen are always enabled.

6.14.8.4 Status during Screen Displays

The following table describes the status when displaying the verify results popup screen.

Item name	Operation
List	This displays the information that does not match. This is a blank display if there all data matches.

6.14.8.5 Operation of Key Presses

The following table describes the operation of each menu key and the keys on the NC keyboard when pressed.

Item name	Operation
Left arrow key	Refer to "6.14.8.6 Closing the Verify Results Popup Screen".
List	This is the default focus position when the screen is displayed. This displays the information that does not match.
Close	Refer to "6.14.8.6 Closing the Verify Results Popup Screen".

6.14.8.6 Closing the Verify Results Popup Screen

Use any of the following methods to close the verify results popup screen.

Methods to close the screen
Press the [CLOSE] menu key.
Press the left arrow key.
Press the [ESC] key on the software keyboard.

6.14.9 Cancel Password Popup Screen

6.14.9.1 Outline

Passwords registered to PLC data files stored in the NC can be temporarily canceled.

Cancel password popup

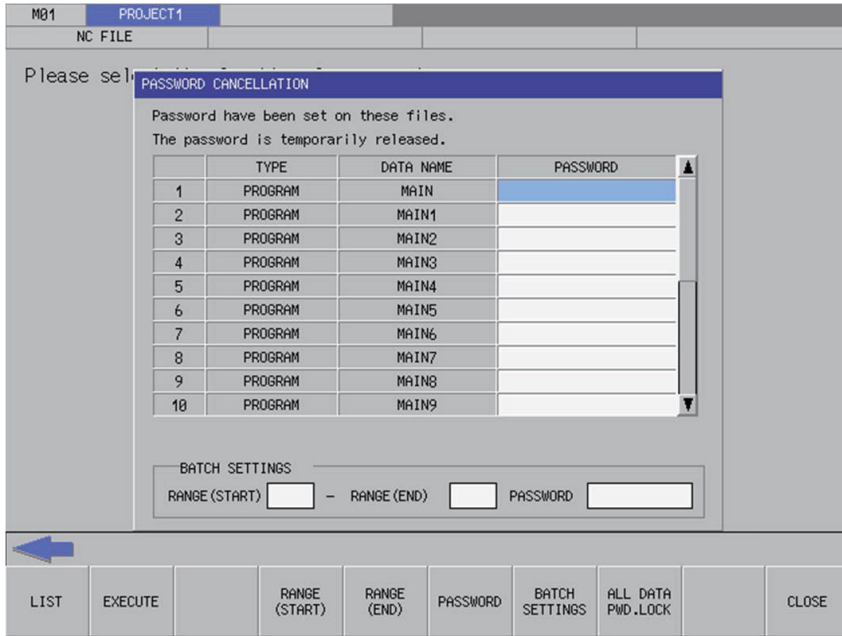

Refer to "6.13.11 Cancel Password Popup Screen" for details.

6.14.10 Progress Screen

Progress screen when reading/writing a project from/to CNC differs depending on operation mode.

The following progress screen is displayed for GX Works2 mode.

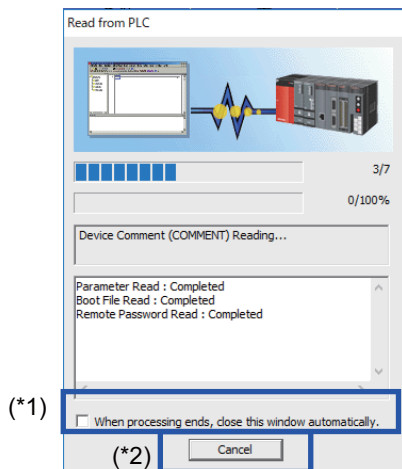

(*1) Regardless of the check box ON/OFF, progress screen closes automatically after processing ends.

(*2) When the [Cancel] button is pressed, processing stops after displaying a message.

When operating "EXT. -> NC", the following message is displayed when processing stops after project data in CNC is deleted.

Refer to "Abnormal operation" in "6.14.2.6 Reading External Project Data and Storing in the NC" for details of messages.)

Failed to write to the NC. The project data in the NC has been deleted. Fix the following and try again:

- A ladder instruction not specified by this product is included.
- The memory capacity is insufficient.

6.15 Ladder Menus

6.15.1 Ladder Monitor

6.15.1.1 Outline

The continuity state of contacts and coils can be monitored while displaying the PLC ladders.

When the program is created in a program language which cannot be displayed, it cannot be monitored.

Current value displayed on monitor may not be the current value at executing instruction.

[Ladder display and first page of the ladder monitor menu]

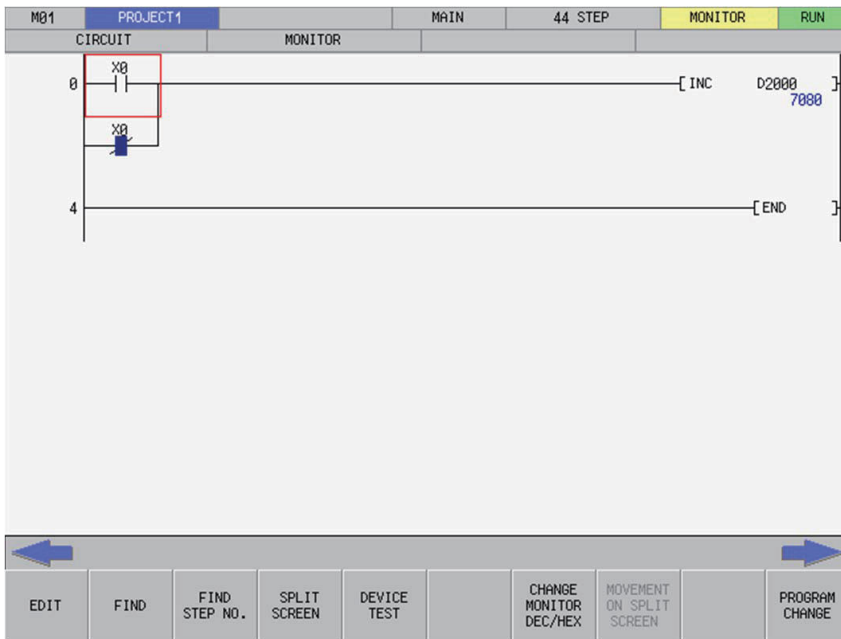

[Second page of the ladder monitor menu]



6.15.1.2 Screen Display Items

The following table describes the screen display items for the ladder monitor screen.

Item name	Display state
Connected NC name	This displays the name of the connected NC.
Current project No.	This displays the current project number.
Current project label	This displays the project label.
Program name	This displays the name of the currently displayed program.
Step number	Display differs depending on the operation mode. <ul style="list-style-type: none"> • GX Developer This displays the total number of file header capacity and program step number. • GX Works2 This displays the step number of a program.
Monitor/Edit display	This displays "MONITOR" or "MON. STOP(FB)". When transitioning to ladder in FB by searching, "MON. STOP(FB)" is displayed, and in other cases, "MONITOR" is displayed.
PLC status and overwrite/insert display	This displays the PLC state (RUN/STOP).
Alarm message	Alarm messages are displayed when alarms occur.
Left arrow key	This is displayed when enabled.
Right arrow key	This is displayed when enabled.
Software keyboard	This is displayed only when parameters are enabled.

6.15.1.3 Enabled/Disabled State of Menu Keys

The following table describes the conditions upon which menu keys displayed on the ladder monitor screen are enabled/disabled.

The menu keys which are not described in the following table are always enabled.

[First page of the ladder monitor menu]

Menu name	Condition upon which it is enabled/disabled
Edit	Enabled when not displaying PLC messages. Disabled when the function is restricted. Hidden when operation mode of the project is GX Works2.
Split screen	Hidden when operation mode of the project is GX Works2.
Transition to split screen	Enabled when using split screen mode
Device test	Disabled when transitioning to ladder in FB by searching.
Switching Programs	Enabled when using multiple programs

[Second page of the ladder edit menu]

Menu name	Condition upon which it is enabled/disabled
PLC RUN/STOP	Disabled when the function is restricted.
Zoom Display	Enabled when the screen resolution is 640x480
FB Instance Monitor	Hidden when operation mode of the project is GX Developer. Enabled when a project with labels or a structured project is read when operation mode of a project is GX Works2. Disabled when transitioning to ladder in FB by searching.
Contact coil usage list	Hidden when operation mode of the project is GX Works2.
List of used devices	Hidden when operation mode of the project is GX Works2.

6.15.1.4 Operation of Key Presses

The following table describes the operation of each menu key and the keys on the NC keyboard when pressed.

Item name	Operation
Left arrow key	This transitions to the main screen.
Right arrow key	First page of the menu: Transitions to the second page of the menu. Second page of the menu: Transitions to the first page of the menu.
EDIT	This transitions to the edit menu. This also stops the ladder monitor and changes to the edit ladder mode.
FIND	This displays the find popup screen.
FIND STEP NO.	This opens the Find Step No. popup screen.
SPLIT SCREEN	This transitions to the split screen menu.
DEVICE TEST	This displays the device test popup screen.
CHANGE MONITOR DEC/HEX	This changes the currently monitored value display between decimal and hexadecimal.
MOVEMENT ON SPLIT SCREEN	This moves the focus to the split screen when the split screen is displayed.
PROGRAM CHANGE	This displays the switch program screen.
CROSS REF. LIST	This opens the contact coil usage list popup screen.
LIST OF USED DEVCES	This opens the list of used devices popup screen.
COMMENT ON/OFF	This turns the device comment display on and off.
FB Instance Monitor	This displays the FB instance monitor. When the program is created in a program language which cannot be displayed, FB instance monitor screen is not displayed.
Zoom display	This switches the screen magnification of the ladder screen in this order: Reduced -> Standard -> Enlarged -> Reduced.
PLC RUN/STOP	Display the PLC RUN/STOP popup screen.

6.15.1.5 Ladder Display

Monitor display

During monitoring, the contact and coil ON/OFF state and the device's current value are displayed. These will change according to the PLC operation state.

The following diagram illustrates ladder ON/OFF state.

OFF:

ON:

For , only instructions with comparative instructions for the equivalent contact and bits for the equivalent coils are displayed.

The comparative instruction of a character string does not monitor the result.

The type of current value of devices (such as device range) differs depending on the calculation size of the instruction.

For character string, the current value is displayed with the start device as an integer value (16 bits). ((1) in figure)

(Example) When character string is "ABCD", "AB" is stored in start word device.

In this case, "AB" = "4241H" = "16961".

When the number of displayed characters of the current value is 10 or more, the font size is reduced. ((2) in figure)

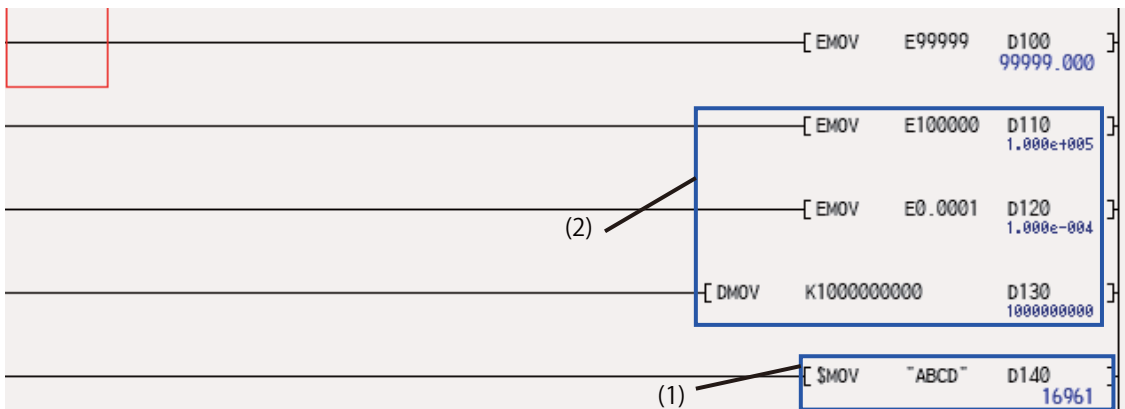

When the number of displayed characters is 10 or more, screen resolution is "VGA", and the display size is "REDUCE", "#####" is displayed.

Display size: Standard

Display size: Reduced

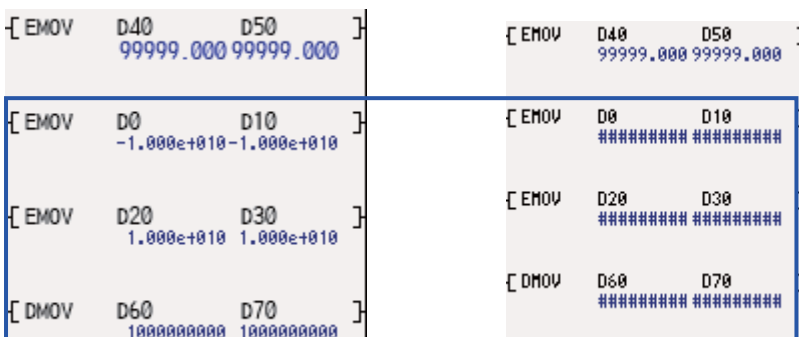

6 Explanation of Built-in Editing Function (PLC On-board)

6.15 Ladder Menus

When screen resolution is "VGA" and the display size is "REDUCE", if character constant, device comment, note, or statement is input with other than ASCII characters, it is replaced with "?".



Name and device ON/OFF state is displayed as follows when FB instance is displayed on ladder screen.



When transitioning to ladder in FB by searching, the program which uses the FB cannot be found and monitor is stopped. In this case, "MON. STOP(FB)" is displayed in the top-right of the screen.



Restrictions

The following restrictions apply to the ladder display on the ladder display screen.

- One ladder block must be created with 24 or less lines. An error will occur if there are more than 24 lines in one ladder block.
- The maximum number of contacts in one ladder line can be changed with the ladder display setting popup screen.
- The following table describes the number of characters displayed in comments.

Type	Number of characters displayed on ladder screen
Device comments	This is changed by the settings configured on the comment display setting screen.
Statements	All set characters are displayed.
Notes	
Aliases	

- Inline structured text box is not displayed.
- When FB is created in a programming language which cannot be displayed, FB instance monitor screen is not displayed. An error message "The FB is created in the programming language which cannot be displayed." is displayed.
- If label name is long, the following items are abbreviated ("...").

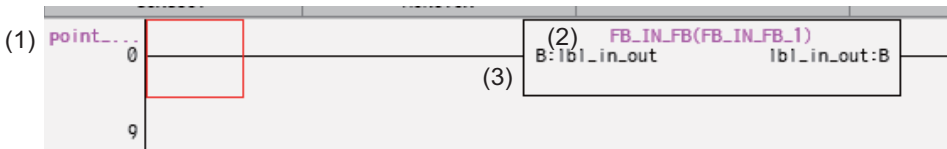

No	Item name	Number of displayed characters
(1)	Pointer labels	Up to 9 one-byte characters can be displayed. 10 or more characters are abbreviated.
(2)	FB name (FB name (FB Instance name))	Up to 34 one-byte characters can be displayed. FB instance name is displayed first. 35 or more characters are abbreviated.
(3)	Label used for inputting/outputting FB	Up to 15 one-byte characters can be displayed. 16 or more characters are abbreviated.

6 Explanation of Built-in Editing Function (PLC On-board)

6.15 Ladder Menus

To confirm the abbreviated label name, put the cursor on the target label and press the "INPUT" key, to display the find popup screen is displayed.

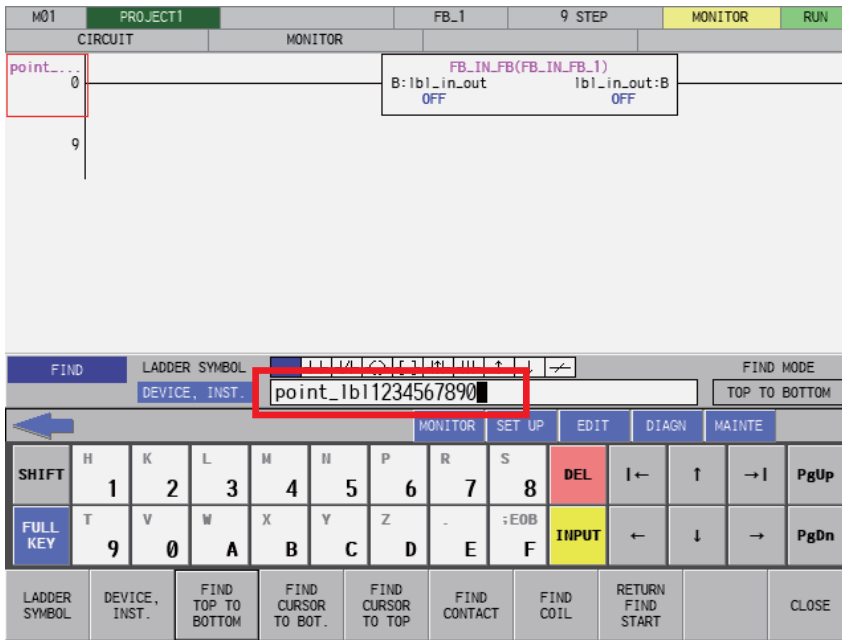

6.15.1.6 Moving the Cursor

To move the cursor displayed on the ladder screen, use the keys as described in "6.3 Operation Key List". The following table describes the cursor movement that occurs when each key is pressed.

Key	Operation
Up and down arrow keys	This moves the cursor on the ladder screen vertically for one increment.
Left and right arrow keys	This moves the cursor on the ladder screen horizontally in one increment.
→ key	This moves the cursor on the ladder screen forward (to the right) in increments of ladders. The cursor does not move in a horizontal line.
← key	This moves the cursor on the ladder screen backward (to the left) in increments of ladders. The cursor does not move in a horizontal line.
Page Up key	This moves the cursor on the ladder screen up one page.
Page Down key	This moves the cursor on the ladder screen down one page.

6.15.1.7 Starting and Stopping the Monitor

The following table describes the timings at which the monitor is started and stopped.

Start monitor	Stop monitor
Timing at which the PLC On-board starts and the ladder screen displays	Timing at which the system transitions to the edit menu
Timing at which the system transitions to the monitor menu	Timing at which the system transitions to the main menu
Timing at which the system transitions to the ladder screen	Timing at which the system transitions to a screen other than the ladder screen
	Timing at which the system transitions to the Mitsubishi Electric standard screen
	Timing at which the system transitions to the ladder in the FB by searching

6.15.2 Editing Ladders

6.15.2.1 Outline

This enables sequence programs, statements, and notes to be edited (overwrite, insert, and delete). Ladders cannot be edited when operation mode is GX Works2.

The following table describes which information displayable on the ladder screen can be edited.

	Editable
Sequence programs (ladder circuits)	○
PLC messages	×
Device comments	×
Statements	○
Notes	○
Aliases	×

[Ladder display and first page of the ladder edit menu]

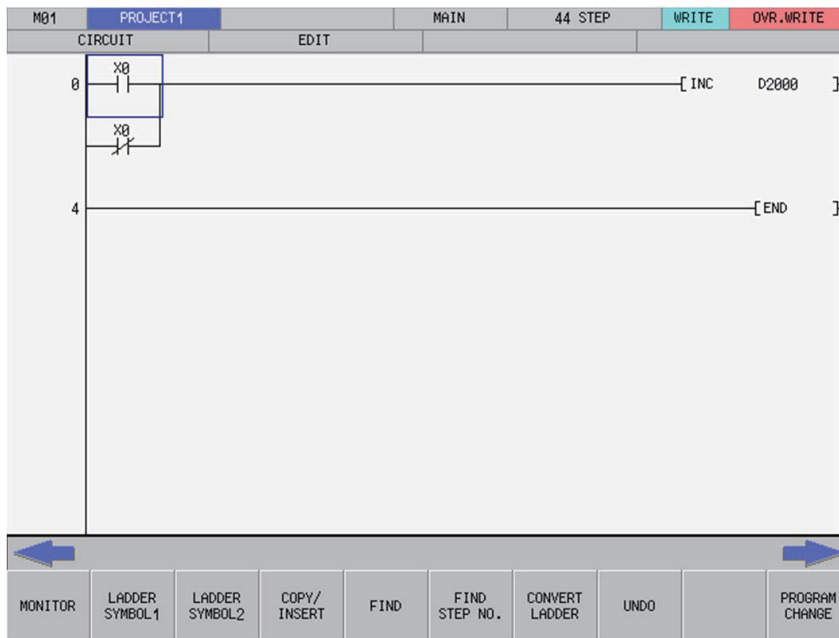

[Second page of the ladder edit menu]



6.15.2.2 Screen Display Items

The following table describes the screen display items for the ladder edit screen.

Item name	Display state
Connected NC name	This displays the name of the connected NC.
Current project No.	This displays the current project number.
Current project label	This displays the project label.
Program name	This displays the name of the currently displayed program.
Step number	This displays the step number of the currently displayed program.
Monitor/Edit display	This displays [EDIT].
PLC status and overwrite/insert display	This displays either [OVR. WRITE] or [INSERT] in correspondence with the edit mode.
Alarm message	Alarm messages are displayed when alarms occur.
Left arrow key	This is displayed when enabled.
Right arrow key	This is displayed when enabled.
Software keyboard	This is displayed only when parameters are enabled.

6.15.2.3 Enabled/Disabled State of Menu Keys

The following tables describe the conditions upon which menu keys displayed on the ladder edit screen are enabled/disabled.

The menu keys which are not described in the following table are always enabled.

[First page of the ladder edit menu]

Menu name	Condition upon which it is enabled/disabled
Convert Ladder	Enabled when there are unconverted ladders. Disabled when the function is restricted.
Undo	Enabled when there are unconverted ladders.
Switch Program	Enabled when using multiple programs.

[Second page of the ladder edit menu]

Menu name	Condition upon which it is enabled/disabled
Cancel edit ladder	Enabled when there are unconverted ladders.
Zoom display	Enabled when the screen resolution is 640 x 480.

6.15.2.4 Operation of Key Presses

The following table describes the operation of each menu key and the keys on the NC keyboard when pressed.

Item name	Operation
Left arrow key	This transitions to the main screen.
Right arrow key	First page of the menu: Transitions to the second page of the menu. Second page of the menu: Transitions to the first page of the menu.
Monitor	This transitions to the monitor menu. This also starts the ladder monitor.
Ladder Symbol 1	This transitions to the ladder symbol 1 menu.
Ladder Symbol 2	This transitions to the ladder symbol 2 menu.
Find	This displays the find popup screen.
Step No. search	This opens the Find Step No. popup screen.
Convert Ladder	This converts ladders not yet converted and edits details.
Undo	This returns to the unconverted ladder to the last previous state.
Switch Program	This displays the select program screen.
Contact Coil Usage List	This opens the contact coil usage list popup screen.
List of used devices	This opens the list of used devices popup screen.
Check Program	This opens the check program popup screen.
Comment ON/OFF	This turns the device comment display on and off.
Cancel edit ladder	This cancels the unconverted ladder and returns it to the state before any edits were made.
Zoom Display	This switches the screen magnification of the ladder screen in this order: Reduced -> Standard -> Enlarged -> Reduced.
Overwrite/Insert	This switches the edit mode between overwrite and insert mode.

6.15.2.5 Moving the Cursor

Refer to "6.15.1.6 Moving the Cursor".

6.15.2.6 Editing Ladders

Editing with instructions

Ladders can be edited using the following procedure.

- (1) Move to the edit position

Use the basic operation keys to move the cursor to the edit position. (Refer to "6.15.1.6 Moving the Cursor")

- (2) Display the enter symbol popup screen

Use the following procedure to display the enter symbol popup screen used to edit ladders.

- (a) To use the ladder symbol menu

Pressing the [LADDER SYMBOL 1] or the [LADDER SYMBOL 2] menu key on the first page of the ladder edit menu changes the menu keys as illustrated in the following diagram.

[LADDER SYMBOL 1 menu]



[LADDER SYMBOL 2 menu]



Pressing any of the menu keys in the area inside the red lines changes the display in accordance with the ladder symbol selected from the enter symbol popup screen.

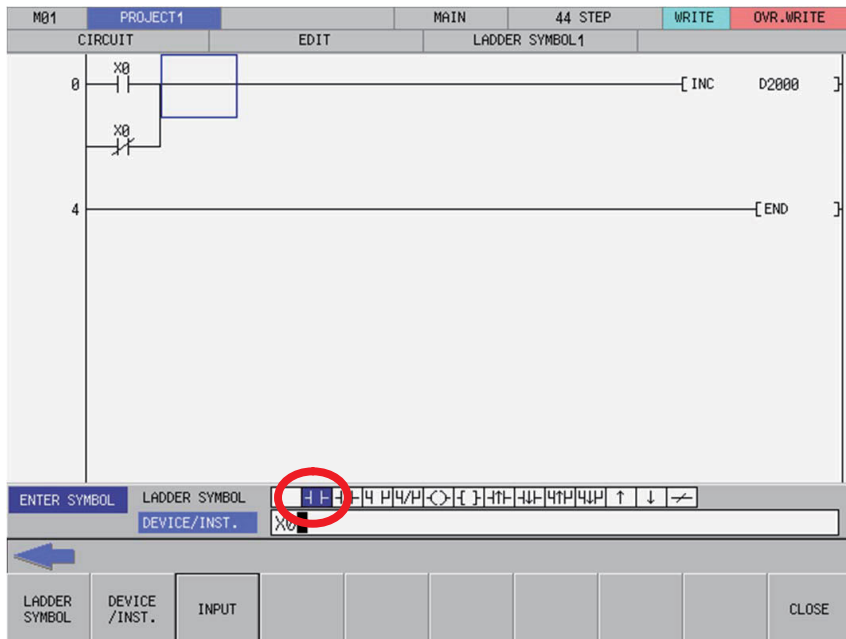

6 Explanation of Built-in Editing Function (PLC On-board)

6.15 Ladder Menus

(b) To use the INPUT key

Move the cursor to the ladder you want to edit on the ladder screen and press the [INPUT] key. The ladder symbol used for the ladder at the cursor position on the enter symbol popup screen is selected and the display changes in accordance with the instruction and device entered in the device/instruction field for the ladder at the cursor position.



(3) Ladder input patterns

(a) To use ladder symbols

The following information describes the basic input patterns when entering ladders to be edited on the enter symbol popup screen.

Instruction	Ladder symbol	Instruction
Connect instructions	- -	Device name (e.g. "X0")
Coil instructions	-< >-	Device name (e.g. "Y0")
Timer and counter coil instructions	-< >-	Device [SP] device (e.g. "T0 K10") (*1)
	-< >-	Device [SP] device [SP] (e.g. "H T0 K10") (*1)
Functions instructions	-[]-	Instruction [SP] device [SP] device (e.g. "MOV K0 R0") (*1)
Labels	(blank)	Device (e.g. "P4002")

(*1) [SP]: space code

(b) Enter symbols in list format

A list of instruction text strings can be directly entered and edited. (For most cases, enter the symbols using ladder symbols.)

The following information describes the input method using a contact instruction as an example.

Instruction	Ladder symbol	Instruction
Connect instructions	blank	Device name (e.g. "LD X0") (*1)

(*1) [SP]: space code

(4) Checking entered ladders

After entering the ladder symbols in accordance with the preceding input patterns, press the [INPUT] menu key. After pressing the input menu key, the enter symbol popup screen closes and the ladder edit screen is updated with the details of entry. The background color of entered ladder symbols updated on the ladder edit screen is changed to gray for each ladder block.

(5) Deleting circuits

Move the cursor to the ladder position to be edited and press the [DELETE] key to delete the ladder at that cursor position.

Inputting lines (vertical and horizontal)

(1) Move to the edit position

Use the basic operation keys to move the cursor to the edit position. (Refer to "6.15.1.6 Moving the Cursor".)

(2) Input lines

Pressing the [LADDER SYMBOL 1] or the menu key on the first page of the ladder edit menu changes the menu keys as illustrated in the following diagram.

[[LADDER SYMBOL 1] menu]



Pressing any of the menu keys in the area inside the red lines inputs a vertical or horizontal line as illustrated in the following diagrams.

♦ Vertical lines: A vertical line is input at the bottom-left of the cursor.



♦ Horizontal lines: A horizontal line is input at the cursor position.



(3) Deleting lines

(a) Deleting vertical lines

Move the cursor to the position such that the vertical line to be deleted is at the bottom-left of the cursor and then press the [DELETE] menu key in the [LADDER SYMBOL 2] menu keys.



Pressing the [DELETE] menu key deletes the vertical line at the position to the bottom-left of the cursor.



(b) Deleting horizontal lines

Move the cursor to the horizontal line position to be deleted and press the [DELETE] key to delete the horizontal line at the cursor position.

6 Explanation of Built-in Editing Function (PLC On-board)

6.15 Ladder Menus

Inserting lines

New lines can be inserted at the cursor position using the following procedure.

- (1) Move to the position where the line is to be inserted

Move the cursor to the position where the line is to be inserted using the basic operation keys. (Refer to "6.15.1.6 Moving the Cursor".)

- (2) Display the copy/insert menu.

Pressing the [COPY/INSERT] menu key on the first page of the ladder edit menu changes the menu keys as illustrated in the following diagram.

[[COPY/INSERT] menu]



- (3) Insert line menu key

Pressing the [INSERT LINE] menu key in the [COPY/INSERT] menu keys on the first page of the ladder edit menu inserts one blank line at the cursor position as illustrated in the following diagram.

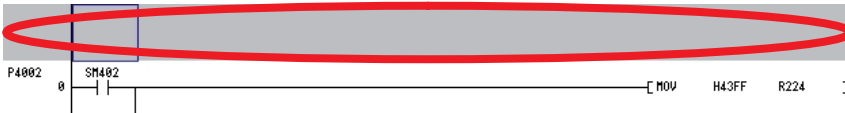

Deleting lines

Lines can be deleted at the cursor position using the following procedure.

- (1) Move to the position where the line is to be deleted

Move the cursor to the position where the line is to be deleted using the basic operation keys. (Refer to "6.15.1.6 Moving the Cursor".)

- (2) Display the copy/insert menu.

Pressing the [COPY/INSERT] menu key on the first page of the ladder edit menu changes the menu keys as illustrated in the following diagram.

[[COPY/INSERT] menu]



(3) Delete line menu key

Pressing the [DELETE LINE] in the [COPY/INSERT] menu keys on the first page of the ladder edit menu inserts one blank line at the cursor position as illustrated in the following diagram.

[Before deleting the line]



[After deleting the line]

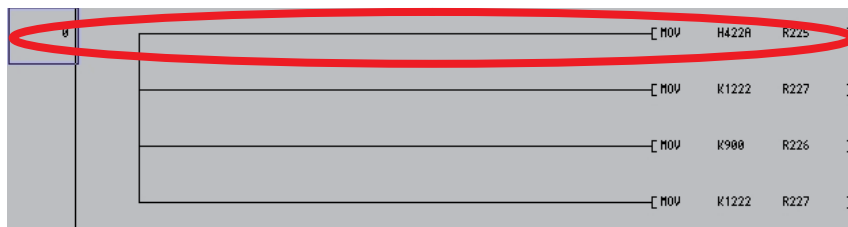

Marking ranges

Ranges can be designated in units of ladder blocks or circuits.

■ Designating the range in ladder blocks

Ranges can be selected in units of ladder blocks using the following procedure.

(1) Move to the position to select the range

Use the basic operation keys to move the cursor to the left end (position displaying the label number and step number) of the ladder block of the desired range.

(2) Display the copy/insert menu.

Pressing the [COPY/INSERT] menu key on the first page of the ladder edit menu changes the menu keys as illustrated in the following diagram.

[[COPY/INSERT] menu]



6 Explanation of Built-in Editing Function (PLC On-board)

6.15 Ladder Menus

(3) Select the range

Press the [SELECT RANGE] menu key in the [COPY/INSERT] menu keys and move the cursor vertically until you reach the last ladder block in the desired range. The background color of the selected range will change to blue.

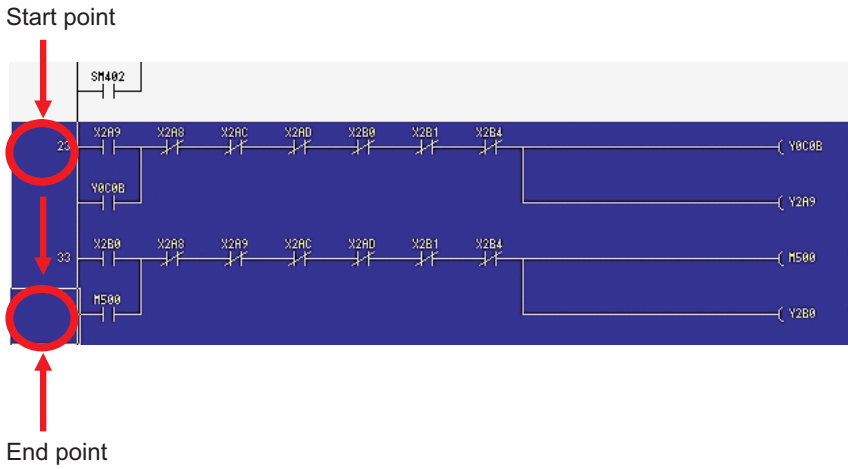

[Restrictions]

The following restrictions apply to ranges selected in ladder blocks.

- Deletes and copy & paste operations cannot be performed in batches on circuits in ranges designated in ladder blocks.

■ Designating ranges in circuits

(1) Move to the position to select the range

Move the cursor to the position of the ladder of the desired range using the basic operation keys.

(2) Display the copy/insert menu.

Pressing the [COPY/INSERT] menu key on the first page of the ladder edit menu changes the menu keys as illustrated in the following diagram.

[[COPY/INSERT] menu]



(3) Select the range

Press the [SELECT RANGE] menu key in the [COPY/INSERT] menu keys and move the cursor horizontally and vertically until you reach the last ladder in the desired range. The background color of the selected range will change to blue.

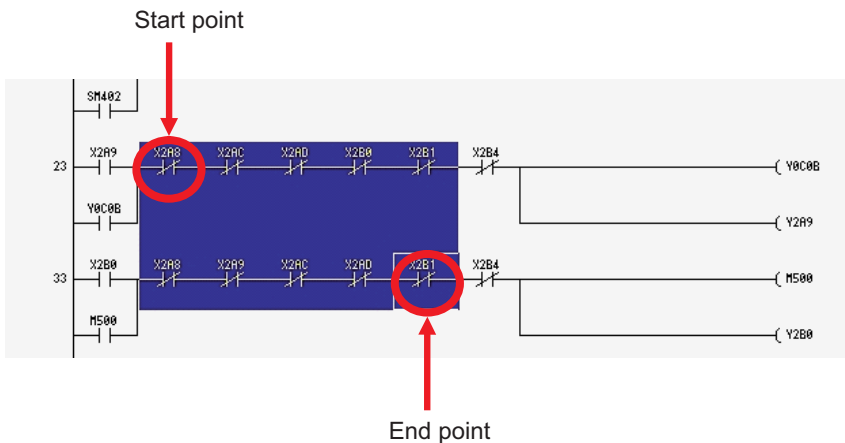

■ Canceling marked ranges

Press the [SELECT RANGE] menu key in the [COPY/INSERT] menu keys again over the selected range (areas with a blue background color) to cancel the range selection and return the background color to the original color.

Batch deletes

Ladder circuits can be deleted in batches using the following procedure.

- (1) Designate the range of circuits to be deleted

Designate the range of circuits to be deleted using the procedure described in "Designating ranges in circuits."

- (2) Delete circuits

While a range of circuits has been designated, press the [DELETE] key to delete all circuits in the range.

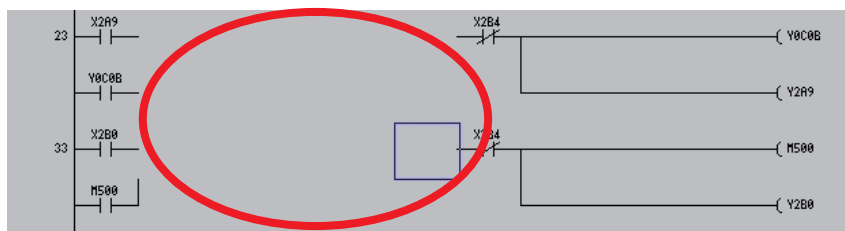

[Restrictions]

The following restrictions apply to batch deletions of circuits.

- Deletes cannot be performed in batches on circuits in ranges designated in ladder blocks.

Copy and paste

Circuits can be copied and pasted at another position or in another program using the following procedure.

- (1) Designate the range of circuits to be copied

Designate the range of circuits to be copied using the procedure described in "Designating ranges in circuits."

- (2) Display the copy/insert menu.

Pressing the [COPY/INSERT] menu key on the first page of the ladder edit menu changes the menu keys as illustrated in the following diagram.

[[COPY/INSERT] menu]

MARK	COPY	PASTE	INSERT LINE	DELETE LINE				CONVERT LADDER	UNDO
------	------	-------	-------------	-------------	--	--	--	----------------	------

- (3) Copy circuits

Press the [COPY] menu key in the [COPY/INSERT] menu keys. Pressing the [COPY] menu key cancels the selected range (blue background color).

If necessary memory could not be secured for the copied ladder, an error is displayed and the selected area to be copied is cleared.

- (4) Move to the position where circuits are to be pasted

Move the cursor to the position where the copied ladder is to be pasted using the basic operation keys.

- (5) Paste the circuits

Press the [PASTE] menu key in the [COPY/INSERT] menu keys. Pressing the [PASTE] menu key pastes the copied ladder into the ladder screen in accordance with the overwrite/insert mode.

[Pasting in overwrite mode]

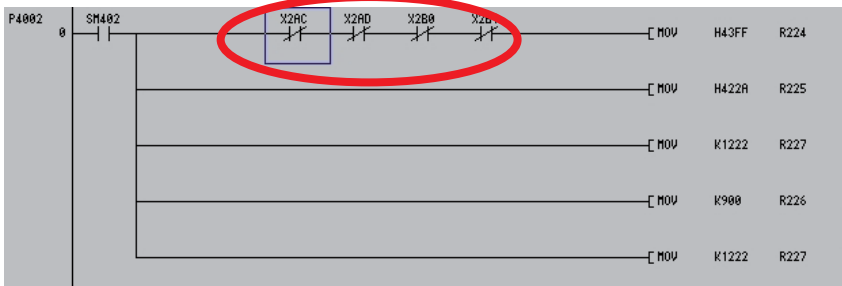

[Pasting in insert mode]

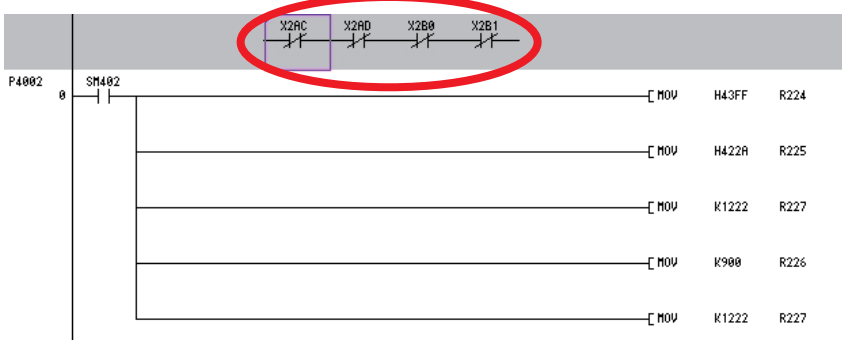

Restrictions when editing ladders

The following information details restrictions when editing ladders.

- Up to 24 lines can be edited in one ladder block.
- Up to 24 lines in one block and up to 48 lines in total can be edited.
- The maximum number of contacts in one ladder line can be changed with the ladder display setting popup screen.
- The master control (MC) symbol cannot be edited. The MC symbol is displayed during ladder monitoring. (The MC symbol does not appear during ladder editing.)
- If a series ladder exceeding the maximum number of contacts is created in one line, the line will automatically return and move to the next line. The return symbol is created with K0 to K99. The OUT (->) and IN (>-) return symbol No. always have to be the same.
- Another ladder cannot be inserted between the OUT (->) line and IN (>-) line of the return line.
- When writing the ladder, the return symbol is assigned with a serial number even if it is not in the same ladder block. Note that in the ladder block read out with the read function, the return number is assigned in order from No. 0.
- If the contact and coil to be overwritten extends over several contacts, the ladder cannot be edited with the write (overwrite) mode.



An instruction that uses multiple contacts such as "[= D0 D1]-" at this position cannot be overwritten in overwrite mode. (This is because the next instruction will also be overwritten.)

If the contact and coil to be overwritten extends over several contacts, the ladder cannot be edited with the write (overwrite) mode.

6 Explanation of Built-in Editing Function (PLC On-board)

6.15 Ladder Menus

- If a return results from the insertion of a contact in the first row of the ladder, the contact cannot be inserted.

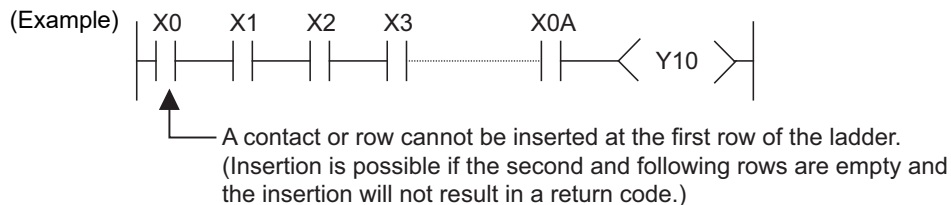

- Insertion of the ladder symbol is processed by right alignment and row insertion, so there may be causes when the symbol cannot be inserted because of the ladder shape.

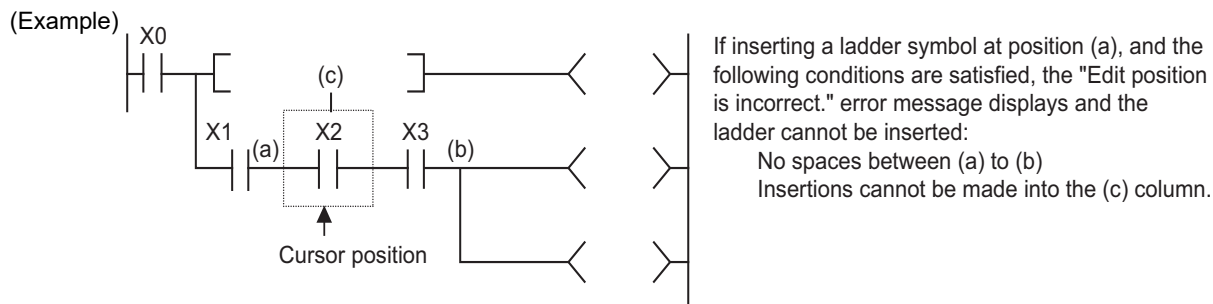

Note

- (1) The position (b) is the closest position to the cursor position among the branch symbols and the coil-equivalent instructions.

- If one ladder block has two or more lines, and the instruction does not fit on one line, enter a new line before entering the instruction.
- Create the number of steps for one ladder block within approximately 4k steps. The NOP instruction in the ladder block is also included in the number of steps. The NOP instruction between ladder blocks is irrelevant.
- If there is an unconverted ladder, the screen movement range may be limited.

6.15.2.7 Converting Programs

Details of edits cannot be checked when using the preceding edit procedures to edit ladders and transitioning to the ladder screen will cause these edits to be lost. For this reason, you perform conversions to check the details of edits.

The currently displayed program will be the program that is converted. The converted details are updated in the program stored in the temporary storage area and so these edits will be lost when the power to the NC is turned off if you do not execute a ROM write operation.

The maximum number of steps that can be converted at one time is 512.

The behavior is different according to the setting of ladder program write during RUN (#6455 bit6/bit7).

This chapter describes the behavior when ladder program writing during RUN is disabled. For the behavior when it is enabled, refer to "6.15.2.11 Ladder Program Writing during RUN by Conversion".

When the PLC is running

If a conversion is executed while the PLC is running, a message confirming whether or not to stop the PLC is displayed.

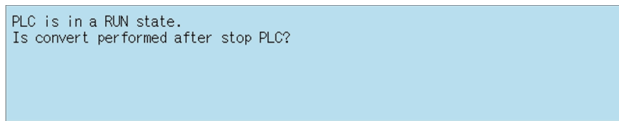

The following information describes the resulting operation depending on whether the [YES] or the [NO] menu key is pressed.

[When [YES] menu key is pressed]

The PLC stops and the conversion process executes. Once the conversion is complete, the background color of the edited portion of the ladder screen (gray) changes to white.

Once the conversion process is complete, a message confirming whether or not to continue running the PLC is displayed.

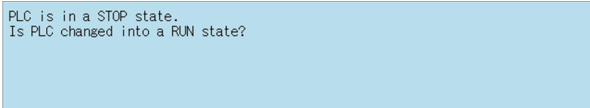

If the [YES] menu key is pressed, the PLC continues running. If the [NO] menu key is pressed, the PLC state is not changed.

[When [NO] menu key is pressed]

The following error message is displayed and the conversion process is canceled.

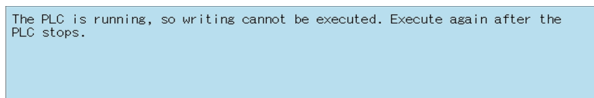

When the PLC is stopped

If the PLC is stopped, the conversion process starts without displaying any confirmation messages. Once the conversion is complete, the background color of the edited portion of the ladder screen (gray) changes to white.

Edit files with write-protect passwords configured

If a password to protect against writes or reads/writes has been configured for the edit files, the cancel password screen is displayed.

Enter the password to cancel the password.

Refer to "6.21 Canceling File Passwords" for information on clearing passwords.



6.15.2.8 Undoing the Last Edit Operation

When editing ladders, you can undo the last edit operation and return the ladder this previous state. This undo operation is only valid for the last single operation.

Use either of the following methods to execute the undo operation.

- Press the [UNDO] menu key
- Press and hold the Ctrl key and then press the Z key.

The following table describes which edit operations can and cannot be undone.

Operations that can be undone	Operations that cannot be undone
Editing contacts/coils/lines/etc. (adds/changes/deletes)	When a ladder is changed, the state prior to the change cannot be restored.
Editing statements/notes	When an unconverted ladder is discarded, the state prior to discarding cannot be restored.
Line insertions/line deletions	Editing circuits in the split display
Pasting in units of ladder blocks	When pasting ladder blocks, the state prior to pasting cannot be restored.

6.15.2.9 Editing Statements

Outline

Statements can be added to the program displayed on the ladder screen.

A statement is text string data added to each ladder block to make it easy to understand the flow of the entire program.

Statements can be edited in accordance with the following restrictions.

	Input character range	Storage destination data type
Statements	64 single-byte alphanumeric characters	Sequence programs

Example display of a statement

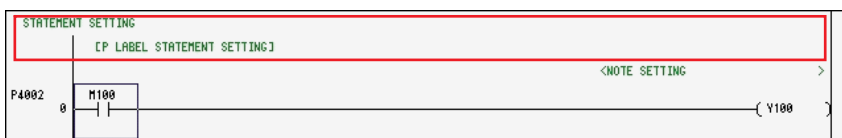

Integrated statements and peripheral statements

Statements include integrated types and peripheral types. Integrated types and peripheral types are designated by the first character in the string.

The first character is an asterisk.	Peripheral statements
The first character is not an asterisk.	Integrated statement

Note the following precautions regarding integrated statements.

Precautions
Saving user PLCs containing an integrated statement is saved in the NC requires a large amount of memory in the user PLC.

Edit method

■ Entering statements between lines

Statements can be entered between ladders using the following procedure.

- (1) Move to the edit position

Move the cursor to the position to the left end of the line where the statement is to be entered using the basic operation keys.

(Refer to "6.15.1.6 Moving the Cursor".)

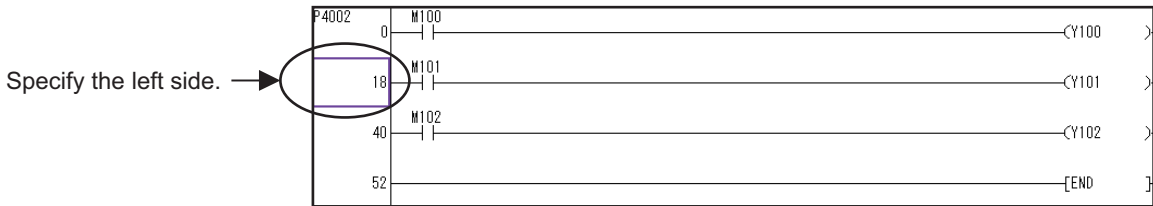

- (2) Switch to the edit mode

Press the [OVR. WRITE/INSERT] menu key to switch to the insert mode.

- (3) Display the enter symbol popup screen

Press the [INPUT] key to display the enter symbol popup screen.

- (4) Enter the statement

Enter the statement into the enter symbol popup screen as in the following example. Add a semicolon at the beginning when entering.

(Example) Entering a statement



After the entry is complete, press the [INPUT] menu key. Press the [INPUT] menu key to input the statement between the lines at the cursor.

- (5) Check the details of edits

After entering the statement, press the [CONVERT LADDER] menu key to confirm the edit. (Refer to "6.15.2.7 Converting Programs")

■ Entering statements into P labels

Statements can be entered into P labels using the following procedure.

- (1) Move to the edit position

Move the cursor to the position of the P label where the statement is to be entered using the basic operation keys. (Refer to "6.15.1.6 Moving the Cursor".)

- (2) Display the enter symbol popup screen

Press the [INPUT] key to display the enter symbol popup screen.

- (3) Enter the statement

Enter the statement into the enter symbol popup screen as in the following example. Add a semicolon after the label when entering.

(Example) Entering a P label statement



After the entry is complete, press the [INPUT] menu key. Press the [INPUT] menu key to input the statement in the P label.

- (4) Check the details of edits

After entering the statement, press the [CONVERT LADDER] menu key to confirm the edit. (Refer to "6.15.2.7 Converting Programs")

6.15.2.10 Editing Notes

Outline

Notes can be added to the program displayed on the ladder screen.

A note, just like a statement, is text string data added to each coil and function instruction to make it easy to understand the flow of the entire program.

Notes can be edited in accordance with the following restrictions.

	Input character range	Storage destination data type
Notes	64 single-byte alphanumeric characters	Sequence programs

Example display of a note

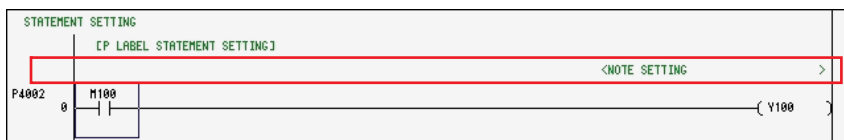

Integrated notes and peripheral notes

Notes include integrated types and peripheral types. Integrated types and peripheral types are designated by the first character in the string.

The first character is an asterisk.	Peripheral note
The first character is not an asterisk.	Integrated note

Note the following precautions regarding integrated notes.

Precautions
Saving user PLCs containing an integrated note is saved in the NC requires a large amount of memory in the user PLC.

Edit method

Notes can be entered using the following procedure.

(1) Move to the edit position

Move the cursor to the position to the function instruction in the line where the note is to be entered using the basic operation keys.

(Refer to "6.15.1.6 Moving the Cursor")

(2) Display the enter symbol popup screen

Press the [INPUT] key to display the enter symbol popup screen.

(3) Enter the note

Enter the note into the enter symbol popup screen as in the following example. Add a semicolon after the instruction when entering.

(Example) Entering a note



After the entry is complete, press the [INPUT] menu key. Press the [INPUT] menu key to input the note.

(4) Check the details of edits

After the inputting the note, press the [CONVERT LADDER] menu key to confirm the edit.

(Refer to "6.15.2.7 Converting Programs")

6.15.2.11 Ladder Program Writing during RUN by Conversion**Outline**

Ladder program writing during RUN (or RUN write) enables to edit and change sequence programs without stopping PLC operation. When RUN write is enabled in bit selection parameter, RUN write will be available with normal operation.

Refer to section "5.6.8 Executing Ladder Program Writing during RUN" for details of RUN write.

⚠ CAUTION

Only the person who knows well about sequence programs can execute sequence program writing during RUN. When the RUN write is enabled, the modification will be immediately effective after the data editing and conversion. The machine might operate in unexpected way when the sequence program is incomplete. Consider well the influence of the modification in advance. Also, always make sure that the system's safe operation with the sequence programs.

RUN write execution

When you execute a conversion during PLC RUN, the following message will appear to confirm whether to continue the RUN write execution.

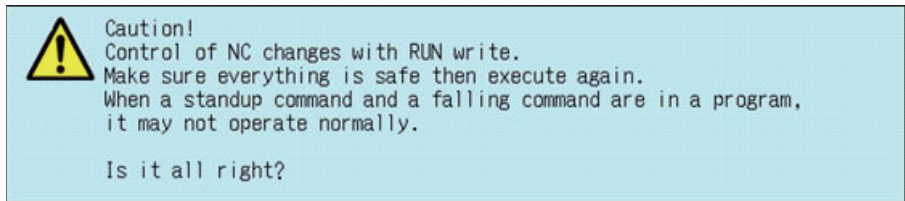

The following information describes the resulting operation by pressing each menu key.

[When [WRITING DURING RUN] key is pressed]

RUN write is executed. Processing time of RUN write depends on the total number of steps used in the ladder programs and the points where the steps are written in (from one second or less to several seconds).

The following message will appear when RUN write is completed.



[When [WRITING AFTER STOP] key is pressed]

The PLC stops and the conversion process executes. Once the conversion is complete, the background color of the edited portion of the ladder screen (gray) changes to white.

After the conversion has been completed, a message confirming whether to have PLC returned to the RUN state is displayed.

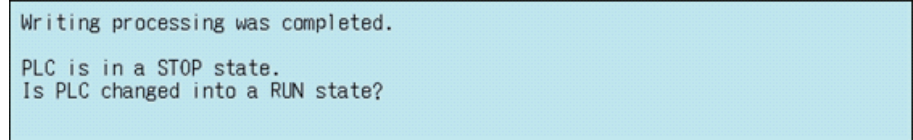

If the [YES] menu key is pressed, the PLC continues running. If the [NO] menu key is pressed, the PLC state is not changed.

[When [CANCEL] key is pressed]

PLC will be back to the state before conversion.

6.15.3 Find Popup Screen

6.15.3.1 Outline

Contacts, coils, and instructions can be searched while editing and monitoring circuits.

Contacts, coils, and instructions can be searched (DEVICE, INST. find), and FB instance name can be searched (find FB Instance) while editing and monitoring circuits.

Find FB instance is available only when operation mode is GX Works2.

Programs and FB, which are created in a programming language which cannot be displayed, cannot be searched.

■ When searching device, instruction

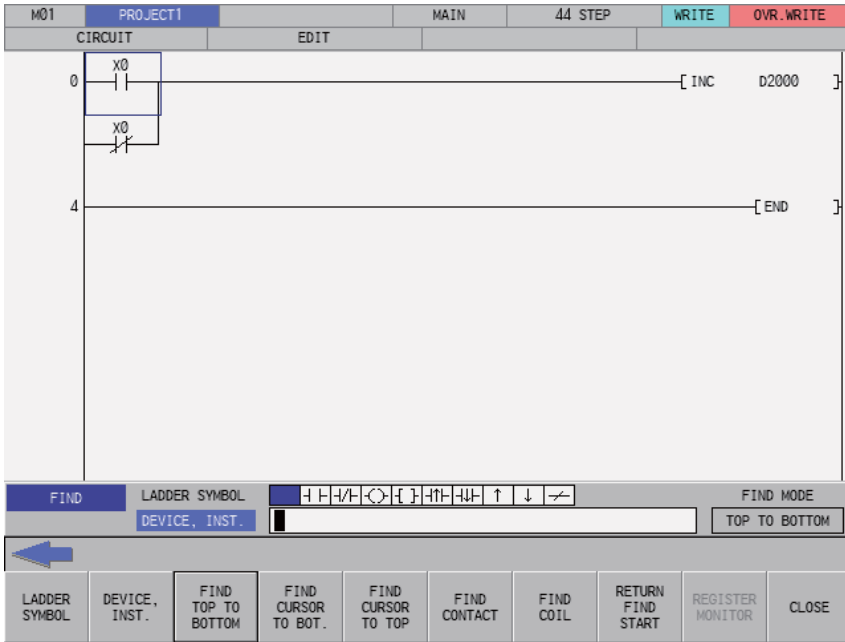

■ When searching FB instance

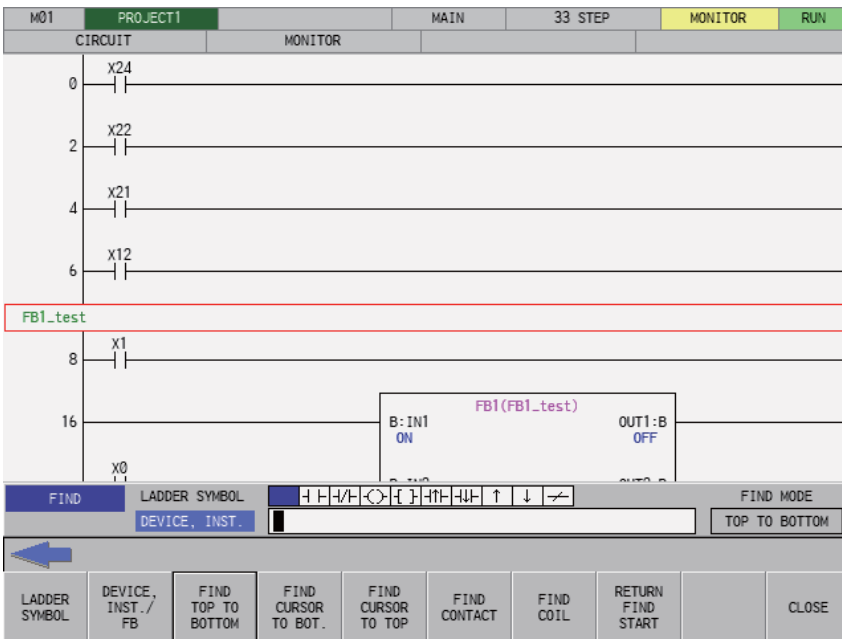

6.15.3.2 Screen Display Items

The following table describes the screen display items for the find popup screen.

Item name	Display state
Ladder symbol	This displays the ladder symbol used in the search. Items are hidden when an FB instance is searched. (*1)
DEVICE, INST.	This displays the device or instruction to be searched. Items are displayed only when a device and an instruction are searched. (*1)
FB Instance	This displays the name of the FB instance to be searched. Items are displayed only when the FB instance is searched. (*1)
Current search mode	This displays the current search mode. Items are displayed only when an FB instance is searched. (*1)

(*1) Refer to " Find function and find target" for the switching method of find DEVICE, INST./FB instance.

6.15.3.3 Enabled/Disabled State of Menu Keys

The following table describes the conditions upon which menu keys displayed on the find popup screen are enabled/disabled.

The menu keys which are not described in the following table are always enabled.

Menu name	Condition upon which it is enabled/disabled
REGISTER MONITOR	Enabled when the ladder screen is selected and being in monitoring. Hidden when operation mode of the project is GX Works2.

6.15.3.4 Status during Screen Displays

The following table describes the status when displaying the find popup screen.

Item name	Operation
Ladder symbol	This selects the ladder symbol at the cursor position.
DEVICE, INST.	This displays the device name at the cursor position. This also sets the alias for the device at the cursor position and displays the alias if attempting to display the alias. When the label name is set for the device at the cursor position, the label name is displayed. If the cursor position is an FB, "FB instance name.label name" is displayed. This is left blank if there is no device at the cursor position. This is the default focus position when the screen is displayed.
Current search mode	This displays from the top to the bottom.

6.15.3.5 Operation of Key Presses

The following table describes the operation of each menu key and the keys on the NC keyboard when pressed.

Item name	Operation
Left arrow key	Refer to "6.15.3.11 Closing the Find Popup Screen".
Ladder symbol	This selects the ladder symbol selection or changes the ladder symbol selection. Disabled when operation mode is GX Works2 and when searching FB instance.
DEVICE, INST.	Select "DEVICE, INST." input field. Displayed and enabled only when operation mode is GX Developer.
DEVICE, INST./ FB	Select "DEVICE, INST." input field or "FB Instance" input field. This switches the target to search if this is already selected. Displayed and enabled only when operation mode is GX Works2.
Find top to bottom	Refer to "6.15.3.7 Find Operation". Searching contacts and coils is disabled when operation mode is GX Works2 and when searching FB instance.
Find cursor to bottom	
Find cursor to top	
Find contact	
Find coil	
Return to the start position	Refer to "6.15.3.8 Returning to the Start Position".
Register Monitor	Refer to "6.15.3.9 Register Monitor Operation".
Close	Refer to "6.15.3.11 Closing the Find Popup Screen".

6.15.3.6 Displaying the Find Popup Screen

The display method for the find popup screen differs depending on the state of the ladder screen.

The following table describes the display method for the find popup screen.

State of the ladder screen	Display method for the find popup screen
Ladder screen is selected	
Monitoring	Press the [FIND] menu key.
	Press the [INPUT] key.(*1)
	Press any character key.
Edit	Press the [FIND] menu key.
Entry ladder monitor is selected	
Monitoring	Press the [FIND] menu key.
	Press the [INPUT] key.
	Press any character key.
FB Instance monitor is selected	
Monitoring	Press the [FIND] menu key.
	Press the [INPUT] key.(*1)
	Press any character key.

(*1) Only when the cursor is not on an FB.

When the cursor is on an FB, FB instance monitor screen is displayed.

The following message is displayed when attempting to display the find screen when a ladder is being edited (area with a gray background color).

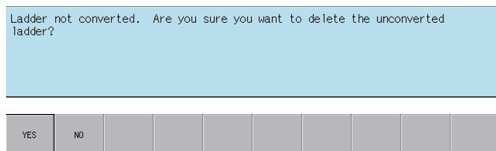

Pressing the [NO] menu key returns to the ladder screen without displaying the find screen.

Pressing the [YES] menu key cancels the edits made to the ladder, returns the ladder to its previous state before editing, and then displays the find popup screen.

6.15.3.7 Find Operation

Find function and find target

There are "DEVICE, INST. Find" and "Find FB Instance" for find function.

Find function	Find target	Example of inputting find character string	Find enabled mode
DEVICE, INST. Find	DEVICE	LADDER SYMBOL: [H][H][H][H][O][H][H] DEVICE, INST.: X1	No restriction
	Instruction	LADDER SYMBOL: [H][H][H][H][O][H][H] DEVICE, INST.: FMOV	No restriction
	Aliases	LADDER SYMBOL: [H][H][H][H][O][H][H] DEVICE, INST.: .OPEN	GX Developer mode
	Label name	LADDER SYMBOL: [H][H][H][H][O][H][H] DEVICE, INST.: OPEN1	GX Works2 mode
Find FB Instance	FB Instance name	LADDER SYMBOL: [H][H][H][H][O][H][H] DEVICE, INST.: FB1_INSTANCE	GX Works2 mode

Press the [DEVICE, INST./FB] menu keys to switch the find function.

After the find function is switched with the menu key, settings of ladder symbol, find character string input state, and current find mode are not changed. Ladder symbols are hidden when finding FB instance but return to the settings before switching after switching to DEVICE, INST. find.

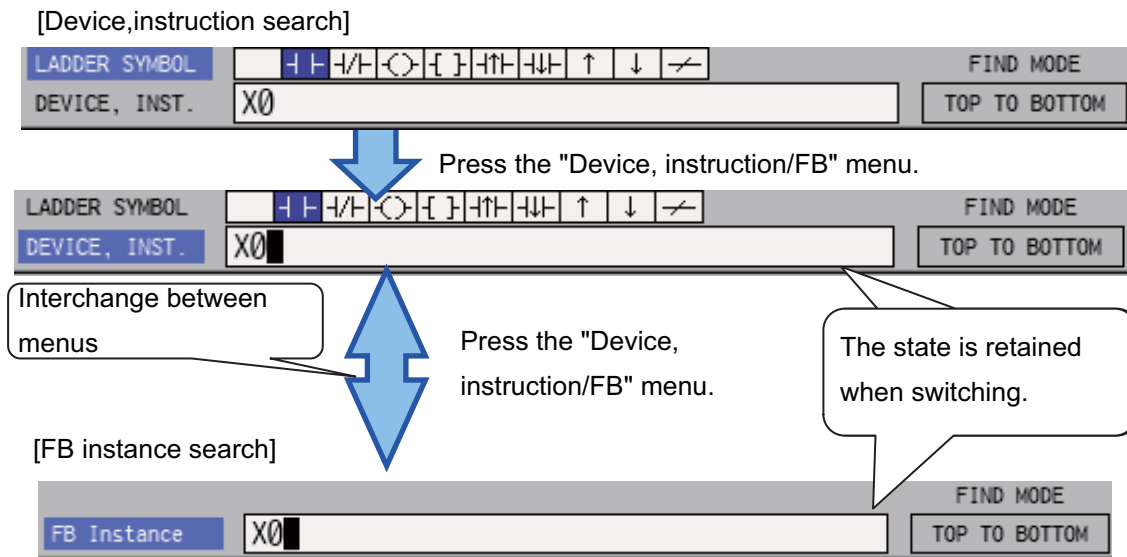

The following table describes search conditions for each find function.

Find condition	Find function	
	DEVICE, INST. Find	Find FB Instance
Case sensitive	No	No
Find in term units	Term units	Not term units (partial match)

Normal find (DEVICE, INST. find)

- (1) When input item is "FB Instance", press the [DEVICE, INST./FB] menu to switch to "DEVICE, INST.".
- (2) Press the [LADDER SYMBOL] menu and select the ladder symbol for the ladder to be searched.
Ladder symbols can be searched even if not selected.
- (3) Press the [DEVICE, INST.] menu and then enter either the device or instruction to be searched into the "DEVICE, INST." input field.
- (4) To execute the corresponding find operation, press either the [INPUT] key or one of the following menu keys: [FIND TOP TO BOTTOM], [FIND CURSOR TO BOT.], [FIND CURSOR TO TOP], [FIND CONTACT], and [FIND COIL]. If the search finds a match, the cursor moves to the position where the match was found.

The following table describes the direction and types of searches.

Menu item	Search direction and type
Find top to bottom	This searches the designated device or instruction from the top of the currently displayed program. The find top to bottom search is performed when displaying the find popup screen and pressing the [INPUT] key.
Find cursor to bottom	This searches the designated device or instruction downward from the cursor position.
Find cursor to top	This searches the designated device or instruction upward from the cursor position.
Find contact	This searches the designated device contact instruction from the top of the currently displayed program. The status of [LADDER SYMBOL] is ignored at this time. (Example: When a contact is searched in the "-(-) M0" state, the M0 contact is searched instead of resulting in an error.)
Find coil	This searches the designated device coil instruction from the top of the program. The status of [LADDER SYMBOL] is ignored at this time.

■ Continuous search

Perform the following operations to search continuously.

- Once the search is started after pressing the [INPUT] keys or one of the search menu keys, the executed search menu key changes to [FIND NEXT].
- Press the [FIND NEXT] menu key or the [INPUT] key to continue the search.

■ Consecutive searching of multiple programs

When multiple programs are opened, the program is searched until the end of the program. Then the following message is displayed and the search can continue on to the next program.

[When a search match is found in the first program:]

"Search completed. Search another program?"

A program or FB created in the programming languages which cannot be displayed will not be searched."

The message is not displayed after the second program.

[When a search match is not found in the first program:]

"The find target could not be found. Find another program."

A program or FB created in the programming languages which cannot be displayed will not be searched."

The message is not displayed after the second program.

The search ends if the [NO] menu key is pressed.

The search continues to the next program if the [YES] menu key is pressed. A message "Find is complete." is displayed when all programs have been searched. An error message appears.

Pressing the [OK] menu key closes the message and returns to the find popup screen.

(Example)

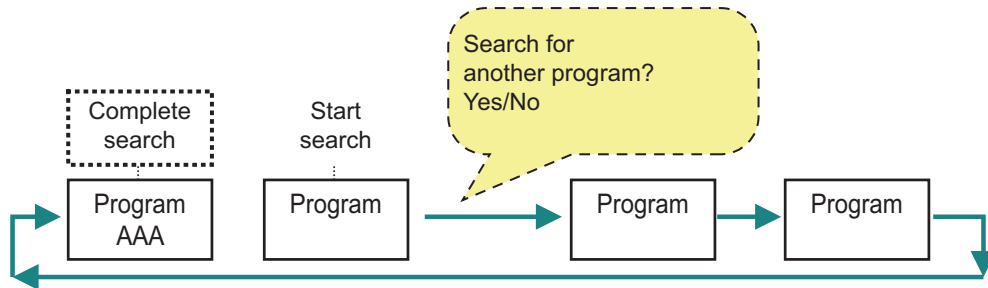

■ Find device in FB

Devices and instructions in FB can also be searched as programs.

Screen displayed differs depending on the status when searching.

[When searching during FB instance monitor]

Devices and instructions in displayed FB instance. When searching other programs after completing the search, FB instance monitor ends.

[When searching at times other than during FB instance monitor]

In the procedure of consecutively searching multiple programs, FB is also the target when searching other programs. Since the searching is performed by FB definition and not FB instance, all the ON/OFF status and values of devices are not displayed.

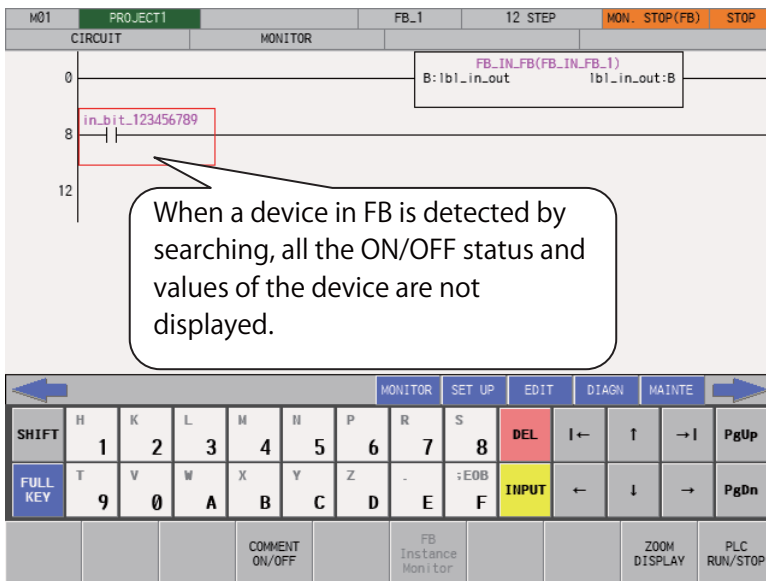

When transitioning to FB definition by searching, [FB Instance Monitor] menu is disabled. Double-tapping on the existing FB in the screen or pressing the [INPUT] key does not transit to the FB instance monitor screen.

The screen does not transition to the FB instance monitor screen by double-tapping or pressing the INPUT key.



Refer to "6.15.1 Ladder Monitor" since specifications and operations are the same as ladder monitor screen.

Note

- (1) When the find target POU is locked with a block password and the password is not temporarily cleared with PLC on-board, the POU cannot be searched as reading it is not permitted. The POU is not searched and the other programs are searched.

Temporarily clear the block password to search. Refer to "6.15.11 Block Password Disable screen" for how to disable.

Consecutive searching of multiple projects

Ladder searches cannot be performed across multiple projects. Change to a different project and execute the search again.

Search using the alias

Searches can be performed using aliases in the same way as for devices by specifying the alias configured for the device into the [DEVICE/INST.] input field. Only aliases configured with single-byte alphanumeric characters can be searched by the PLC On-board.

Use either of the following formats to specify the alias.

- "Single quotation mark" + "Desired alias"
- "Period" + "Desired alias"

Changes to the direction and type of search and continuous searches are performed in the same way as for normal searches.

Search using the label name

Specify the label name in "DEVICE, INST." input field to search in the same way as a device. Only label names set with single-byte alphanumeric characters can be searched by PLC on-board.

Find FB Instance

For GX Works2 mode, FB instance find is enabled. FB instance find uses the FB instance name as the key to search as shown in the following figure.

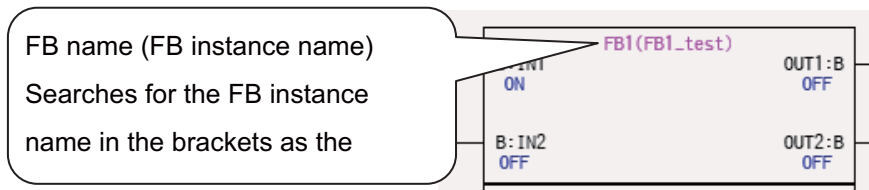

The following are the FB instance find procedures.

- (1) When input item is "DEVICE/INST.", press the [DEVICE, INST./FB] menu to switch the find target to FB instance.
- (2) Enter the FB instance name to search for in the FB instance input field. Only FB instance names set with single-byte alphanumeric characters can be searched by PLC on-board.
- (3) To execute the corresponding find operation, press either the [INPUT] key or one of the following menu keys: [FIND TOP TO BOTTOM], [FIND CURSOR TO BOT.], [FIND CURSOR TO TOP], [FIND CONTACT], and [FIND COIL]. If the search finds a match, the cursor moves to the position (top left of the FB) where the match was found.

The following table describes the direction and types of searches.

Menu item	Search direction and type
Find top to bottom	This searches the designated FB instance name from the top of the currently displayed program. Search from top to bottom is also performed after displaying the find popup screen and pressing the [INPUT] key to switch to find FB instance.
Find cursor to bottom	This searches the designated FB instance name downward from the cursor position.
Find cursor to top	This searches the designated FB instance name upward from the cursor position.

Continuous search and consecutive searching of multiple programs are the same as "Normal find (DEVICE, INST. find)". Ladder searches cannot be performed across multiple projects. Change to a different project and execute the search again.

6.15.3.8 Returning to the Start Position

Pressing the [RETURN TO START POSITION] menu key enables you to return to the step position when the search was started in the program that was displayed when the search was started. The [FIND START] position is updated if a new search is started.

6.15.3.9 Register Monitor Operation

Pressing the [REGISTER MONITOR] menu key enables you to register ladders including the cursor position device and cursor position into the split screen entry ladder monitor screen or the entry device monitor screen.

Use the following procedures to register to these registration monitors.

Registering to the entry ladder monitor

Ladders including the cursor position can be registered to the entry ladder monitor for the following cases.

- Pressing the [REGISTER MONITOR] menu key when not using the split screen mode.
- Pressing the [REGISTER MONITOR] menu key when displaying the entry ladder monitor.

Registering to the entry device monitor

Devices at the cursor position can be registered to the entry ladder monitor for the following cases.

- Pressing the [REGISTER MONITOR] menu key when displaying the entry device monitor.

6.15.3.10 Find Popup Screen Errors

This information describes the details of error messages displayed on the find popup screen and the corrective action thereof.

Error message	Error details	Remedy
Device setting is wrong. The following causes may be responsible: • The device No. is over the usable range. • An unusable device has been designated.	This is displayed when the search-related menu keys are pressed when the range of the specified device is unusable or an unusable device is specified.	Enter a suitable device into the "DEVICE, INST." input field and then press a search-related menu key again.
Device setting is wrong. The following causes may be responsible: • An unusable device has been designated. • Index modification, module specification setting is wrong. • Special function module device, link direct device setting is wrong.	This is displayed when the search-related menu keys are pressed when the range of the specified device is unusable or a mistake was made in the specification of the index modification, module specification, etc.	Enter a suitable device into the "DEVICE, INST." input field and then press a search-related menu key again.
The relationship between the ladder code and instruction is incorrect. Change one of them.	This is displayed when search-related menu keys are pressed when the ladder symbol and instruction do not match. <Example> Ladder symbol: -[]- Device/instruction: LD	Correct the relationship between the ladder symbol and instruction and then press a search-related menu key again. <Example> Ladder symbol: -[]- Device/instruction: MOV
The instruction or device is incorrect.	This is displayed when the search-related menu keys are pressed when a non-existent device or non-existent instruction is entered into the device/instruction input field without selecting a ladder symbol.	Enter an existing device or instruction into the "DEVICE, INST." input field and then press a search-related menu key again.
A device that corresponds to the alias has not been assigned. Check the device comment window.	This is displayed when the search-related menu keys are pressed after entering an alias not allocated to a device.	Enter an alias allocated to a device and then press a search-related menu key again.
The entered device name is incorrect. Enter the correct device name.	This is displayed when the search-related menu key is pressed when something other than FIND device was entered. <Example> The start character is "_" (underscore)	Enter a suitable device into the "DEVICE, INST." input field and then press a search-related menu.
The entered FB instance name is incorrect. Enter correct FB Instance name.	This is displayed when the search-related menu key is pressed when "FB Instance name" input field is blank or instance name which cannot be searched is entered.	Enter a suitable name into the "FB Instance name" input field and then press the search-related menu.

6.15.3.11 Closing the Find Popup Screen

Use any of the following methods to close the find popup screen.

Methods to close the screen
Press the [CLOSE] menu key.
Press the left arrow key.
Press the [ESC] key on the software keyboard.

6.15.4 Find Step No. Popup Screen

6.15.4.1 Outline

This enables transitions to the specified step position when editing and monitoring ladders.

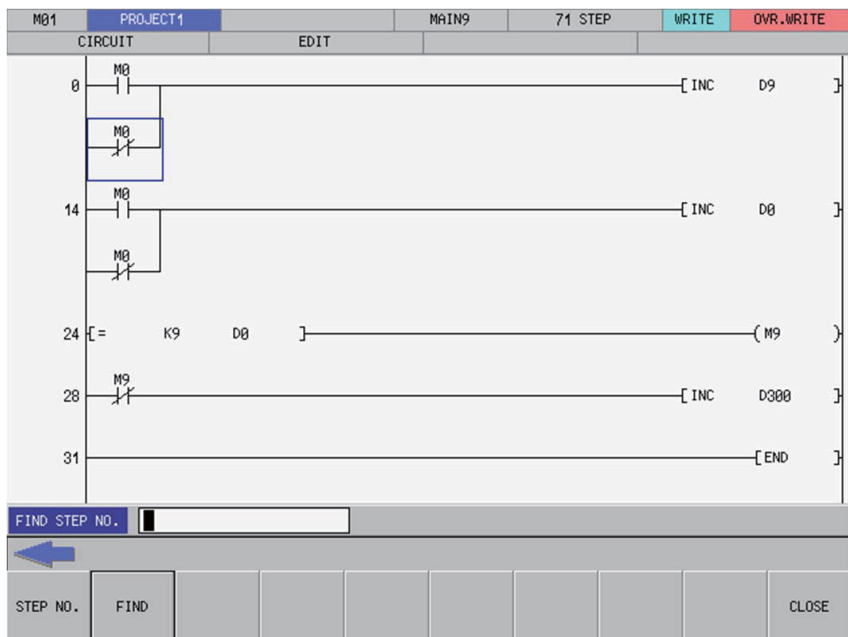

6.15.4.2 Screen Display Items

The following table describes the screen display items for the find step No. popup screen.

Item name	Display state
Find step No.	This displays the step No. position to which you want to transition.

6.15.4.3 Enabled/Disabled State of Menu Keys

The menu keys displayed on the find step No. popup screen are always enabled.

6.15.4.4 Status during Screen Displays

The following table describes the status when displaying the find step No. popup screen.

Item name	Operation
Find step No.	This is left blank. This is the default focus position when the screen is displayed.

6.15.4.5 Operation of Key Presses

The following table describes the operation of each menu key and the keys on the NC keyboard when pressed.

Item name	Operation
Left arrow key	Refer to "6.15.4.8 Closing the Find Step No. Popup Screen".
Find step No.	This selects the find step No. input field.
Find	Refer to "6.15.4.7 Finding Step Numbers".
Close	Refer to "6.15.4.8 Closing the Find Step No. Popup Screen".

6.15.4.6 Displaying the Find Step No. Popup Screen

The find step No. popup screen can be displayed using several different methods.

The following table describes the display method for the find step No. popup screen.

Display method for the Find step No. popup screen
Press the [FIND STEP NO.] menu key.
Press any number key.

6.15.4.7 Finding Step Numbers

Normal operation

- (1) Press the [FIND STEP NO.] menu key and enter the desired step number into find step No. input field.
- (2) Press the [FIND] menu key. Pressing the menu key closes the find step No. popup screen and transitions the cursor to the entered position.

If the entered step number is larger than the number of steps in the ladder, the cursor is transitioned to the ladder end position.

Abnormal operation

This information describes the details of error messages displayed on the find step No. popup screen and the corrective action thereof.

Error message	Error details	Remedy
The specified step is out of the range. Set a valid step No.	This is displayed when an incorrect step number is specified such as setting a negative number in the find step No. input field.	Enter a positive integer into the find step No. input field and press the [FIND] menu key again.

6.15.4.8 Closing the Find Step No. Popup Screen

Use any of the following methods to close the find step No. popup screen.

Methods to close the screen
Execute the find step No. operation.
Press the [CLOSE] menu key.
Press the left arrow key.
Press the [ESC] key on the software keyboard.

6.15.5 Device Test Popup Screen

6.15.5.1 Outline

The bit devices can be turned ON and OFF forcibly and the word device current value can be changed.

[Bit device setting screen (ladder screen)]

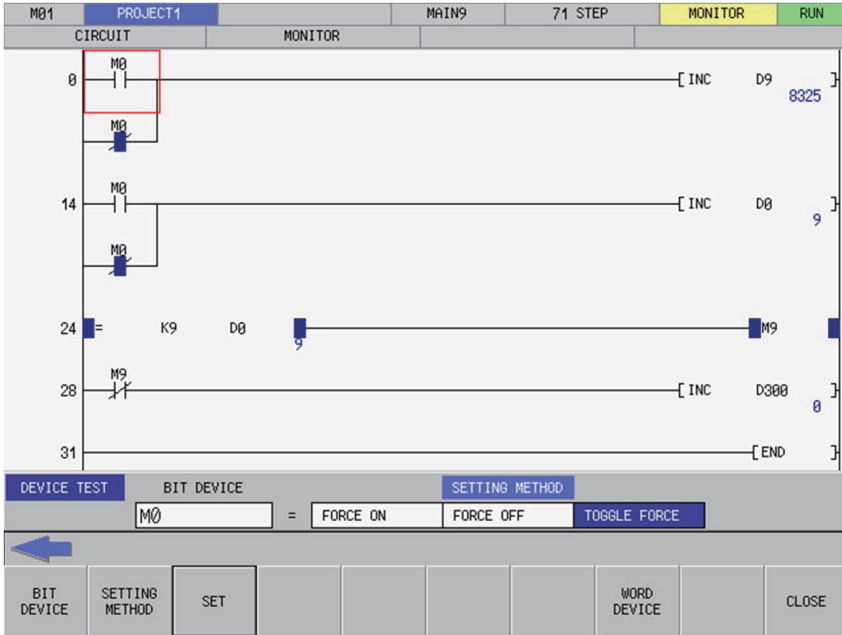

[Word device setting screen (ladder screen)]

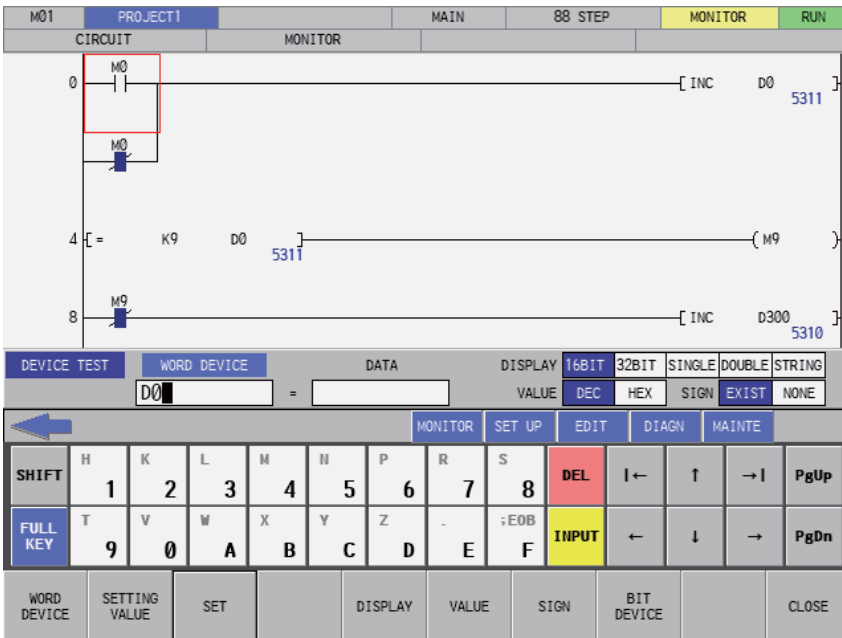

6.15.5.2 Screen Display Items

The following table describes the screen display items for the device test popup screen.

Item name		Display state
Bit device setting screen		
	Bit device	This displays the bit device at the cursor position. This is left blank if there is no bit device.
	Device ON/OFF settings	This displays the forced ON, forced OFF, and toggle between forced ON/OFF.
Word device setting screen		
	Word device	This displays the word device at the cursor position. This is left blank if there is no word device.
	Setting value	This displays the value set for the word device. This is left blank when displaying screens.
	Display	This displays the [16 BIT], [32 BIT], [Single Precision], [Double Precision] and [String] options.
	Format	This displays values in either decimal or hexadecimal format.
	Sign	This displays the [Signed] or [Unsigned].

6.15.5.3 Enabled/Disabled State of Menu Keys

The menu keys displayed on the device test popup screen are always enabled.

6.15.5.4 Status during Screen Displays

The following table describes the status when displaying the device test popup screen.

Item name		Operation
Bit device setting screen		
	Bit device	This is the default focus position when the screen is displayed. This displays the bit device at the cursor position. This is left blank if there is no bit device.
	Setting method	This selects the toggle between forced ON/OFF.
Word device setting screen		
	Word device	This displays the word device at the cursor position. This is left blank if there is no word device.
	Setting value	This is left blank.
	Display	This selects the display which matches the label types at the cursor position. 16-bit is selected if there is no label.
	Format	This selects decimal numbers.
	Sign	This selects the sign which matches the label types at the cursor position. This selects the [YES] option if there is no label.

6.15.5.5 Operation of Key Presses

The following table describes the operation of each menu key and the keys on the NC keyboard when pressed.

Menu name	Operation
Left arrow key	Refer to "6.15.5.8 Closing the Device Test Popup Screen".
Bit device setting screen	
Bit device	This selects the bit device input field.
Setting method	This sets the focus to the device ON/OFF setting. This changes the setting method selection when the focus is already set.
Settings	Refer to "6.15.5.6 Testing Bit Devices".
Switch word device	This switches to the word device setting screen.
Close	Refer to "6.15.5.8 Closing the Device Test Popup Screen".
Word device setting screen	
Word device	This selects the word device input field.
Setting value	This selects the setting value input field.
Settings	Refer to "6.15.5.7 Testing Word Devices".
Display	This sets the focus to the display. This changes the display selection when the focus is already set.
Format	This sets the focus to the format. This changes the format selection when the focus is already set.
Sign	Sets the focus to the sign. This changes the sign selection when the focus is already set.
Switch bit device	This switches to the bit device setting screen.
Close	Refer to "6.15.5.8 Closing the Device Test Popup Screen".

6.15.5.6 Testing Bit Devices

Normal operation

- (1) Press the [BIT DEVICE] menu key and enter the desired bit device.
- (2) Press or press and hold the [SETTING METHOD] menu key in accordance with the following conditions.
 - ♦ To use a forced ON: Select [FORCE ON].
 - ♦ To use a forced OFF: Select [FORCE OFF].
 - ♦ To toggle between forced ON/OFF: Select [TOGGLE FORCE].
- (3) Press the [SET] menu key.

Abnormal operation

This information describes the details of error messages displayed when testing bit devices and the corrective action thereof.

Error message	Error details	Remedy
The device name has not been entered. Enter the device name.	This is displayed when the [SET] menu key is pressed without entering the device name.	Enter the bit device before pressing the [SET] menu key.
The device is incorrect. Specify a bit device.	This is displayed when the [SET] menu key is pressed when something other than a bit device was entered.	Enter the bit device before pressing the [SET] menu key.
The device No. is outside the range. Check using the parameter device.	This is displayed when the [SET] menu key is pressed when a device outside of the range is specified in the bit device name input field.	Enter a bit device number within range before pressing the [SET] menu key.
Label types and settings do not match. Set to match label types.	This is displayed by pressing "Settings" menu key when the label type is word.	Change to the word device test, set the format selected in "Display", "Sign" selection field to match label type, then press the [SET] menu key.

6.15.5.7 Testing Word Devices

Format and sign settings are applied when 16-bit integer or 32-bit integer is selected in display selection field. Format and sign settings are not applied when real number or string is selected in display selection field.

View	Format	Sign
16-bit integer	○	○
32-bit integer	○	○
FLOAT (Single Precision)	×	×
FLOAT (Double Precision)	×	×
String	×	×

Normal operation

- (1) Press the "View" menu and select the display format (16-bit display, 32-bit display, single precision display, double precision display, and string display) of the device.
- (2) Press the [FORMAT] menu key and select whether the device setting values are entered as decimal or hexadecimal numbers.
- (3) Press the [Sign] menu and select whether the device setting values are signed or unsigned.
- (4) Press the [WORD DEVICE] menu key and enter the desired word device.
- (5) Press the "SETTING VALUE" menu key and enter the desired value.

Note the following points when entering character strings in "SETTING VALUE".

- Up to two bytes for devices and the number of bytes (1 to 255 bytes) set at label creation for labels can be input.
- As NULL code is added at the end of the input character when 2-byte long characters are input for devices, NULL code is input to the next device.

- (6) Press the [SET] menu key. An error occurs when setting a value with a different format from that set in "Display", "Format", and "Sign".

Abnormal operation

Error message	Error details	Remedy
The device name has not been entered. Enter the device name.	This is displayed when the [SET] menu key is pressed without entering the device name.	Enter the word device before pressing the [SET] menu key.
The device is incorrect. Specify a word device.	This is displayed when the [SET] menu key is pressed when something other than a word device was entered.	Enter the word device before pressing the [SET] menu key.
A value has not been entered.	This is displayed when the [SET] menu key is pressed without entering a setting value.	Enter a setting value before pressing the [SET] menu key.
The device No. is outside the range. Check using the parameter device.	This is displayed when the [SET] menu key is pressed when a device outside of the range is specified in the word device name input field.	Enter a word device number within range before pressing the [SET] menu key.
The device setting exceeds the valid range. Check the input value.	This is displayed when the [SET] menu key is pressed when a value outside the valid range of the device is specified in the "Setting value" input field.	Enter a value within the valid range of the device, then press the [SET] menu key.
The device setting is incorrect. Enter the correct number.	This is displayed when the [SET] menu key is pressed when values which do not match the format selected in "Display", "Format", and "Sign" selection field are input in the "Setting value" input field.	Press the [SET] menu key after values which match the format selected in "Display", "Format", and "Sign" selection field are input in the "Setting value" input field.
Label types and settings do not match. Set to match label types.	This is displayed when the [SET] menu key is pressed when the label type and the format selected in "Display" and "Sign" selection field do not match.	Set the format selected in "Display" and "Sign" selection field to match the label type, then press the [SET] menu key.

6.15.5.8 Closing the Device Test Popup Screen

Use any of the following methods to close the device test popup screen.

Methods to close the screen
Press the [CLOSE] menu key.
Press the left arrow key.
Press the [ESC] key on the software keyboard.

6.15.5.9 Precautions when Executing Device Test with Label Name

A device test can be executed by inputting label name instead of bit device name or word device name.

Note the following points.

- A device test with label name is executed for the device of the program currently displayed.
- When the name of a global label and a local label are the same, the device test is executed for the device of the local label.
- When a device test is executed on a screen other than the ladder monitor, the device test is executed for the label of the the program displayed on the ladder monitor.
- When a label name is input instead of a word device name, if the label type and the format selected in "Display" and "Sign" selection field do not match, the device test cannot be executed.

6.15.6 Contact Coil Usage List Popup Screen

6.15.6.1 Outline

The steps, instructions and position in which the designated device is used can be listed.

The program searched is the one stored in the current project.

The program cannot be searched by label name.

This screen cannot be used when the operation mode is GX Works 2.

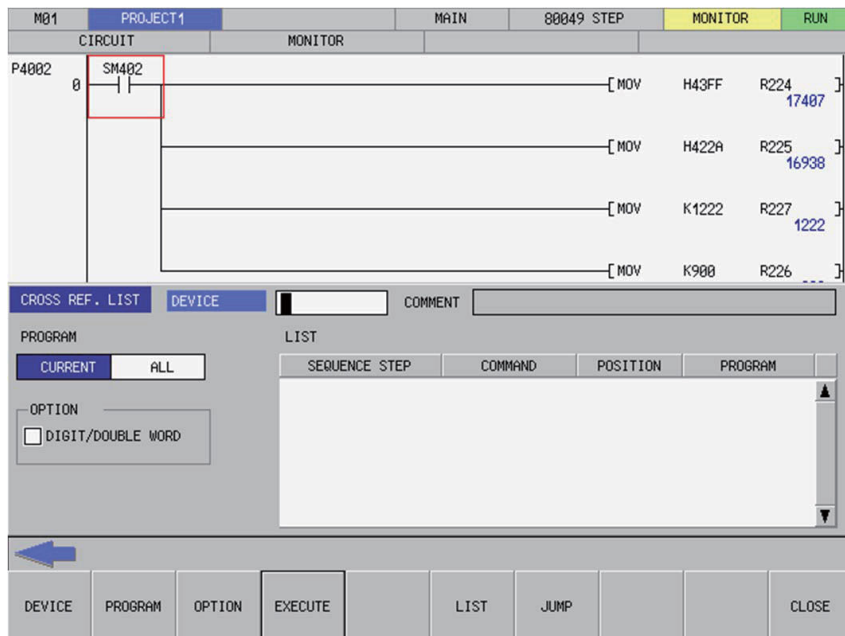

6.15.6.2 Screen Display Items

The following table describes the screen display items for the contact coil usage list popup screen.

Item name	Display state
Device	This displays the device to be searched.
Comment	This displays comments set for the device to be searched.
Program	This displays the currently displayed or all programs.
Options	This displays specified search options for digits/double words.
List	This displays the search results.

6.15.6.3 Enabled/Disabled State of Menu Keys

The menu keys displayed on the contact coil usage list popup screen are always enabled.

6.15.6.4 Status during Screen Displays

The following table describes the status when displaying the contact coil usage list popup screen.

Item name	Operation
Device	This displays the device at the cursor position in the ladder screen. This also sets the alias for the device at the cursor position and displays the alias if attempting to display the alias. This is left blank if there is no device at the cursor position. This is the default focus position when the screen is displayed.
Comment	This is left blank.
Program	This selects the current display.
Options	The check box is deselected.
List	This is left blank.

6.15.6.5 Operation of Key Presses

The following table describes the operation of each menu key and the keys on the NC keyboard when pressed.

Item name	Operation
Left arrow key	Refer to "6.15.6.7 Closing the Contact Coil Usage List Popup Screen".
Device	This selects the device input field.
Program	This selects the search program selection field or changes the selection of the program to be searched.
Options	This selects the search options selection field or changes the selection of the search options.
Execute	Refer to "6.15.6.6 Investigating Usage States of Specified Devices".
List	This selects the list.
Jump	This moves the cursor on the ladder screen to the step position selected in the list.
Close	Refer to "6.15.6.7 Closing the Contact Coil Usage List Popup Screen".

6.15.6.6 Investigating Usage States of Specified Devices

Normal operation

■ When devices are used

- Press the [DEVICE] menu key and enter the device for which you want to investigate the usage state.
- Press the [PROGRAM] menu key and select whether the program to be searched is the currently displayed program or the entire program stored in the current project.
- Press the [OPTION] menu key and select whether or not to use the search option.
- Press the [EXECUTE] menu key to investigate the usage state. The investigation results are displayed in the list. Comments specified for the searched device are displayed in the comment field.
- Press the [LIST] menu key to select the list. Use the up/down arrow keys, Page Up key, and Page Down key to select the area of the ladder you want to check.
- Press the [JUMP] menu key. Move the cursor on the ladder screen to the program or step position present in the ladder selected in the list.

When aliases are used

Usage states can be investigated using aliases in the same way as for devices by specifying the alias configured for the device into the [DEVICE/INST.] input field. Only aliases configured with single-byte alphanumeric characters can be investigated by the PLC On-board.

Use either of the following formats to specify the alias.

- "Single quotation mark" + "Desired alias"
- "Period" + "Desired alias"

Processes other than device specifications are performed in the same way as normal.

Abnormal operation

This information describes the details of error messages displayed on the contact coil usage list popup screen and the corrective action thereof.

Error message	Error details	Remedy
Device setting is wrong. The following causes may be responsible: <ul style="list-style-type: none"> • An unusable device has been designated. • Index modification, module specification setting is wrong. • Special function module device, link direct device setting is wrong. 	This is displayed when the [EXECUTE] menu key is pressed when the range of the specified device is unusable or a mistake was made in the specification of the index modification, module specification, etc.	Enter a suitable device into the device/instruction input field and then press the [EXECUTE] menu key again.
Device setting is wrong. The following causes may be responsible: <ul style="list-style-type: none"> • The device No. is over the usable range. • An unusable device has been designated. 	This is displayed when the [EXECUTE] menu key is pressed when the range of the specified device is unusable or an unusable device is specified.	Enter a suitable device into the device/instruction input field and then press the [EXECUTE] menu key again.
A device that corresponds to the alias has not been assigned. Check the device comment window.	This is displayed when the [EXECUTE] menu key is pressed after entering an alias not allocated to a device.	Enter an alias allocated to a device and then press the [EXECUTE] menu key again.

6.15.6.7 Closing the Contact Coil Usage List Popup Screen

Use any of the following methods to close the contact coil usage list popup screen.

Methods to close the screen
Press the [CLOSE] menu key.
Press the left arrow key.
Press the [ESC] key on the software keyboard.

6.15.7 List of Used Devices Popup Screen

6.15.7.1 Outline

The usage state of devices in the program can be displayed for each designated device. The ladder symbols, usage quantity and presence of errors can be displayed by designating the device.

The program searched is the one stored in the current project.

The program cannot be searched by label name.

This screen cannot be used when the operation mode is GX Works 2.

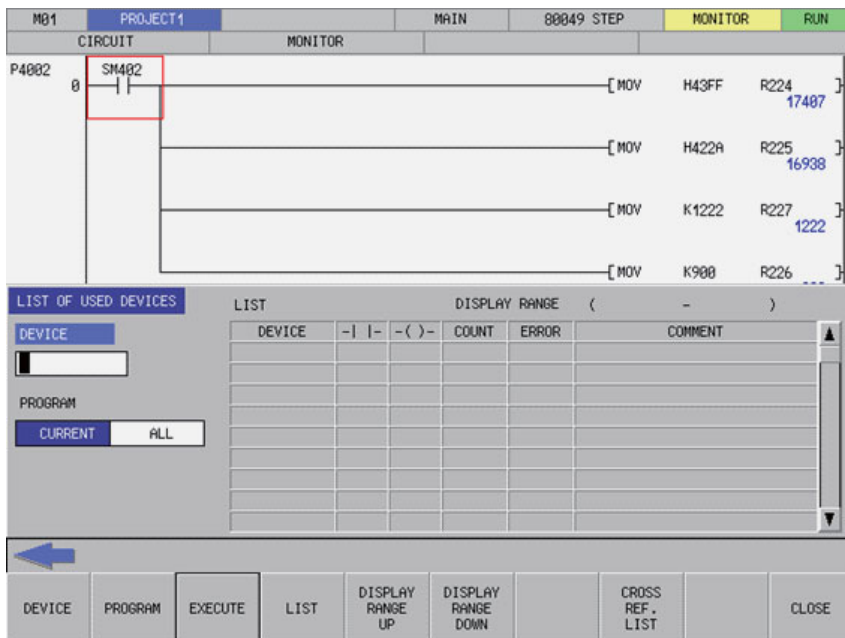

6.15.7.2 Screen Display Items

The following table describes the screen display items for the list of used devices popup screen.

Item name	Display state
Device	This displays the device to be searched.
Program	This displays the currently displayed or all programs.
List	This displays the search results.
Display range	This displays the range of devices displayed in the current list.

6.15.7.3 Enabled/Disabled State of Menu Keys

The menu keys displayed on the list of used devices popup screen are always enabled.

6.15.7.4 Status during Screen Displays

The following table describes the status when displaying the list of used devices popup screen.

Item name	Display state
Device	This displays the device at the cursor position in the ladder screen. This also sets the alias for the device at the cursor position and displays the alias if attempting to display the alias. This is left blank if there is no device at the cursor position. This is the default focus position when the screen is displayed.
Program	This selects the current display.
List	This is left blank.
Display range	The range is not displayed.

6.15.7.5 Operation of Key Presses

The following table describes the operation of each menu key and the keys on the NC keyboard when pressed.

Item name	Operation
Left arrow key	Refer to "6.15.7.7 Closing the List of Used Devices Popup Screen".
Device	This selects the device input field.
Program	This selects the search program selection field or changes the selection of the program to be searched.
Execute	Refer to "6.15.7.6 Investigating Usage States of Devices".
List	This selects the list.
Display range upward	This moves the range of devices displayed in the list upward by one page (128 points).
Display range downward	This moves the range of devices displayed in the list downward by one page (128 points).
Contact Coil Usage List	This displays the contact coil usage list popup screen.
Close	Refer to "6.15.7.7 Closing the List of Used Devices Popup Screen".

6.15.7.6 Investigating Usage States of Devices

Normal operation

■ When devices are used

- (1) Press the [DEVICE] menu key and enter the device for which you want to investigate the usage state.
- (2) Press the [PROGRAM] menu key and select whether the program to be searched is the currently displayed program or the entire program stored in the current project.
- (3) Press the [EXECUTE] menu key to investigate the usage state. The investigation results are displayed in the list.
- (4) Press the [DISPLAY RANGE UPWARD] and [DISPLAY RANGE DOWNWARD] menu keys to transition to the range that includes the devices for which you want to check the results.
- (5) Press the [LIST] menu key to select the list. Use the up/down arrow keys, "PageUp" key, and "PageDown" key to select the area of the status you want to check.
- (6) Press the [CONTACT COIL USAGE LIST] menu key. An investigation is automatically performed to determine the manner in which the device at the cursor position in the list is used and then the contact coil usage list popup screen displays. (Refer to "6.15.6 Contact Coil Usage List Popup Screen")

When aliases are used

Usage states can be investigated using aliases in the same way as for devices by specifying the alias configured for the device into the [DEVICE/INST.] input field. Only aliases configured with single-byte alphanumeric characters can be investigated by the PLC On-board.

Use either of the following formats to specify the alias.

- ♦ "Single quotation mark" + "Desired alias"
- ♦ "Period" + "Desired alias"

Processes other than device specifications are performed in the same way as normal.

Abnormal operation

This information describes the details of error messages displayed on the list of used devices popup screen and the corrective action thereof.

Error message	Error details	Remedy
Device setting is wrong. The following causes may be responsible: ♦ An unusable device has been designated. ♦ Index modification, module specification setting is wrong. ♦ Special function module device, link direct device setting is wrong.	This is displayed when the [EXECUTE] menu key is pressed when the range of the specified device is unusable or a mistake was made in the specification of the index modification, module specification, etc.	Enter a suitable device into the device/instruction input field and then press the [EXECUTE] menu key again.
Device setting is wrong. The following causes may be responsible: ♦ The device No. is over the usable range. ♦ An unusable device has been designated.	This is displayed when the [EXECUTE] menu key is pressed when the range of the specified device is unusable or an unusable device is specified.	Enter a suitable device into the device/instruction input field and then press the [EXECUTE] menu key again.
A device that corresponds to the alias has not been assigned. Check the device comment window.	This is displayed when the [EXECUTE] menu key is pressed after entering an alias not allocated to a device.	Enter an alias allocated to a device and then press the [EXECUTE] menu key again.

6.15.7.7 Closing the List of Used Devices Popup Screen

Use any of the following methods to close the list of used devices popup screen.

Methods to close the screen
Press the [CLOSE] menu key.
Press the left arrow key.
Press the [ESC] key on the software keyboard.

6.15.8 Check Program Popup Screen

6.15.8.1 Outline

This enables checking of logical errors and input mistakes in the program.

The program searched is the one stored in the current project.

This screen cannot be used when the operation mode is GX Works 2.

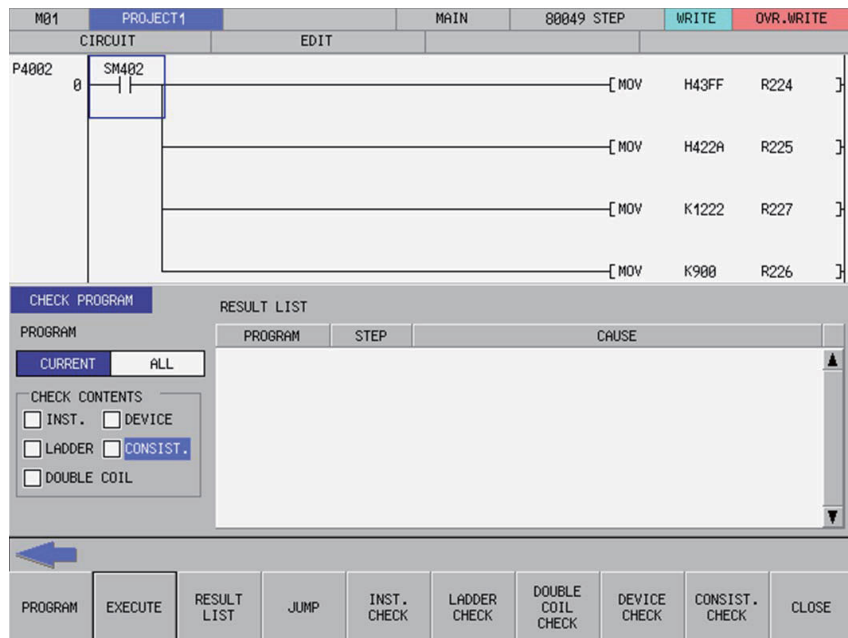

6.15.8.2 Screen Display Items

The following table describes the screen display items for the check program popup screen.

Item name	Display state
Program	This displays the currently displayed or all programs.
Check details	
Instruction	This displays whether or not the instruction check is executed.
Ladder	This displays whether or not the ladder check is executed.
Double coil	This displays whether or not the double coil check is executed.
Device	This displays whether or not the device check is executed.
Consistency	This displays whether or not the consistency check is executed.
Result list	This displays the results of the check program operation.

6.15.8.3 Enabled/Disabled State of Menu Keys

The menu keys displayed on the check program popup screen are always enabled.

6.15.8.4 Status during Screen Displays

The following table describes the screen display items for the check program popup screen.

Item name	Display state
Program	This selects the current display.
Check details	
Instruction	This displays the execution of the instruction check (when applicable).
Ladder	This displays the execution of the ladder check (when applicable).
Double coil	This displays the execution of the double coil check (when applicable).
Device	This displays the execution of the device check (when applicable).
Consistency	This displays the execution of the consistency check (when applicable).
Result list	This is left blank.

6.15.8.5 Operation of Key Presses

The following table describes the operation of each menu key and the keys on the NC keyboard when pressed.

Item name	Operation
Left arrow key	Refer to "6.15.8.7 Closing the Check Program Popup Screen".
Program	This selects the check program selection field or changes the selection of the program to be checked.
Execute	Refer to "6.15.8.6 Checking Programs".
Result list	This selects the result list.
Jump	This moves the cursor on the ladder screen to the step position selected in the list.
Instruction check	This selects the check instruction selection field or changes the selection to execute/not execute the instruction check.
Ladder check	This selects the check ladder selection field or changes the selection to execute/not execute the ladder check.
Double coil check	This selects the check double coil selection field or changes the selection to execute/not execute the double coil check.
Device check	This selects the check device selection field or changes the selection to execute/not execute the device check.
Consistency check	This selects the check consistency selection field or changes the selection to execute/not execute the consistency check.
Close	Refer to "6.15.8.7 Closing the Check Program Popup Screen".

6.15.8.6 Checking Programs

- (1) Press the [CHECK PROGRAM] menu key and select whether the program to be checked is the currently displayed program or the entire program stored in the current project.
- (2) Press the [INST. CHECK] menu key to select whether or not to perform the instruction check.
- (3) Press the [LADDER CHECK] menu key to select whether or not to perform the ladder check.
- (4) Press the [DOUBLE COIL CHECK] menu key to select whether or not to perform the double coil check.
- (5) Press the [DEVICE CHECK] menu key to select whether or not to perform the device check.
- (6) Press the [CONSIST. CHECK] menu key to select whether or not to perform the consistency check.
- (7) Press the [EXECUTE] menu key to start the checks.

A progress bar is displayed indicating the status during the program checks.



- (8) Press the [RESULT LIST] menu key to select the result list. Use the up/down arrow keys, Page Up key, and Page Down key to select the area where errors occurred in the ladder you want to check.
- (9) Press the [JUMP] menu key. Move the cursor on the ladder screen to the program or step position present in the ladder selected in the result list.

[Selecting the entry device monitor]

Transitioning between the ladder screen and the split screen

Use the [SPLIT SCREEN] transition menu key to transition between the ladder screen and the split screen (entry device monitor). Pressing the [SPLIT SCREEN TRANSITION] menu key transitions the selection to the split screen when the ladder screen is selected and transitions the selection to the ladder screen when the split screen is selected.

Registering devices to the entry device monitor

Pressing the [REGISTER MONITOR] menu key registers the device or ladder at the cursor position to the registration monitor in accordance with the following rules.

Status	Operation when the register monitor menu key is pressed
Not using split screen mode	Registers the ladder at the cursor position to the entry ladder monitor.
Displaying the entry ladder monitor	
Displaying the entry device monitor	Registers the device at the cursor position to the entry device monitor.
Selecting the entry device monitor	

6.15.9.2 Entry Ladder Monitor

Outline

This splits the ladder screen (monitor) and enables the registered ladders to be monitored together with the ladder monitor display.

The display of menu keys changes depending on whether the ladder screen or the entry ladder monitor is selected.

[Selecting the ladder screen]

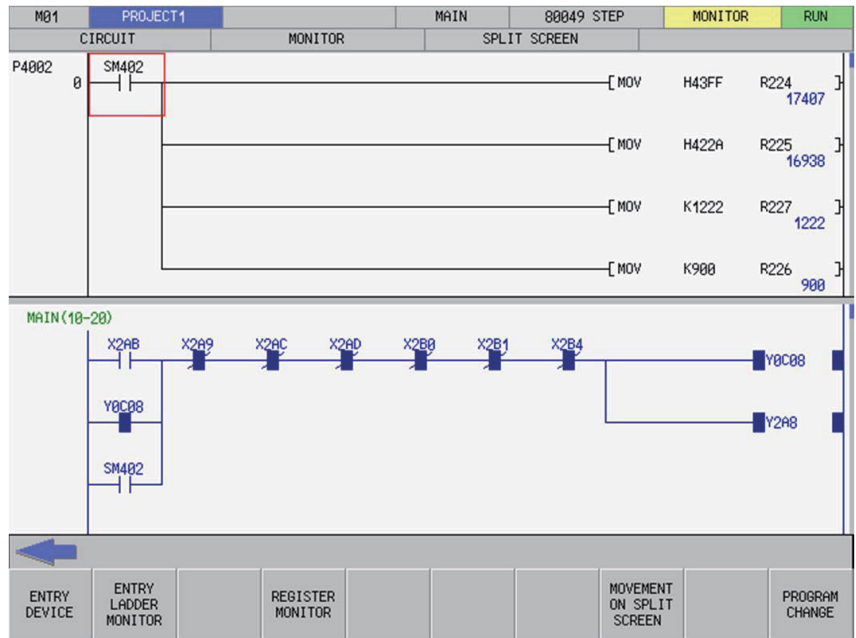

[Selecting the entry ladder monitor]

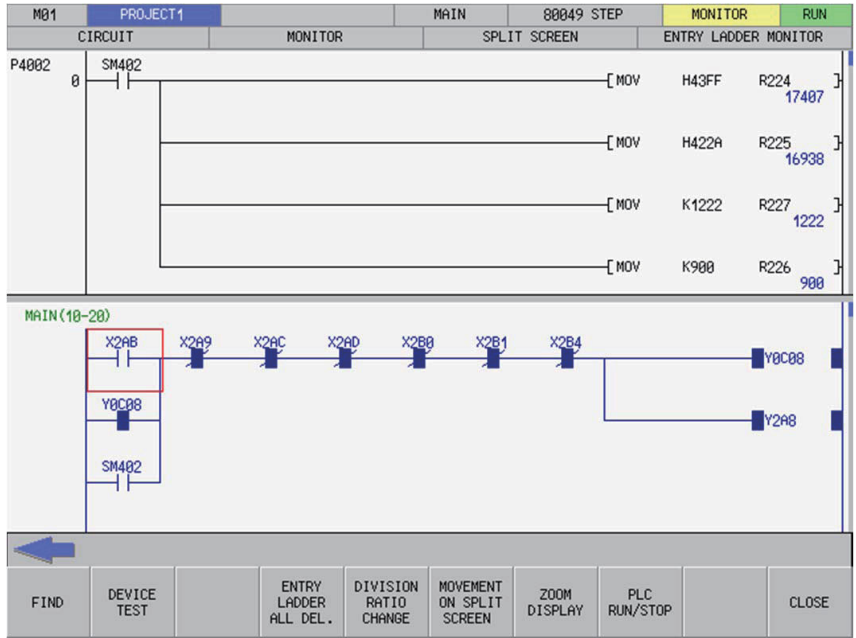

Transitioning between the ladder screen and the split screen

Use the [SPLIT SCREEN] movement menu key to transition between the ladder screen and the split screen (entry ladder monitor). Pressing the [SPLIT SCREEN TRANSITION] menu key transitions the selection to the split screen when the ladder screen is selected and transitions the selection to the ladder screen when the split screen is selected.

Registering ladders to the entry ladder monitor

Pressing the [REGISTER MONITOR] menu key registers the device or ladder at the cursor position to the registration monitor in accordance with the following rules.

Status	Operation when the register monitor menu key is pressed
Not using split screen mode	Registers the ladder at the cursor position to the entry ladder monitor.
Displaying the entry ladder monitor	
Displaying the entry device monitor	Registers the device at the cursor position to the entry device monitor.
Selecting the entry device monitor	

Deleting registered ladders

■ Deleting individual ladder blocks

Perform the following operations in order to delete ladder circuits registered in the entry ladder monitor one block at a time.

- (1) Use the [SPLIT SCREEN TRANSITION] menu key to select the entry ladder monitor.
- (2) Use the keys as described in "6.3.1 Basic Operation Keys" to transition to the left end of the ladder block you want to delete. The background color of the ladder block changes to blue after transitioning to the left end of the ladder block.
- (3) Press the [DELETE] key.

■ Deleting all registered circuits

Perform the following operations in order to delete all ladder circuits registered in the entry ladder monitor.

- (1) Use the [SPLIT SCREEN TRANSITION] menu key to select the entry ladder monitor.
- (2) Press the [DELETE ALL REG. CIRCUITS] menu key. Pressing the [DELETE ALL REG. CIRCUITS] menu key displays the following message.

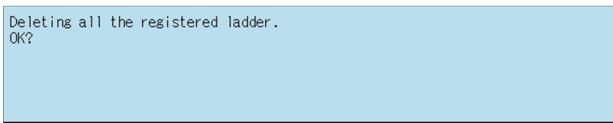

- (3) Pressing the [YES] menu key closes the message screen and all ladder circuits registered in the entry ladder monitor are deleted.
Pressing the [NO] menu key closes the message. The ladder circuits registered in the entry ladder monitor are not deleted.

Changing the split screen ratio for the entry ladder monitor

The split ratio between the display of the "ENTRY LADDER MONITOR" and "CIRCUIT" screens can be changed. When the [DEVISION CHANGE] menu key is pressed, the split ratio changes between "25%" -> "50%" -> "75%" -> "100%" -> "25%". The default split ratio is 50%.

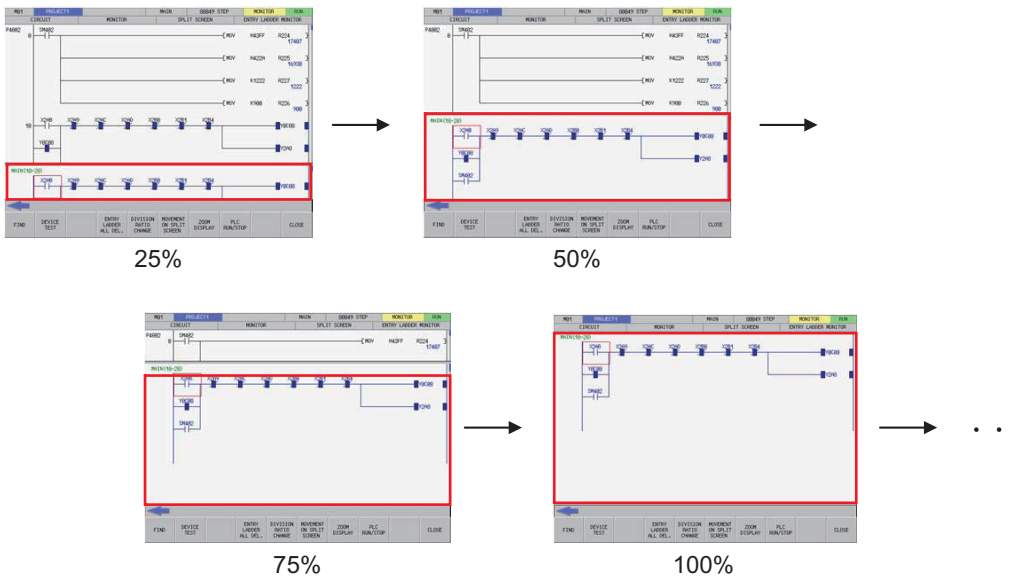

Closing the Entry Ladder Monitor

Use any of the following methods to close the entry ladder monitor popup screen.

Methods to close the screen
Select the entry ladder monitor and press the [CLOSE] menu key.
Select the entry ladder monitor and press the left arrow key.
Select the entry ladder monitor and press the [ESC] key on the soft keyboard.
Select the entry ladder monitor and press the [ENTRY LADDER MONITOR] menu key.

6.15.10 FB Instance Monitor Screen

6.15.10.1 Outline

FB ladders allocated to the program are displayed and FB instance contacts and coil continuity state can be monitored. When searching device in FB is searched with continuous search, the program which uses the FB cannot be found and the monitor is not executed. This displays the ladder monitor screen, not the FB instance monitor screen. FB created in programming language which cannot be displayed is not displayed.

■ When transitioning with [FB Instance Monitor] menu

The screenshot shows the 'FB Instance Monitor' screen. At the top, the status bar indicates 'M01 PROJECT1 FB_1 12 STEP MONITOR RUN'. The main area displays a ladder logic diagram with a normally open contact labeled 'in_bit_123456789' at step 8. A callout box points to this contact with the text: 'The device is displayed and monitored on the FB instance monitor screen.' Below the diagram is a control panel with a menu bar (MONITOR, SET UP, EDIT, DIAGN, MAINT) and a keyboard layout. The 'MONITOR' menu item is highlighted in blue.

■ When searching device in an FB using "continuous search"

The screenshot shows the 'Circuit Monitor' screen. The status bar at the top indicates 'M01 PROJECT1 FB_1 12 STEP MON. STOP(FB) RUN'. The main area displays the same ladder logic diagram as the previous screenshot, with the 'in_bit_123456789' contact at step 8. A callout box points to this contact with the text: 'The device is displayed on the circuit monitor screen, but it is not monitored.' Below the diagram is the same control panel as in the previous screenshot, but the 'MONITOR' menu item is not highlighted.

6.15.10.2 Screen display items

The following table describes the screen display items for the FB instance monitor screen.

Item name	Display state
Connected CNC name	This displays the name of the connected CNC.
Current project No.	This displays the current project number.
Current project label	This displays the project label.
Program name	This displays the name of the currently displayed program.
Step number	This displays the step number of the currently displayed program.
Monitor/Edit display	This displays the [MONITOR].
PLC status and overwrite/insert display	This displays the PLC state (RUN/STOP).
Alarm message	Alarm messages are displayed when alarms occur.
Left arrow key	This is displayed when enabled.
Software keyboard	This is displayed only when parameters are enabled.

6.15.10.3 Enabled/Disabled State of Menu Keys

The menu keys displayed on the FB instance monitor screen are always enabled.

6.15.10.4 Operation of Key Presses

Item name	Display state
Left arrow key	This closes the displayed FB instance monitor screen.
Find	This displays the find popup screen. (Refer to "6.15.3 Find Popup Screen")
Find Step No.	This opens the Find Step No. popup screen. (Refer to "6.15.4 Find Step No. Popup Screen")
Device Test	This displays the device test popup screen. (Refer to "6.15.5 Device Test Popup Screen")
FB Instance Monitor	This displays the FB instance monitor.
Current value monitor changeover (10/16)	This changes the currently monitored value display between decimal and hexadecimal.
PLC RUN/STOP	Display the PLC RUN/STOP popup screen.
Comment ON/OFF	This turns the device comment display ON and OFF.
ZOOM DISPLAY	This changes the display magnification of the ladder screen.
BACK	This returns to the source "Ladder monitor" screen or "FB instance monitor" screen.

6.15.10.5 Start FB Instance Monitor

FB instance monitor automatically starts by transitioning to FB instance monitor screen. The following procedures describe how to transit to FB instance monitor screen.

Normal operation

- (1) Put the cursor to the FB on the ladder monitor screen.
- (2) Press the [FB Instance Monitor] key or the [INPUT] key.

When touch gestures are available, transitioning can be executed by double-tapping FB.

When block password is set to FB, block password disable screen is displayed. Refer to "6.15.11 Block Password Disable screen" for details.

Abnormal operation

Error message	Error details	Remedy
FB is not selected at the cursor position.	This is displayed when the [FB Instance Monitor] menu is pressed without FB at a cursor position.	Press the [FB Instance Monitor] menu with FB selected at a cursor position.
The FB is created in a programming language which cannot be displayed.	This is displayed when [FB Instance Monitor] menu is pressed after selecting FB created in a programming language which cannot be displayed	Confirm the content of the FB with GX Developer/GX Works2.

6.15.10.6 Close FB Instance Monitor

Use any of the following methods to close the FB instance monitor screen.

Methods to close the screen
Press the [BACK] menu.
Press the left arrow key.
Press the [ESC] key on the software keyboard.

6.15.11 Block Password Disable screen

6.15.11.1 Outline

On this screen, block password set to project POU is disabled.

Refer to "6.6.3.2 Block Passwords for PLC Data" for block password specifications.

■ Block password disable screen

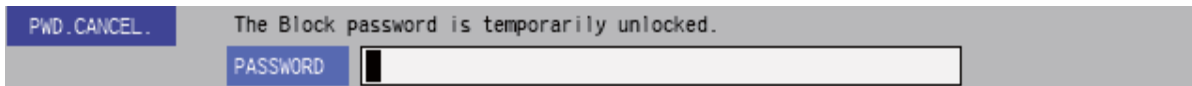

6.15.11.2 Screen display items

Item name	Operation
Password	Enter the password. Passwords are displayed as "***". Input range: 6 to 32 characters Refer to "6.6.3 Passwords for PLC Data" for the characters that can be input.

6.15.11.3 Enabled/Disabled State of Menu Keys

The menu keys displayed on the block password disable screen are always enabled.

6.15.11.4 Operation of Key Presses

Item name	Operation
Left arrow key	This closes the block password disable screen.
Execute	Refer to "6.15.11.5 Canceling Block Password"
CLOSE	This closes the block password disable screen.

6.15.11.5 Canceling Block Password

Normal operation

- (1) Enter the set password.
- (2) Press the [EXECUTE] menu.

Pressing the menu key closes the block password disable screen and continues with the original process.

Abnormal operation

This following describes the details of error messages displayed when entering passwords and pressing the [EXECUTE] menu key and the corrective action.

Error message	Error details	Remedy
The entered password is not correct. Enter correct password.	This is displayed when the [EXECUTE] menu key is pressed after entering an incorrect password.	Enter the password before pressing the [EXECUTE] menu key.

6.15.11.6 Block Password Disable Screen

Use any of the following methods to close the block password disable screen.

Methods to close the screen
Press the [CLOSE] menu.
Press the left arrow key.
Press the [ESC] key on the software keyboard.

6.15.12 Switching Programs

6.15.12.1 Outline

The programs displayed on the ladder screen can be changed.

The programs that can be selected differ depending on whether selecting to switch programs while monitoring ladders or while editing ladders.

When the program is created in a program language which cannot be displayed, it is not displayed in a selection.

[Monitoring ladders]

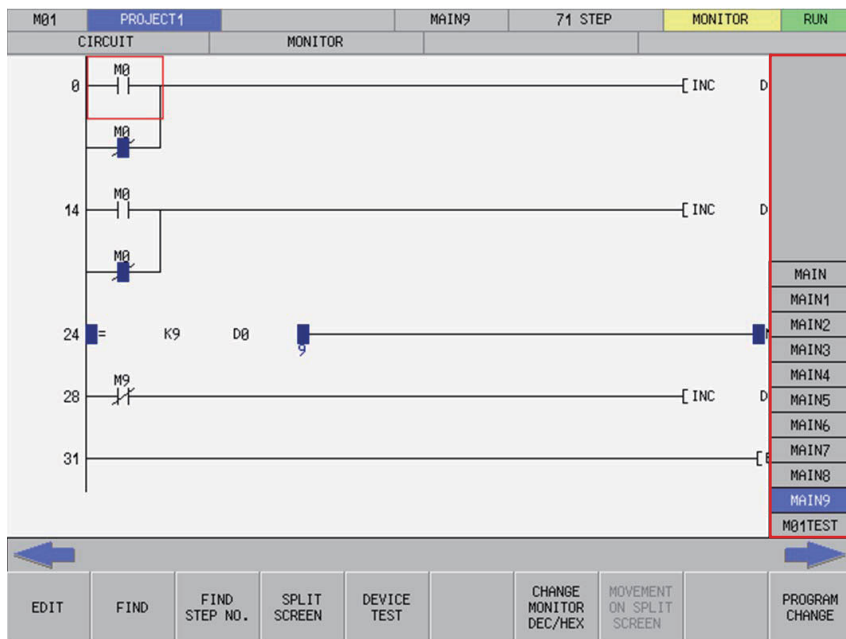

[Editing ladders]

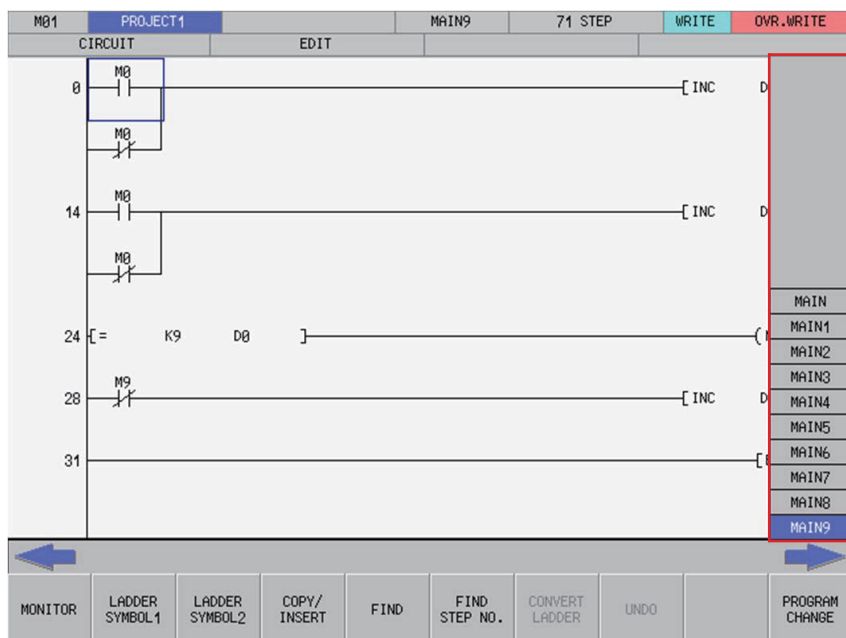

6.15.12.2 Selecting and Switching Programs

Refer to "Switching between programs or other types of data" under "Setting selection items in lists" in "6.3.2 Screen Items (Control)" to select and switch programs.

Switching programs while monitoring ladders enables you to switch between programs and PLC messages.

Switching programs while editing ladders enables you to switch programs only.

Note that the following message screen displays when attempting to switch programs when there are unconverted ladders.

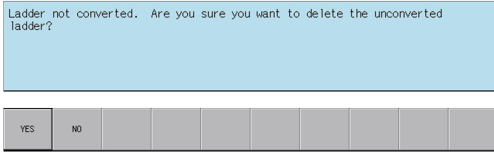

Pressing the [YES] menu key cancels the unconverted ladder and switches to the program selected on the switch program screen.

Pressing the [NO] menu key returns to the ladder screen without switching to the program selected on the switch program screen.

6.15.12.3 Block Password Disable

A program name of a program block with block password begins with "*" and Block Password Disable screen is displayed when selected.

Refer to "6.15.11 Block Password Disable screen" for details of clearing block passwords.

[Block Password Disable screen]

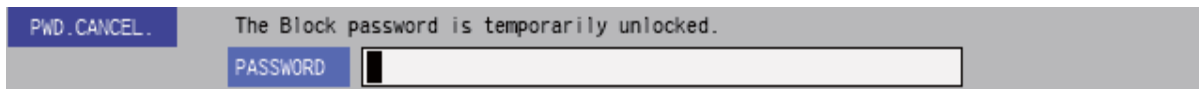

[Switch Program (with block password)]

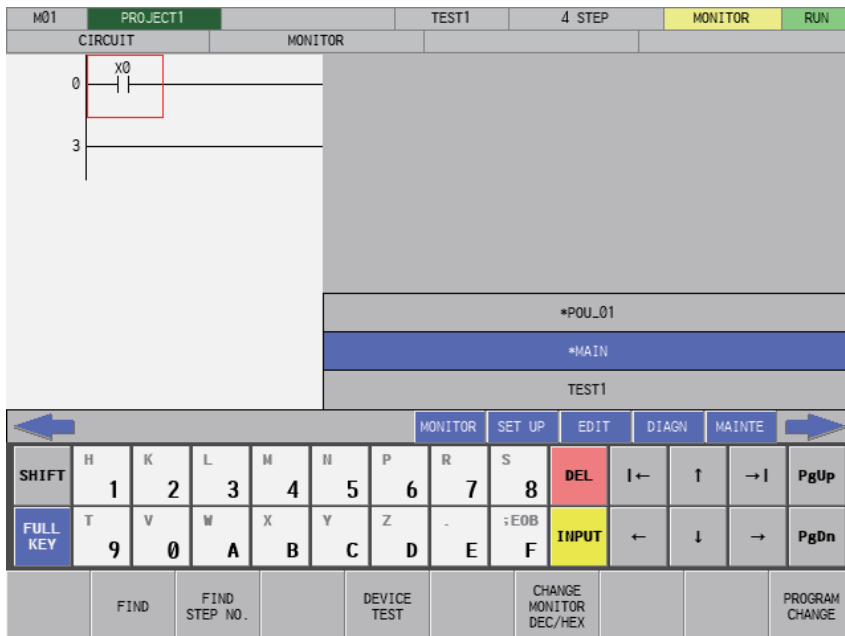

6.16 Environment Setting Menus

6.16.1 Environment Settings Main Screen

6.16.1.1 Outline

This section describes the various settings for using the PLC On-board.

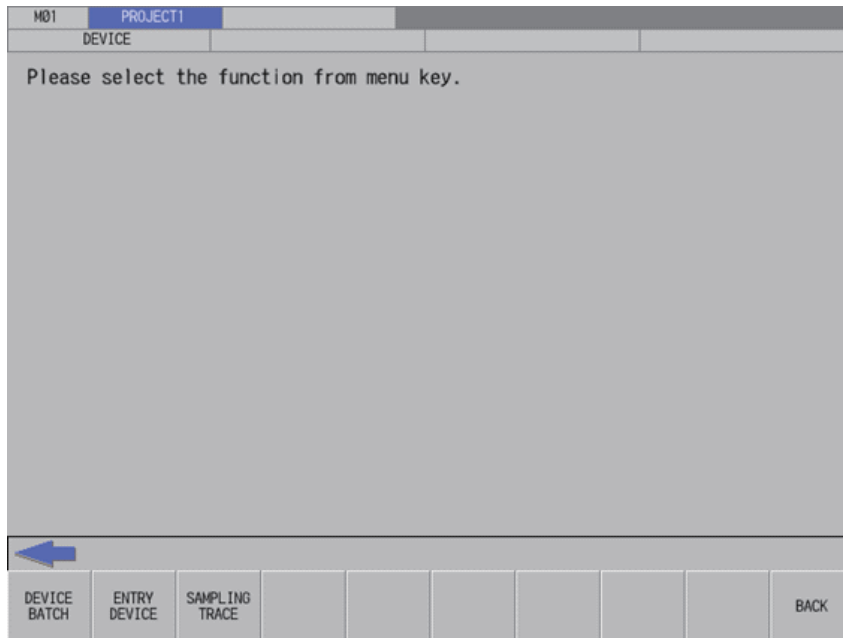

6.16.1.2 Screen Display Items

The following table describes the screen display items for the environment settings screen.

Item name	Display state
Connected NC name	This displays the name of the connected NC.
Current project No.	This displays the current project number.
Current project label	This displays the project label.
Alarm message	Alarm messages are displayed when alarms occur.
Left arrow key	This is displayed when enabled.
Software keyboard	This is displayed only when parameters are enabled.

6.16.1.3 Enabled/Disabled State of Menu Keys

The following table describes the conditions upon which menu keys displayed on the environment settings screen are enabled/disabled.

The menu keys which are not described in the following table are always enabled.

Menu name	Condition upon which it is enabled/disabled
Comment Display Setting	This is enabled when reading the sequence program in the current project.
Ladder Display	This is enabled when reading the sequence program in the current project.
GXWorks2 Setting	Enabled in GX Works2 mode.

6.16.1.4 Operation of Key Presses

The following table describes the operation of each menu key and the keys on the NC keyboard when pressed.

Item name	Operation
Left arrow key/return menu key	These transition to the main menu.
Various menu keys	This displays the specified screen.

6.16.2 Comment Display Settings Screen

6.16.2.1 Outline

This configures settings for device comments stored in projects.

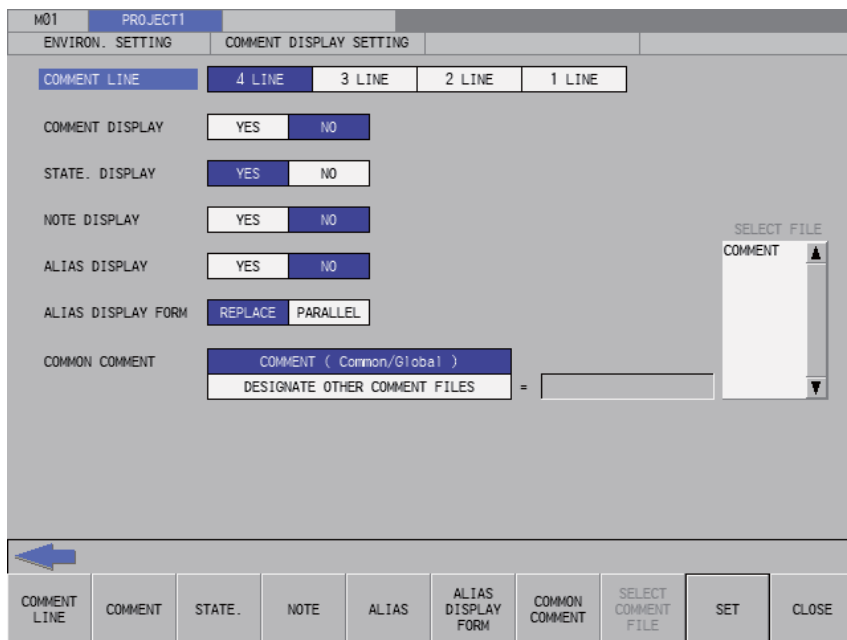

6.16.2.2 Screen Display Items

The following table describes the screen display items for the comment display settings screen.

Item name	Display state
Connected NC name	This displays the name of the connected NC.
Current project No.	This displays the current project number.
Current project label	This displays the project label.
Alarm message	This is displayed when alarms occur.
Left arrow key	This is displayed when enabled.
Software keyboard	This is displayed only when parameters are enabled.
Comment line	This displays the [4 LINE], [3 LINE], [2 LINE], and [1 LINE] options.
Comment display	This displays the [YES] and [NO] options.
Statement display	
Note display	
Alias display(*1)	
Alias display form(*1)	This displays the [REPLACE] and [PARALLEL] options.
Common comment file	This displays the [COMMENT (Common/Global)] and [Specify other comment file].
Select comment file	This displays the name of the device comment file stored in the current project.

(*1) The settings of "Alias display" and "Alias display form" have no affect on the device comment in GX Works2 mode.

6.16.2.3 Enabled/Disabled State of Menu Keys

The following table describes the conditions upon which menu keys displayed on the comment display settings screen are enabled/disabled.

The menu keys which are not described in the following table are always enabled.

Menu name	Condition upon which it is enabled/disabled
Common comment file	This is enabled when device comments are stored in the current project.
Select comment file	This is enabled when device comments are stored in the current project and the selection of the common comment file is [[DESIGNATE OTHER COMMENT FILES].

6.16.2.4 Status during Screen Displays

The following table describes the status when displaying the comment display settings screen for the first time.

(The details of the configuration made on the comment display settings screen are stored. The screen is displayed with the updated settings configured previously the next time it is displayed. However, the comment file name displayed in the select comment file field is updated every time the screen is displayed.)

Item name	Operation
Comment line	This selects the [4 LINE] option.
Comment display	This selects the [NO] option.
Statement display	This selects the [NO] option.
Note display	This selects the [NO] option.
Alias display	This selects the [NO] option.
Alias display form	This selects the [REPLACE] option.
Common comment file	Select "COMMENT (Common/Global)".
Select comment file	This displays the name of the device comment file stored in the current project.

6.16.2.5 Operation of Key Presses

The following table describes the operation of each menu key and the keys on the NC keyboard when pressed.

Item name	Operation
Left arrow key	Refer to "6.16.2.8 Closing the Comment Display Settings Screen".
Comment line	This sets the focus to the comment line. This changes the comment line selection when the focus is already set.
Comment display	This sets the focus to the comment display. This changes the comment display selection when the focus is already set.
Statement display	This sets the focus to the statement display. This changes the statement display selection when the focus is already set.
Note display	This sets the focus to the note display. This changes the note display selection when the focus is already set.
Alias display	This sets the focus to the alias display. This changes the alias display selection when the focus is already set.
Alias display form	This sets the focus to the alias display form. This changes the alias display form selection when the focus is already set.
Common comment file	This sets the focus to the common comment file. This changes the common comment file selection when the focus is already set.
Select comment file	This sets the focus to the select comment file.
Settings	Refer to "6.16.2.7 Setting the Comment Display State".
Close	Refer to "6.16.2.8 Closing the Comment Display Settings Screen".

6.16.2.6 Common Comment File

COMMENT (Common/Global)

When [COMMENT (Common/Global)] is selected as the common comment file, a correspondence is created between the sequence program and device comments as illustrated in the following diagram.

[Contains only common/global comments]

Common/Global comment are referenced in all sequence programs.

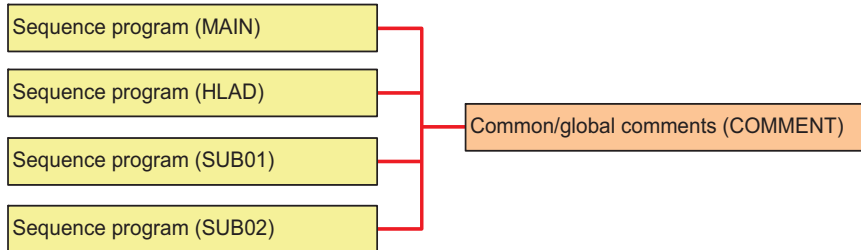

[Contains both common/global comments and program-specific/local comments]

Program-specific / local comments are only referenced in sequence programs with the same name. Common / global comments are referenced in the other sequence programs.

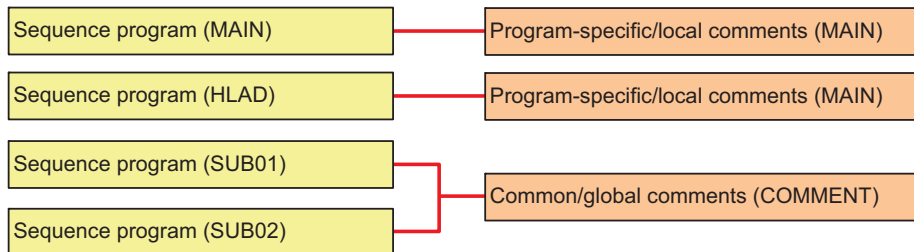

Specifying other comment files

When [Specify other comment file] is selected as the common comment file, you can specify one comment file referenced by all sequence programs.

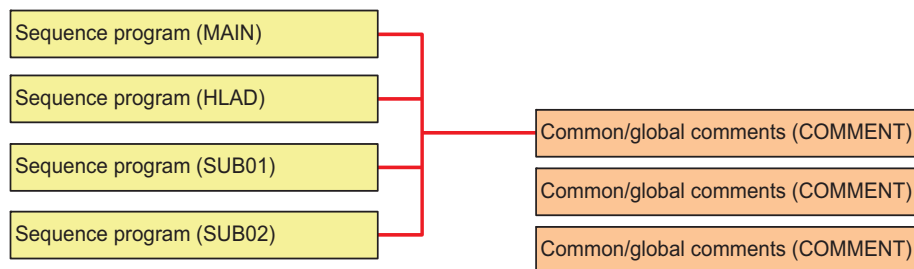

6.16.2.7 Setting the Comment Display State

- (1) Press the [COMMENT LINE] menu key and select the number of comment lines to display on the ladder screen.
- (2) Press the [COMMENT DISPLAY] menu key and select whether or not to display comments on the ladder screen.
- (3) Press the [STATE. DISPLAY] menu key and select whether or not to display statements on the ladder screen.
- (4) Press the [NOTE DISPLAY] menu key and select whether or not to display notes on the ladder screen.
- (5) Press the [ALIAS DISPLAY] menu key and select whether or not to display aliases on the ladder screen.
- (6) Press the [ALIAS DISPLAY FORM] menu key and select whether to replace the format of the alias display with the device name or to display both the alias and device name vertically in parallel.
- (7) Press the [COMMON COMMENT] menu key and select whether to use COMMENT (Common/ Global) common comments or to specify some other comment file.
- (8) Perform this step only when [Specify other comment file] was selected at step (7).
 - (a) Press the [SELECT COMMENT FILE] menu key and select the select comment file field.
 - (b) Press the up and down arrow keys and select the comment file to use as the common comment file.
 - (c) Press the [INPUT] key and issue the common comment file selection.
- (9) Press the [SET] menu key and issue the comment display configuration.
Pressing the [SET] menu key also closes the comment display settings screen and returns to the environment settings screen.

Note

- (1) The comment display settings are retained even after the power OFF. When restarting after the power OFF, the displayed comment on the ladder screen is based on the retained contents.
- (2) Specifications differ between device comments of the project created with GX Developer and GX Works2. GX Works2 project can have device comment in bit units of word device. Display of word device comment when used in bit units differs between GX Developer and GX Works2.

[GX Developer]
Device comments set in word devices are also displayed in word devices used in bit units.

[GX Works2]
Device comments set in word devices are displayed in word device used as word devices. Device comments set in bit units are displayed in word devices used in bit units.

6.16.2.8 Closing the Comment Display Settings Screen

Use any of the following methods to close the comment display settings screen.

Methods to close the screen
Press the [SET] menu key.
Press the [CLOSE] menu key.
Press the left arrow key.
Press the [ESC] key on the software keyboard.

6.16.3 Ladder Display Settings Screen

6.16.3.1 Outline

This configures settings for the ladder screen. These settings are common between different projects.

The screenshot shows a software interface for configuring ladder display settings. At the top, it displays 'M01 PROJECT1'. Below this, there are two tabs: 'ENVIRON. SETTING' and 'LADDER DISPLAY'. The 'LADDER DISPLAY' tab is active. Under this tab, there are three main settings sections:

- NUMBER OF CONTACT:** A row of five buttons labeled '21 CONTACTS', '17 CONTACTS', '13 CONTACTS', '11 CONTACTS', and '9 CONTACTS'. The '11 CONTACTS' button is highlighted in blue.
- ZOOM DISPLAY:** A row of three buttons labeled 'REDUCTION', 'STANDARD', and 'EXPANSION'. The 'STANDARD' button is highlighted in blue.
- MONITOR VALUE DISPLAY:** A row of two buttons labeled 'YES' and 'NO'. The 'YES' button is highlighted in blue.

At the bottom of the screen, there is a navigation bar with several buttons: 'NUMBER OF CONTACT', 'ZOOM DISPLAY', 'MONITOR VALUE DISPLAY', 'SET', and 'CLOSE'. A blue arrow points to the left from the 'NUMBER OF CONTACT' button.

6.16.3.2 Screen Display Items

The following table describes the screen display items for the ladder display settings screen.

Item name	Display state
Connected NC name	This displays the name of the connected NC.
Current project No.	This displays the current project number.
Current project label	This displays the project label.
Alarm message	This is displayed when alarms occur.
Left arrow key	This is displayed when enabled.
Software keyboard	This is displayed only when parameters are enabled.
Maximum number of contacts	This displays the [21 CONTACTS], [17 CONTACTS], [13 CONTACTS], [11 CONTACTS], and [9 CONTACTS] options.
Zoom display	This displays the [REDUCTION], [STANDARD], and [EXPANSION] options.
Monitor value display	This displays the [YES] and [NO] options.

6.16.3.3 Enabled/Disabled State of Menu Keys

The following table describes the conditions upon which menu keys displayed on the ladder display settings screen are enabled/disabled.

The menu keys which are not described in the following table are always enabled.

Menu name	Condition upon which it is enabled/disabled
Maximum number of contacts	[21 CONTACTS], [17 CONTACTS], and [13 CONTACTS] are disabled in GX Developer mode.
Zoom display	Enabled when the screen resolution is 640 x 480

6.16.3.4 Status during Screen Displays

The following table describes the status when displaying the ladder display settings screen for the first time.

(The details of the configuration made on the comment display settings screen are stored. The screen is displayed with the updated settings configured previously the next time it is displayed.)

Item name	Operation
Maximum number of contacts	This selects the [11 CONTACTS] option.
Zoom display	This selects the [STANDARD] option.
Monitor value display	This selects the [YES] option.

6.16.3.5 Operation of Key Presses

The following table describes the operation of each menu key and the keys on the NC keyboard when pressed.

Item name	Operation
Left arrow key	Refer to "6.16.3.7 Closing the Ladder Display Settings Screen".
Maximum number of contacts	This sets the focus to the number of contacts. This changes the number of contacts selection when the focus is already set.
Zoom display	This sets the focus to the zoom display. This changes the zoom display selection when the focus is already set.
Monitor value display	This sets the focus to the monitor value display. This changes the monitor value display form selection when the focus is already set.
Settings	Refer to "6.16.3.6 Setting the Ladder Display State".
Close	Refer to "6.16.3.7 Closing the Ladder Display Settings Screen".

6.16.3.6 Setting the Ladder Display State

- (1) Press the [NUMBER OF CONTACT] menu key and select either [21 CONTACTS], [17 CONTACTS], [13 CONTACTS], or [9 CONTACTS] for the number of contacts to be displayed on the ladder screen.
 - (2) Press the [ZOOM DISPLAY] menu key and select [REDUCE], [STANDARD], or [ENLARGE] for the magnification of the ladder screen.
 - (3) Press the [MONITOR VALUE DISPLAY] menu key and select wither or not to display the current value on the ladder monitor.
 - (4) Press the [SET] menu key and issue the ladder display configuration.
Pressing the [SET] menu key also closes the ladder display settings screen and returns to the environment settings screen.
- (*1) [21 CONTACTS], [17 CONTACTS], and [13 CONTACTS] cannot be selected in GX Developer mode.

The following table describes the relationship between the screen resolution and the zoom level of the ladder screen.

Screen resolution	Maximum number of contacts	Reduced display	Standard screen	Expanded display
VGA (640 x 480)	21 contacts	Horizontal scroll appears	Horizontal scroll appears	Horizontal scroll appears
	17 contacts	Horizontal scroll appears	Horizontal scroll appears	Horizontal scroll appears
	13 contacts	Horizontal scroll appears	Horizontal scroll appears	Horizontal scroll appears
	11 contacts	Entire ladder can be displayed	Horizontal scroll appears	Horizontal scroll appears
	9 contacts	Entire ladder can be displayed	Entire ladder can be displayed	Horizontal scroll appears
XGA (1024 x 768)	21 contacts		Horizontal scroll appears	
	17 contacts		Horizontal scroll appears	
	13 contacts		Horizontal scroll appears	
	11 contacts		Entire ladder can be displayed	
	9 contacts		Entire ladder can be displayed	
SXGA (1280 x 1024)	21 contacts			Horizontal scroll appears
	17 contacts			Horizontal scroll appears
	13 contacts			Horizontal scroll appears
	11 contacts			Entire ladder can be displayed
	9 contacts			Entire ladder can be displayed

6.16.3.7 Closing the Ladder Display Settings Screen

Use any of the following methods to close the ladder display settings screen.

Methods to close the screen
Press the [SET] menu key.
Press the [CLOSE] menu key.
Press the left arrow key.
Press the [ESC] key on the software keyboard.

6.16.4 GX Works2 Setting Screen

6.16.4.1 Outline

Configure GX Works2 mode setting.

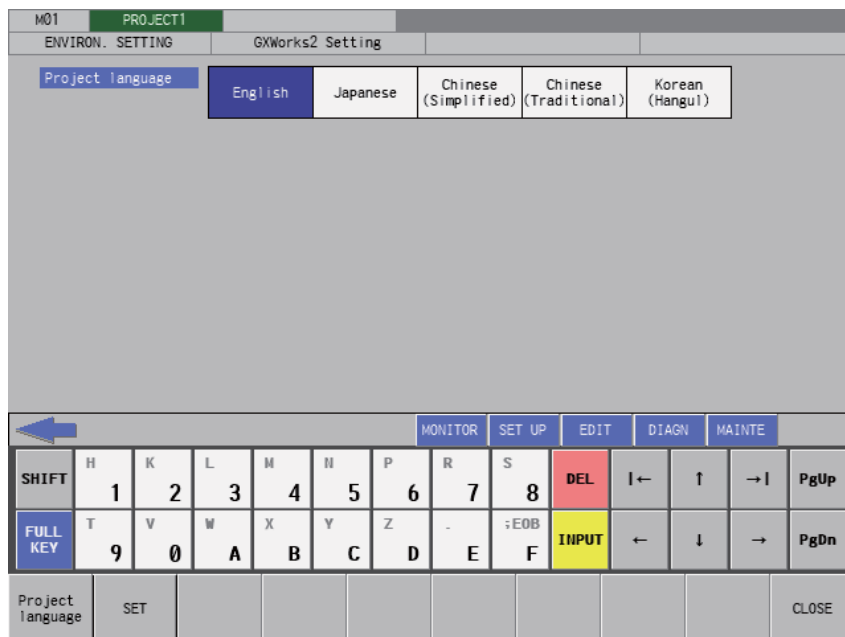

6.16.4.2 Screen Display Items

The following table describes the screen display items for the GX Works2 settings screen.

Item name	Display state
Connected CNC name	This displays the name of the connected CNC.
Current project No.	This displays the current project number.
Current project label	This displays the project label.
Alarm message	Alarm messages are displayed when alarms occur.
Left arrow key	This is displayed when enabled.
Software keyboard	This is displayed only when parameters are enabled.
Project language	"English", "Japanese", "Chinese (Simplified)", "Chinese (Traditional)", and "Korean (Hangul)" are displayed.

6.16.4.3 Enabled/Disabled State of Menu Keys

The menu keys displayed on GX Works2 settings screen are always enabled.

6.16.4.4 Status during Screen Displays

The following table describes the status when displaying the GX Works2 settings screen for the first time.

(The details of the configuration made on the GX Works2 settings screen are stored. The screen is displayed with the updated settings configured previously the next time it is displayed.)

Item name	Operation
Project language	This selects [English].

6.16.4.5 Operation of Key Presses

The following table describes the operation of each menu key and the keys on the CNC keyboard when pressed.

Item name	Operation
Left arrow key	Refer to "6.16.4.7 Closing GX Works2 Settings Screen".
Project language	This sets the focus to the project language. This changes the selection of project language when the focus is already set.
Settings	Refer to "6.16.4.6 Setting Project Language".
CLOSE	Refer to "6.16.4.7 Closing GX Works2 Settings Screen".

6.16.4.6 Setting Project Language

- (1) Press the [Project language] menu key and select one of the following GX Works2 project language(*1): "English", "Japanese", "Chinese (Simplified)", "Chinese (Traditional)", "Korean (Hangul)".
 - (2) Press the [SET] menu key and issue the GX Works2 configuration.
Pressing the [SET] menu key closes the GX Works2 settings screen and returns to the environment settings screen.
- (*1) Refer to "6.5.3 Precautions for Language Setting for GX Works2 Project" for details.

6.16.4.7 Closing GX Works2 Settings Screen

Use any of the following methods to close GX Works2 settings screen.

Methods to close the screen
Press the [SET] menu key.
Press the [CLOSE] menu key.
Press the left arrow key.
Press the [ESC] key on the software keyboard.

6.16.5 Change NC Connection Screen

6.16.5.1 Outline

When the NC display unit and the NC control unit are connected in a ratio of one display unit to multiple NC control units, the NC unit connected with the PLC On-board can be selected. (At the initial start-up of the PLC On-board, the system connects to the same NC unit as the HMI screen side.)

Note

- (1) When switching to another connected NC (control unit), the following information will be discarded.
 - All PLC data in the on-board editing area will be discarded. (Program data with unconverted ladders will also be discarded.)

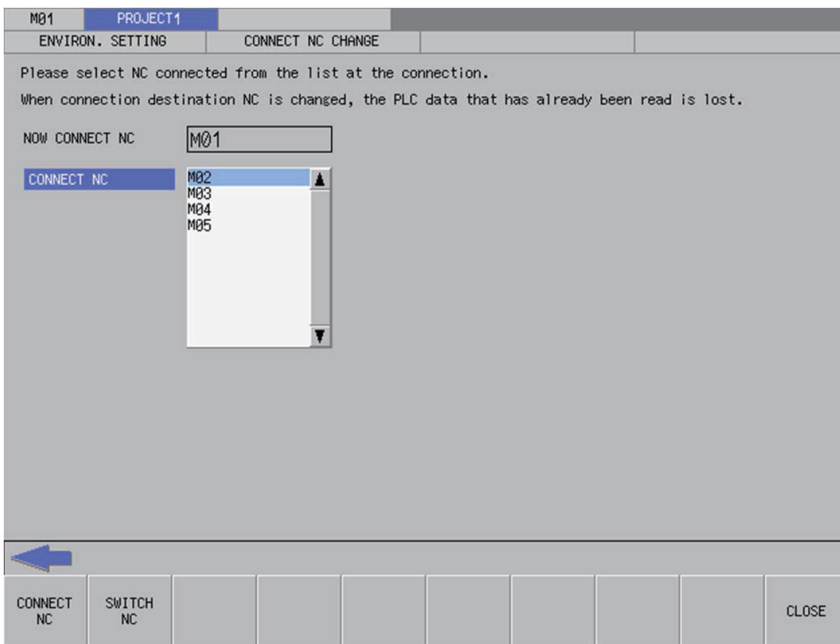
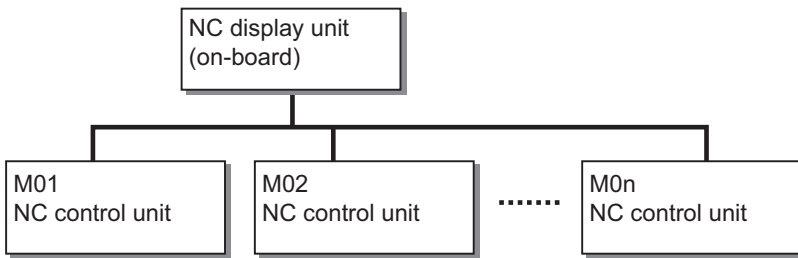

6.16.5.2 Screen Display Items

The following table describes the screen display items for the change NC connection screen.

Item name	Display state
Connected NC name	This displays the name of the connected NC.
Current project No.	This displays the current project number.
Current project label	This displays the project label.
Alarm message	This is displayed when alarms occur.
Left arrow button	This is displayed when enabled.
Software keyboard	This is displayed only when parameters are enabled.
Currently connected NC	This displays the name of the currently connected NC.
Available NCs	This displays the names of NCs available for connection.

6.16.5.3 Enabled/Disabled State of Menu Keys

The following table describes the conditions upon which menu keys displayed on the change connected NC screen are enabled/disabled.

The menu keys which are not described in the following table are always enabled.

Menu name	Condition upon which it is enabled/disabled
Switch NC	Enabled when NCs other than the currently connected NC are not displayed for the available NCs.

6.16.5.4 Status during Screen Displays

The following table describes the status when displaying the change NC connection screen.

Item name	Operation
Currently connected NC	This displays the name of the currently connected NC.
Available NCs	This displays the names of NCs available for connection.

6.16.5.5 Operation of Key Presses

The following table describes the operation of each menu key and the keys on the NC keyboard when pressed.

Item name	Operation
Left arrow key	Refer to "6.16.5.7 Closing the Change NC Connection Screen".
Available NCs	This selects the available NCs.
Switch NC	Refer to "6.16.5.6 Changing the NC Connection".
Close	Refer to "6.16.5.7 Closing the Change NC Connection Screen".

6.16.5.6 Changing the NC Connection

- (1) Press the [AVAILABLE NCS] menu key to select the available NCs screen.
- (2) Use the up/down arrow keys, Page Up key, and Page Down key to select the name of the NC connection.
- (3) Pressing the [SWITCH NC] menu key closes the change NC connection screen and changes the NC connection.

The system transitions to the main screen when changing NC connections so as to read PLC data stored in the newly connected NC.

6.16.5.7 Closing the Change NC Connection Screen

Use any of the following methods to close the change NC connection screen.

Methods to close the screen
Press the [SWITCH NC] menu key.
Press the [CLOSE] menu key.
Press the left arrow key.
Press the [ESC] key on the software keyboard.

6.17 Device Menus

6.17.1 Device Main Screen

6.17.1.1 Outline

This screen contains menus used to monitor devices.

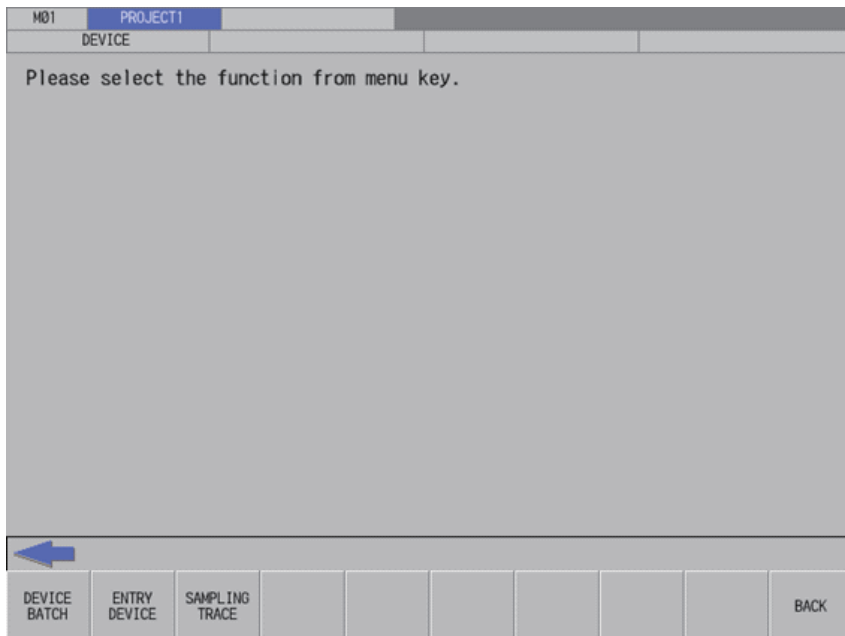

6.17.1.2 Screen Display Items

The following table describes the screen display items on the device main screen.

Item name	Display state
Connected NC name	This displays the name of the connected NC.
Current project No.	This displays the current project number.
Current project label	This displays the project label.
Alarm message	Alarm messages are displayed when alarms occur.
Left arrow key	This is displayed when enabled.
Software keyboard	This is displayed only when parameters are enabled.

6.17.1.3 Enabled/Disabled State of Menu Keys

The following table describes the conditions upon which menu keys displayed on the device main screen are enabled/disabled.

The menu keys which are not described in the following table are always enabled.

Menu name	Condition upon which it is enabled/disabled
Sampling trace	Disabled when the function is restricted.

6.17.1.4 Operation of Key Presses

The following table describes the operation of each menu key and the keys on the NC keyboard when pressed.

Item name	Operation
Left arrow key/return menu key	These transition to the main menu.
Various menu keys	This displays the specified screen.

6.17.2 Device Batch Monitor Screen

6.17.2.1 Outline

This enables multiple consecutive devices to be monitored simultaneously in list format after designating one type of device. The program cannot be searched by label name.

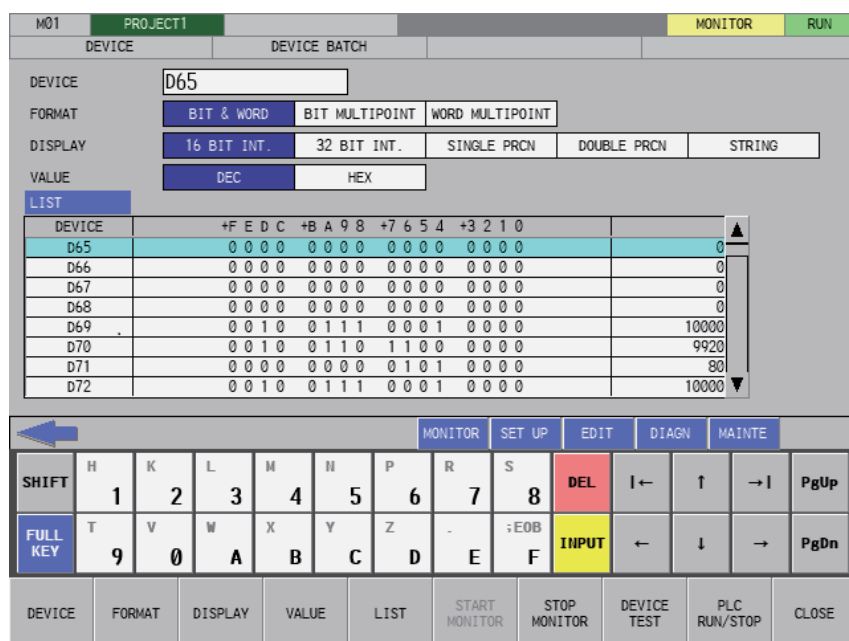

6.17.2.2 Screen Display Items

The following table describes the screen display items on the device batch monitor screen.

Item name	Display state
Connected NC name	This displays the name of the connected NC.
Current project No.	This displays the current project number.
Current project label	This displays the project label.
Monitor/Edit display	Starting the monitor displays "MONITOR". Stopping the monitor cancels the display.
PLC status and overwrite/insert display	This displays the PLC status (RUN/STOP) for the monitored project.
Alarm message	Alarm messages are displayed when alarms occur.
Left arrow key	This is displayed when enabled.
Software keyboard	This is displayed only when parameters are enabled.
Device	This displays the device to be monitored.
Format	This displays the [BIT & WORD], [BIT MULTIPOINT], and [WORD MULTIPOINT] options.
Display	This displays the [16 BIT INT.], [32 BIT INT.], [SINGLE PRCN], [DOUBLE PRCN] and [STRING] options.
Format	This displays the [DEC] and [HEX] options.
List	This displays the monitoring results.

6.17.2.3 Enabled/Disabled State of Menu Keys

The following table describes the conditions upon which menu keys displayed on the device batch monitor screen are enabled/disabled.

The menu keys which are not described in the following table are always enabled.

Menu name	Condition upon which it is enabled/disabled
Start monitor	Disabled after the monitor is started
Stop monitor	Disables after the monitor is stopped

6.17.2.4 Status during Screen Displays

The following table describes the status when displaying the device batch monitor screen.

Item name	Operation
Device	This is left blank.
Format	This selects the [BIT & WORD] option.
Display	This selects the [16 BIT INTEGER] option.
Format	This selects the [DEC] option.
List	This is left blank.

6.17.2.5 Operation of Key Presses

The following table describes the operation of each menu key and the keys on the NC keyboard when pressed.

Item name	Operation
Left arrow key	Refer to "6.17.2.7 Closing the Device Batch Monitor Screen".
Device	This selects the device input field.
Format	This sets the focus to the format. This changes the format selection when the focus is already set.
Display	This sets the focus to the display selection field. This changes the selection in the display selection field when the focus is already set.
Format	This sets the focus to the value selection field. This changes the selection in the value selection field when the focus is already set.
List	The focus is applied to the list.
Start monitor	Refer to "6.17.2.6 Starting and Stopping the Monitor for the Selected Device".
Stop monitor	Refer to "6.17.2.6 Starting and Stopping the Monitor for the Selected Device".
Device test	This displays the device test popup screen. Refer to "6.15.5 Device Test Popup Screen".
PLC RUN/STOP	This displays the PLC RUN/STOP screen. Refer to "6.13.10 PLC RUN/STOP Popup Screen".
Close	Refer to "6.17.2.7 Closing the Device Batch Monitor Screen".

6.17.2.6 Starting and Stopping the Monitor for the Selected Device

Starting the monitor

- (1) Press the [DEVICE] menu key and enter the device you want to monitor into the device selection field.
- (2) Press the [FORMAT] menu key and select the format from the format selection field.
- (3) Press the [DISPLAY] menu key and select the display format for the current value from the display selection field.
- (4) Press the [VALUE] menu key and select the type of value to display for the current value from the value section field.
- (5) Press the [START MONITOR] menu key to start the monitor. Starting the monitor moves the focus to the list. "MONITOR" is also displayed in the top-right of the screen.



- (6) Use the up/down arrow keys, Page Up key, and Page Down key to move within the list and check the monitoring status of the devices downstream and upstream from the specified device.

Stopping the monitor

- (1) Pressing the [STOP MONITOR] menu key while monitoring devices stops the monitor. "MONITOR" display in the top-right of the screen is also canceled.



6.17.2.7 Closing the Device Batch Monitor Screen

Use any of the following methods to close the device batch monitor screen.

Methods to close the screen
Press the [CLOSE] menu key.
Press the left arrow key.
Press the [ESC] key on the software keyboard.

6.17.3 Entry Device Monitor Screen

6.17.3.1 Outline

This monitors devices at separated positions in ladders or different types of devices simultaneously on one screen. The program cannot be searched by label name.

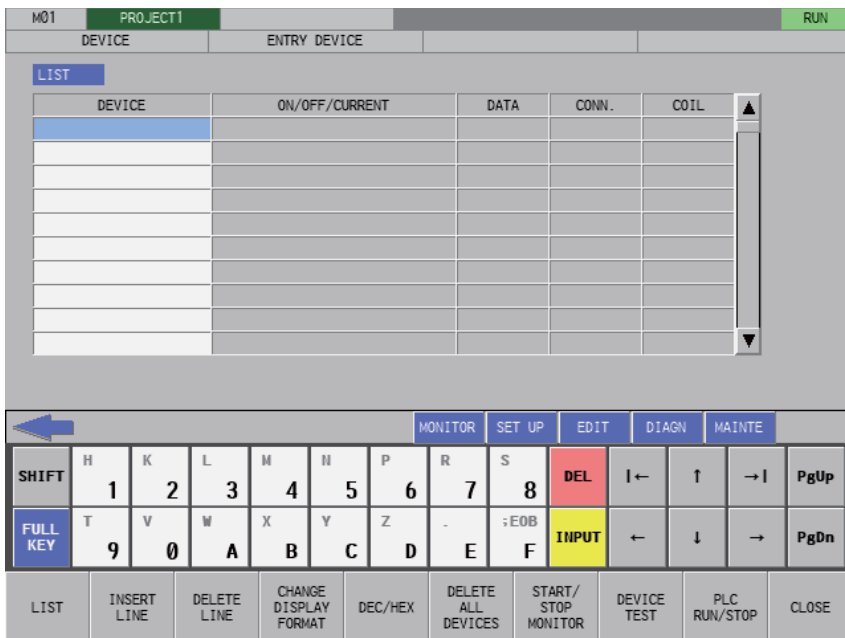

6.17.3.2 Screen Display Items

The following table describes the screen display items for the file list screen.

Item name	Display state
Connected NC name	This displays the name of the connected NC.
Current project No.	This displays the current project number.
Current project label	This displays the project label.
Monitor/Edit display	Starting the monitor displays [MONITOR]. Stopping the monitor cancels the display.
PLC status (RUN/STOP) display	This displays the PLC status (RUN/STOP) for the monitored project.
Alarm message	This is displayed when alarms occur.
Left arrow key	This is displayed when enabled.
Software keyboard	This is displayed only when parameters are enabled.
List	This displays the monitored device, current project, and monitoring results.

6.17.3.3 Enabled/Disabled State of Menu Keys

The menu keys displayed on the entry device monitor screen are always enabled.

6.17.3.4 Status during Screen Displays

The following table describes the status when displaying the entry device monitor screen.

Item name	Operation
List	This is left blank.

6.17.3.5 Operation of Key Presses

The following table describes the operation of each menu key and the keys on the NC keyboard when pressed.

Item name	Operation
Left arrow key	Refer to "6.17.3.9 Closing the Entry Device Monitor Screen".
LIST	The focus is applied to the list.
INSERT LINE	This inserts a blank line at the cursor position in the list.
DELETE LINE	This deletes one blank line at the cursor position in the list.
CHANGE DISPLAY FORMAT	This switches the display of the current value in the list between a 16-bit display, a 32-bit display, a single precision display, a double precision display, and a string display.
DEC/HEX	This switches the display of the current value in the list between a decimal display and a hexadecimal display.
DELETE ALL DEVICES	This deletes all the devices registered in the list. Refer to "6.17.3.7 Deleting Devices".
START/STOP MONITOR	Refer to "6.17.3.8 Starting and Stopping the Monitor for the Selected Device".
DEVICE TEST	This displays the device test popup screen. Refer to "6.15.5 Device Test Popup Screen".
PLC RUN/STOP	This displays the PLC RUN/STOP screen. Refer to "6.13.10 PLC RUN/STOP Popup Screen".
Close	Refer to "6.17.3.9 Closing the Entry Device Monitor Screen".

6.17.3.6 Entering Devices for Monitoring

Use the following procedure to enter devices for monitoring.

- (1) Press the [LIST] menu key to select the list.
- (2) Use the up/down arrow keys, Page Up key, and Page Down key to move to the desired position in the device display column in the list.
- (3) Press the [INPUT] key to display the device entry field at the bottom of the list and move the focus.

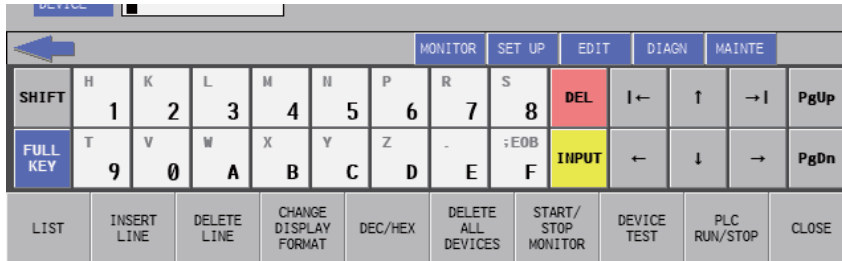

- (4) Enter the device you want to monitor and then press the [INPUT] key. Press the [INPUT] key to close the device entry field. The entered device displays at the cursor position in the list.

6.17.3.7 Deleting Devices

Single deletions (1)

- (1) Use the up/down arrow keys, Page Up key, and Page Down key to move to the position where the device you want to delete is displayed in the device display column in the list.
- (2) Press the [DELETE] key. Press the [DELETE] key. The device at the cursor position will be deleted by pressing the [DELETE] key. The project No. display in the same line is also removed.

Single deletions (2)

- (1) Use the up/down arrow keys, Page Up key, and Page Down key to move to the position where the device you want to delete is displayed in the device display column in the list.
- (2) Press the [DELETE LINE] menu key. Pressing the [DELETE LINE] menu key deletes the line at the cursor position in the list and moves the remaining lines below the cursor position up one line.

Delete all devices

- (1) Press the [DELETE ALL DEVICES] menu key. Pressing the [DELETE ALL DEVICES] menu key displays the following message screen.

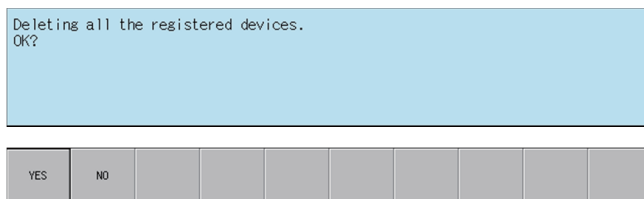

- (2) Pressing the [YES] menu key closes the message screen and all devices registered in the list are deleted. The project No. display in the same line as the device is also deleted. Pressing the [NO] menu key closes the message screen and returns to the entry device monitor screen.

6.17.3.8 Starting and Stopping the Monitor for the Selected Device

- (1) Refer to "Entering Devices for Monitoring" and enter the device you want to monitor into the list.
- (2) Press the [CHANGE DISPLAY FORMAT] menu and select whether the current value is displayed in a 16-bit display, a 32-bit display, a single precision display, a double precision display, and a string display
- (3) Press the [DEC/HEX] menu and select whether the current value is displayed in decimal or hexadecimal numbers.
- (4) Press the [START/STOP MONITOR] menu to start the monitor. Starting the monitor moves the focus to the list. [MONITOR] is also displayed in the top-right of the screen.



- (5) Use the up/down arrow keys, Page Up key, and Page Down key to move within the list and check the monitoring status of other specified devices.

Stopping the monitor

- (1) Pressing the [START/STOP MONITOR] menu key while monitoring devices stops the monitor. The [MONITOR] display in the top-right of the screen is also canceled.



6.17.3.9 Closing the Entry Device Monitor Screen

Use any of the following methods to close the entry device monitor popup screen.

Methods to close the screen
Press the [CLOSE] menu key.
Press the left arrow key.
Press the [ESC] key on the software keyboard.

6.17.4 Sampling Trace

The sampling trace function traces (data collection) PLC device (Bit devices and word devices) signals, and displays the trace results in chronological order to confirm and analyze the device signal status.

The program cannot be searched by label name.

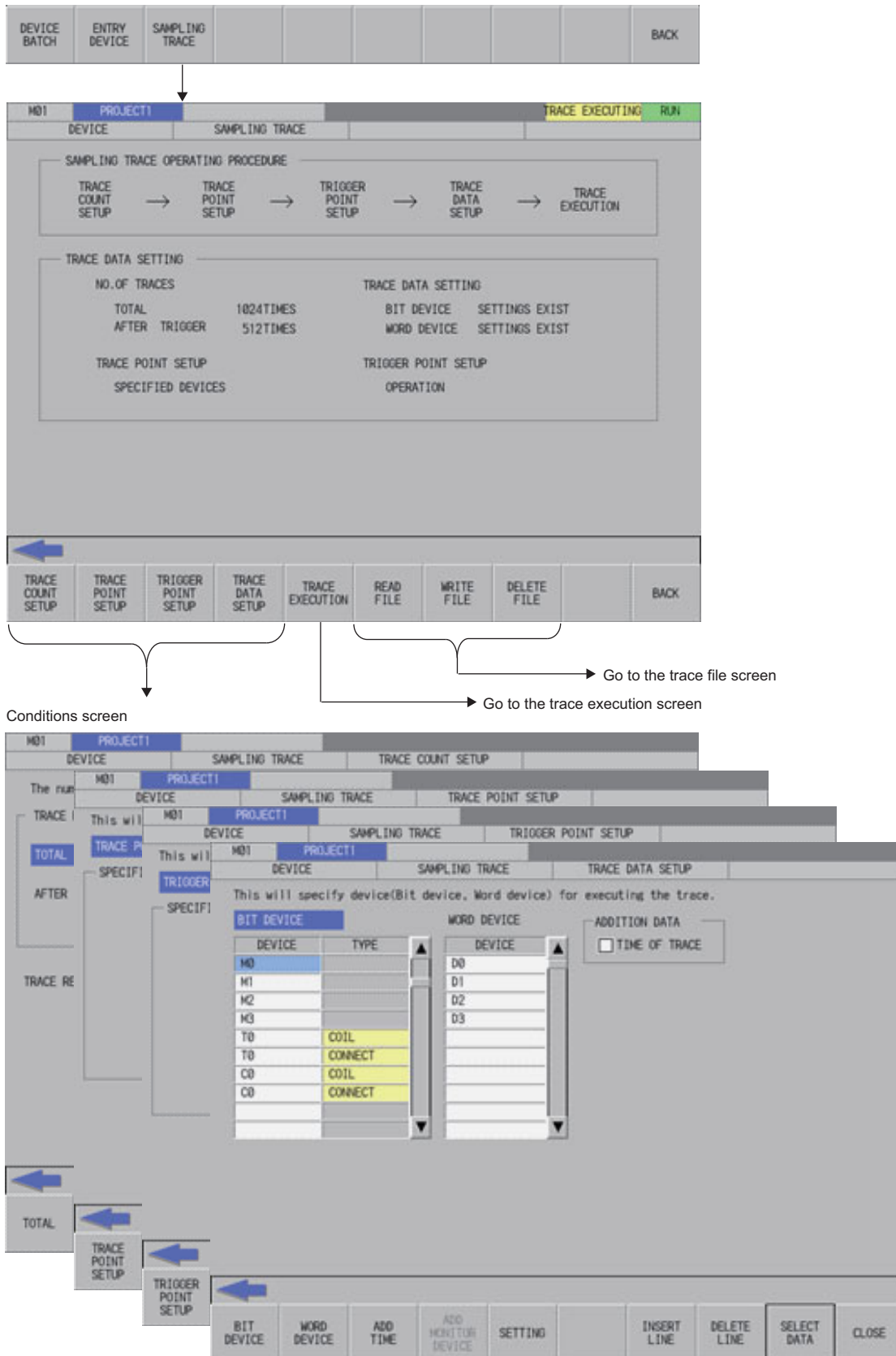

6 Explanation of Built-in Editing Function (PLC On-board)

6.17 Device Menus

Trace execution screen

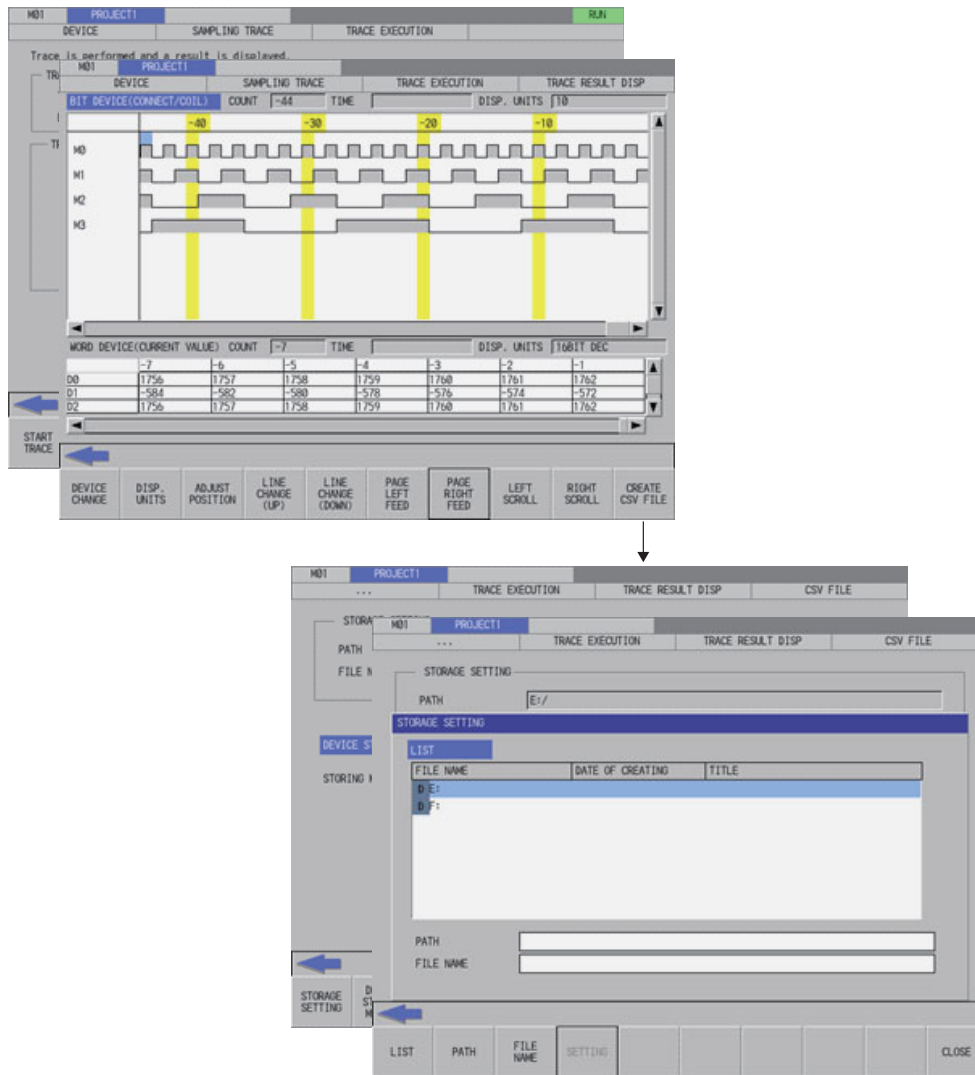

Trace file screen

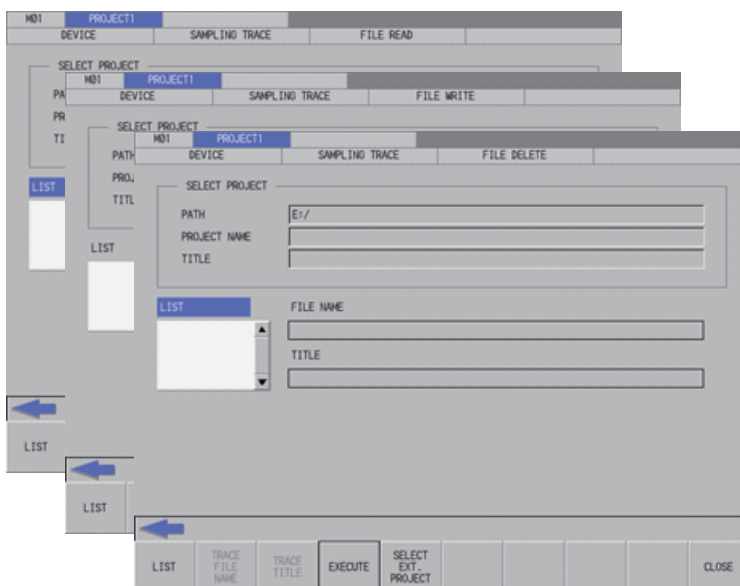

Trace conditions (Data collection conditions)

Items	Specifications	
No. of traces (number of times for collecting trace data)	The number between 1 and 8192 can be set. Note that, however, when the max project No. is 1, the trace data size has to be smaller than 220 kilobytes. For the trace data size calculation and the size of each max project No., refer to (*1).	
No. of traces after trigger	Sets the number smaller than the No. of traces.	
Trace repeat	The trace execution can be repeated. (After a trace execution, the trace is restarted automatically.) The trace is repeated until the trace stops.	
Trace point (Timing of collecting data)	Each high scan	Traces per scan of the PLC high speed process. <Note> • The trace data can be set are limited to 8 points or less of bit devices. • This cannot be selected with the user safety sequence "SafePLC1" or "SafePLC2". If this is selected, the error occurs when the sampling trace is executed.
	Each main scan	Traces per scan of PLC main process.
	Trace data change	Traces when the device that is set by trace data at every scan of the main process changed. (Bit device: OFF -> ON, ON -> OFF, Word device: value)
	Specified devices	Traces when the setup condition of specified devices on the "Trace point set-up" screen is satisfied at every scan of the main process. Refer to (*2) for the applicable devices.
Trigger point (The point of trigger condition satisfied)	Operation	Executes trigger by pressing [TRIGGER EXECUTION] button on the trigger execution screen.
	Specified devices	Executes trigger by one of the following methods. • Press the [EXECUTE TRIGGER] button on the trigger execution screen. • When the setup conditions of specified devices on the trigger point setup screen are satisfied. Refer to (*2) for the applicable devices.
Trace addition data	Time (Displayed in hour:minute:second) <Note> • The step No., program name cannot be added.	

Trace data (data collection)

Items	Specifications
Bit device	50 points of word devices and 50 points of bit devices can be set. Note that, however, when the max project No. is 1, the trace data size has to be smaller than 220 kilobytes. For the trace data size calculation and the size of each max project No., refer to (*1). Refer to (*3) for the applicable devices.
Word device	

Trace execution

Items	Specifications
Start Trace	This starts a trace (data collection) by pressing the [START TRACE] button on the trace execution screen.
Stop trace	This stops a trace (data collection) by pressing the [STOP TRACE] button on the trace execution screen.

Trace result display

Items	Specifications
Trace result display screen	This displays the data for the number of traces (or the number of traces until the trace stop) on the trace result display screen.
Output trace result	This outputs the trace result to the external device in CSV file format.

6 Explanation of Built-in Editing Function (PLC On-board)

6.17 Device Menus

File I/O (read/write)

Items	Specifications
Input (read)	This reads the trace files (trace conditions and trace results) stored in the external device. (The trace files are included in GX Developer projects.) For the file convertibility with GX Developer, refer to (*4).
Output (write)	This writes the trace files (trace conditions and trace results) to the external device. (The trace files are included in GX Developer projects.) For the file convertibility with GX Developer, refer to (*4).
Delete	This deletes the trace files (trace conditions and trace results) of the external device. (The trace files are included in GX Developer projects.)

(*1) Trace data size calculation

The size of trace data per project depends on the max project No.

The size of trace data for the user safety sequence "SafePLC1" and "SafePLC2" are fixed to 220 kilobytes respectively.

The size of trace data per project for different numbers of maximum project No.

Max project No.	Maximum size of trace data per project
1	220 kilobytes
2	103 kilobytes
3	64 kilobytes
4	44 kilobytes
5	32 kilobytes
6	25 kilobytes

Set the number of traces and the trace devices when the maximum project No. is 6, so that the trace device data size will be 25 kilobytes (25600 bytes) or smaller.

Trace data size is calculated as follows.

$$[\text{Trace data size (byte)}] = [\text{Size required for one trace (byte)}] \times [\text{Number of traces}]$$

Size required for one trace is calculated from word device points and bit device points of the trace device and the size required for one trace of each device.

Trace device type	Size (byte) required for one trace
Word device	2 bytes per point
Bit device	2 bytes per unit (1 unit = 16 points) 1 to 16 points -> 1 unit -> 2 bytes 17 to 32 points -> 2 units -> 4 bytes 33 to 48 points -> 3 units -> 6 bytes 49 to 50 points -> 4 units -> 8 bytes

Calculation example for trace data size is shown below.

Trace data size calculation example

(When the maximum project No. is "3": The maximum project size is 64 kilobytes)

No.	Bit device points	Word device points	Trace points	Trace data size	Sampling
1	16 (1 unit)	2	8192 point	$(1 \times 2 + 2 \times 2) \times 8192 = 49152$ bytes	Possible
2	8 (1 unit)	8 point	1000 point	$(1 \times 2 + 8 \times 2) \times 1000 = 18000$ bytes	Possible
3	50 points (4 units)	50 point	606 point	$(4 \times 2 + 50 \times 2) \times 606 = 65448$ bytes	Possible
4	50 points (4 units)	50 point	607 point	$(4 \times 2 + 50 \times 2) \times 607 = 65556$ bytes	Not possible

(*2) Applicable devices with trace/trigger point details setting

Applicable devices when the project is selected
Bit device: X, Y, M, L, F, SB, B, SM, T (contact), ST (contact), C (contact) Word device: T (current value), ST (current value), C (current value), D, R, SW, SD, W, ZR
Applicable devices when the user safety sequence is selected
Bit device: X, Y, M, SM, T (contact), T (coil), ST (contact), ST (coil), C (contact), C (coil) Word device: T (current value), ST (current value), C (current value), D, R (SafePLC1 only), SD, W, ZR

The qualifications, "bit device digit designation" and "word device bit designation", are available for the following device.

The program cannot be searched by label name.

When an inapplicable device is set, an error will be displayed when reading a trace setup file for trace execution.

(*3) Applicable devices with device setting

Applicable devices when the project is selected
Bit device: X, Y, M, L, F, SB, B, SM, T (contact), T (coil), ST (contact), ST (coil), C (contact), C (coil) Word device: T (current value), ST (current value), C (current value), D, R, SW, SD, W, ZR
Applicable devices when the user safety sequence is selected
Bit device: X, Y, M, SM, T (contact), ST (contact), C (contact) Word device: T (current value), ST (current value), C (current value), D, R (SafePLC1 only), SD, W, ZR

The qualifications, "bit device digit designation" and "word device bit designation", are available for the following device.

The program cannot be searched by label name.

The following indicates the process of when an inapplicable device has been set.

- If one or more applicable devices already exist, the setting of the inapplicable device will be ignored.
- If no applicable devices exist, an error will be displayed when reading a trace setup file for trace execution.

(*4) For the trace file compatibility

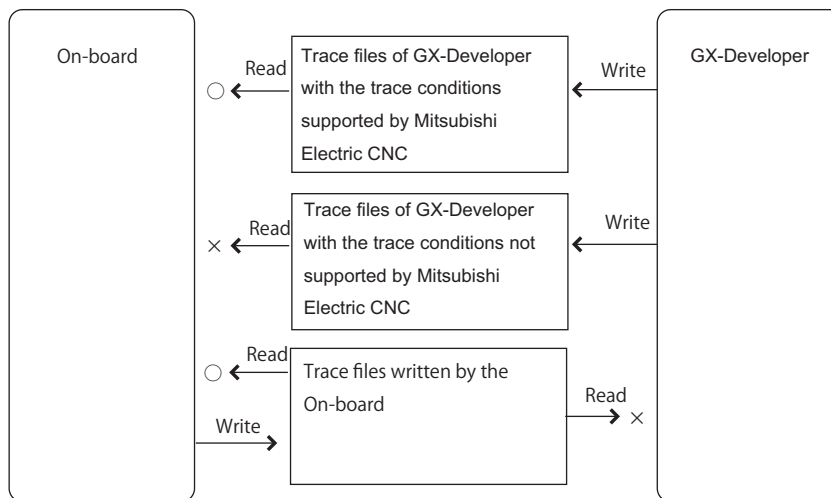

(*) The trace files which can be deleted are limited to the files written by the On-board.

[For the trace file written in NC with GX Developer.]

The trace files written in NC by GX Developer can be read because of the upper compatibility with the Onboard trace files.

[For the multi-project]

The sampling trace can be set up a trace for each project.

The target is the connected project of the connected NC (displayed upper left on the screen). To switch the target, change the connected project or connected NC. The trace continues with NC even if the target is switched during the trace execution.

For example, even when switching to project 3 and executing the trace after executing the trace by connecting project 1, the change does not effect to the project 1. Moreover, it is possible to check the trace result of project 1 by reconnecting project 1.

6.17.4.1 Sampling Trace Main Screen

Outline

This displays menus for controlling sampling trace of PLC.

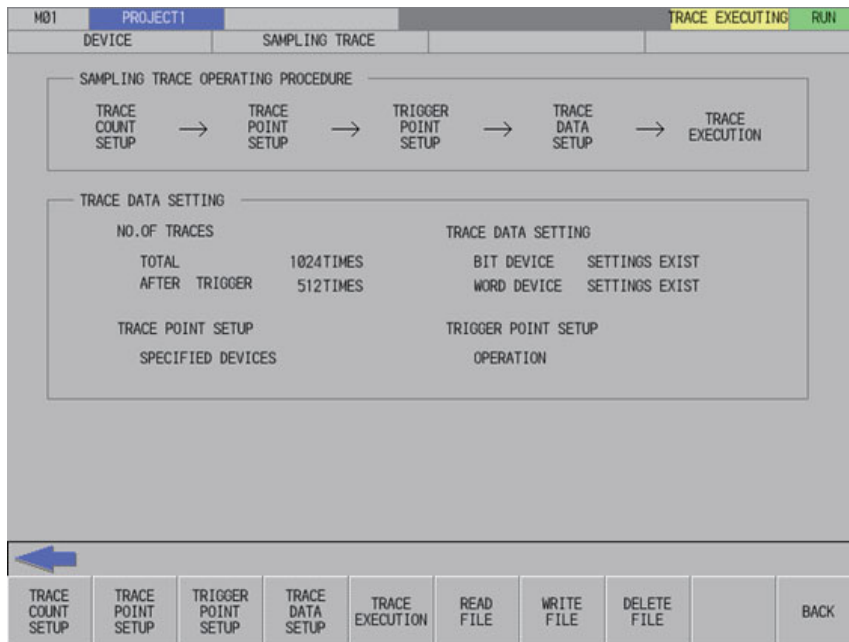

Screen display items

The following table describes the screen display items for the sampling trace main screen.

Item name	Display state
Connected NC name	This displays the name of the connected NC.
Current project No.	This displays the current project number.
Current project label	This displays the project label.
Trace status display	This displays the trace status (execution failed, trace executing, trace suspend or trace finished).
PLC status (RUN/STOP) display	This displays the PLC status (RUN/STOP) of the trace target project.
Alarm message	Alarm messages are displayed when alarms occur.
Left arrow key	This is displayed when enabled.
Software keyboard	This is displayed only when parameters are enabled.
Sampling trace operating procedure	This displays the operating procedure to execute the sampling trace.
Trace data setting	The trace condition details are displayed.

Enabled/disabled State of Menu Keys

The following table describes the conditions upon which menu keys displayed on the sampling trace main screen are enabled/disabled. The menu keys which are not described in the following table are always enabled.

Menu name	Condition upon which it is enabled/disabled
File I/O	Hidden when operation mode is GX Works2.
File I/O	Hidden when operation mode is GX Works2.
DELETE FILE	Hidden when operation mode is GX Works2.

Operation of key presses

The following table describes the operation of each menu key and the keys on the NC keyboard when pressed.

Item name	Operation
Left arrow key/return menu key	These transition to the main menu.
Close	This displays the specified screen.

6.17.4.2 Trace Count Setup Screen

Outline

The total number of traces and the number of traces after trigger can be specified.

Total (Default: 1024 times)	Sets the number of traces between 1 to 8192.
After trigger (Default: 512 times)	Sets the number of traces after trigger. The setting value has to be smaller than the number of traces.

Note

- (1) The settings such as the "No. of traces" and so on are valid after pressing the [SETTING] menu key.
- (2) The trace conditions are retained in the NC at the start of tracing.
If you start the on-board and open the sampling trace screen, the screen shows the retained conditions even after the NC power OFF.
If you set the trace conditions, and then turn OFF the NC power before starting tracing, the previous conditions before the setting are applied.
- (3) The entry settings are disabled during the trace execution. (An error message appears.)
- (4) If the value greater than 8192 times is input to the total number and the focus is moved to the other entry field or selection field, the input value of total number is changed to "8192" automatically.

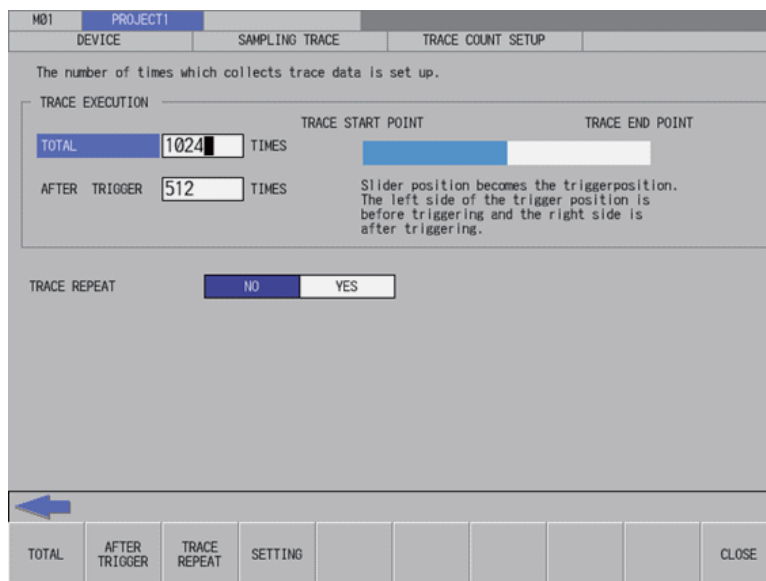

Screen display items

The following table describes the screen display items on the trace count setup screen.

Item name	Display state
Connected NC name	This displays the name of the connected NC.
Current project No.	This displays the current project number.
Current project label	This displays the project label.
Alarm message	Alarm messages are displayed when alarms occur.
Left arrow key	This is displayed when enabled.
Software keyboard	This is displayed only when parameters are enabled.
Total	This displays the total number of traces.
After trigger	This displays the number of traces after trigger.
Trace repeat	This displays the trace repeat status.

Enabled/disabled state of menu keys

The menu keys displayed on the trace count setup screen are always enabled.

Status during screen displays

The following table describes the status when the trace count setup screen is displayed.

Item name	Operation
Total	1024 is displayed.
After trigger	512 is displayed.
Trace repeat	This selects the [NO] option.

Operation of key presses

The following table describes the operation of each menu key and the keys on the NC keyboard when pressed.

Item name	Operation
Left arrow key	Refer to "Closing the trace count setup screen".
Total	The focus is applied to the Total.
After trigger	The focus is applied to the After trigger.
Trace repeat	The focus is applied to the Trace repeat. This changes the Trace repeat selection when the focus is already applied.
Setting	Refer to "Trace count setup".
Close	Refer to "Closing the trace count setup screen".

Trace count setup

■ Normal operation

- (1) Press the menu key [TOTAL], and enter the number of traces.
- (2) Press the menu key [AFTER TRIGGER], and enter the number of traces after trigger.
- (3) Press the menu key [TRACE REPEAT], and then select the repeat.
- (4) Press the menu key [SETTING] to fix the setting values of traces. Pressing the menu key [SETTING] also closes the trace count setup screen. Then, the screen returns to the sampling trace main screen.

■ Note

- (1) If the number of traces is less than the number of traces after trigger when entering and setting the trace count setup, the number of traces after trigger is corrected to the number of traces.

■ Abnormal operation

This information describes the details of error messages displayed on the trace count setup screen and the corrective action thereof.

Error message	Error details	Remedy
There is an error in the total times setting.	This is displayed when the total number of traces exceeds the setting range.	Enter the total number of traces within the setting range.
There is an error in the number of times after trigger setting.	This is displayed when the number of traces after trigger exceeds the setting range.	Enter the total number of traces after trigger within the setting range.
The PLC cannot execute during trace. Execute again after trace is completed.	This is displayed when setting is executed during trace.	Execute the operation during trace stop.

Closing the trace count setup screen

Use any of the following methods to close the trace count setup screen.

Methods to close the screen
Press the [SET] menu key.
Press the [CLOSE] menu key.
Press the left arrow key.
Press the [ESC] key on the software keyboard.

6.17.4.3 Trace Point Setup Screen

Outline

The trace point (the timing to collect data) can be specified.

How to specify the trace point is as follows.

Each main scan (default)	This collects trace data every times after executing the main scan.
Each high scan	This collects trace data after every scan of PLC high speed process. The bit devices which can be set up as the trace data are limited to 8 points or less. This cannot be selected with the user safety sequence "SafePLC1" or "SafePLC2". If this is selected, the error occurs when the sampling trace is executed.
Trace data change	This collects the trace data when changing the status of device set in the trace data setup per main process scanning. If many devices are registered for the trace data setup, the trace data is collected even when any one of them changes. The available devices which can be set as the trace data are limited to 8 points for the bit device and 2 or less points for the word device.
Specified devices	This collects the trace data when the setup condition registered in the specified devices field per scan of the main process is satisfied. Up to 8 points of bit device and 2 points of word device can be specified. Device cannot be specified with label name.

The followings can be set for the trace point conditions when the devices are specified.

	CONDI.	
Bit device setup	↑	When the bit device is changed from OFF to ON
	↓	When the bit device is changed from ON to OFF
	ON	When the bit device is ON
	OFF	When the bit device is OFF
Word device setup	=	Equal to the value
	<>	Not equal to the value
	>	Smaller than the value
	<=	Smaller than or equal to the value
	>=	Bigger or equal to the value
	Change	The value changed
	Mask	This checks the satisfied condition after masking (AND) the value of traced device with the mask value. (e.g.) Device D100: Current value 12A5 (hex) Trace condition =, Value of trace condition 1200 (hex), Mask of trace condition FF00 (hex) (1) Masking the trace point data. 12A5 & FF00 = 1200 (2) Checking the trace condition. Equal to the value ? 1200 = 1200 Therefore, the condition is satisfied.
Device setup condi.	AND	When all the setup conditions in bit device setup and word device setup are satisfied.
	OR	When any of the setup conditions in bit device setup and word device setup is satisfied.

Note

- (1) The settings such as "trace point setup" and so on are valid after pressing the [SETTING] menu key.
- (2) The trace conditions are retained in the NC at the start of tracing.
If you start the on-board and open the sampling trace screen, the screen shows the retained conditions even after the NC power OFF.
If you set the trace conditions, and then turn OFF the NC power before starting tracing, the previous conditions before the setting are applied.
- (3) The entry settings are disabled during the trace execution. (An error message appears.)

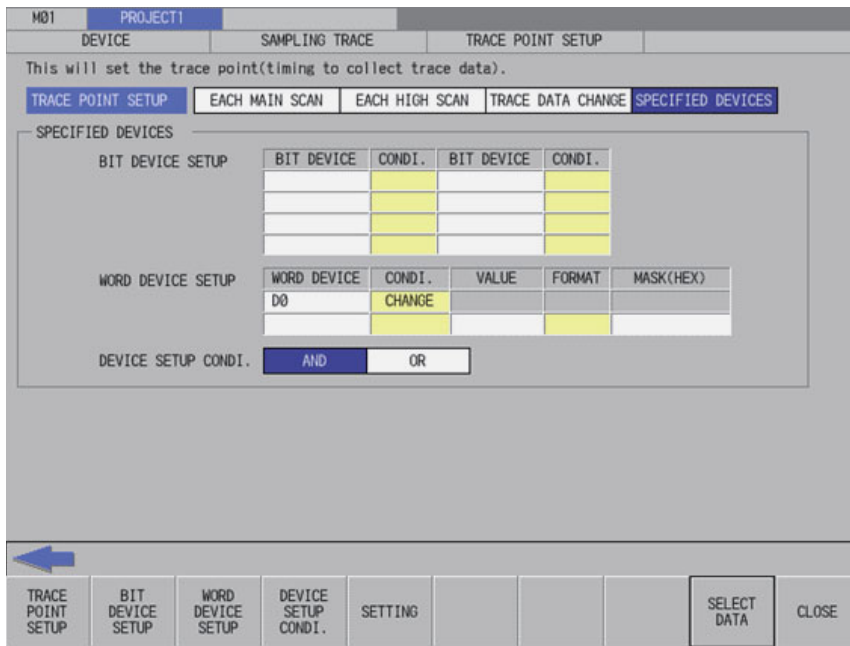

Screen display items

The following table describes the screen display items on the trace point setup screen.

Item name	Display state
Connected NC name	This displays the name of the connected NC.
Current project No.	This displays the current project number.
Current project label	This displays the project label.
Alarm message	Alarm messages are displayed when alarms occur.
Left arrow key	This is displayed when enabled.
Software keyboard	This is displayed only when parameters are enabled.
Specified devices	This displays the specified device and device setup conditions when the trace point is "SPECIFIED DEVICES".

Enabled/disabled state of menu keys

The following table describes the conditions upon which menu keys displayed on the trace point setup screen are enabled/disabled.

The menu keys which are not described in the following table are always enabled.

Menu name	Condition upon which it is enabled/disabled
Bit device setup	Enabled when the trace point is "SPECIFIED DEVICES".
Word device setup	Enabled when the trace point is "SPECIFIED DEVICES".
Device setup condi.	Enabled when the trace point is "SPECIFIED DEVICES".
Select data	Enabled when the trace point is "SPECIFIED DEVICES", and the focus is at the "SPECIFIED DEVICES".

Status during screen displays

The following table describes the status when the trace point setup screen is displayed.

Item name	Operation
Trace point setup	This selects "EACH MAIN SCAN".
Specified devices	This is left blank with entry disabled state.

Operation of key presses

The following table describes the operation of each menu key and the keys on the NC keyboard when pressed.

Item name	Operation	
Left arrow key	Refer to "Closing the trigger point setup screen".	
Trace point setup	The focus is applied to the trace point setup. This changes the trace point setup selection when the focus is already applied.	
Bit device setup	The focus is applied to the bit device field. The cursor is displayed at the beginning of the bit device list.	
Word device setup	The focus is applied to the word device field. The cursor is displayed at the beginning of the word device list.	
Device setup condi.	The focus is applied to the device setup condi. field. This changes the device setup condi. selection when the focus is already applied.	
Setting	Refer to "Trace point setup".	
Select data	Cursor position	
	Bit device ("BIT DEVICE" column)	This displays the device entry field.
	Bit device ("CONDI." column)	This changes the condition selection.
	Word device ("WORD DEVICE" column)	This displays the device entry field.
	Word device ("VALUE" column)	This displays the value entry field.
	Word device ("MASK(HEX)" column)	This displays the mask entry field.
	Word device ("CONDI./FORMAT" column)	This changes the selection.
	Device setup condi.	This changes the selection.
Close	Refer to "Closing the trigger point setup screen".	

Entering specified devices

When the trace point is set to "specified devices", the specified device field becomes enabled.

How to enter the specified devices fields is as follows.

■ Entering devices

- (1) Press the menu key [BIT DEVICE SETUP] or [WORD DEVICE SETUP] to select the bit device setup or word device setup.
- (2) Use up, down, left or right arrow key to move to the arbitrary position of device column.
- (3) Press the [INPUT] key to display the device entry field at the bottom of the list and move the focus.



- (4) Enter the device you want to specify, and press the [INPUT] key. Then, the device entry field is closed, and the entered device is displayed at the cursor position in the specified devices.
Device cannot be specified with label name.

■ Deleting Devices

- (1) Use up, down, left or right arrow key to move the cursor to the device position you want to delete in the device column.
- (2) Press the [DELETE] key. The device at the cursor position will be deleted by pressing the [DELETE] key.

■ Entering the condition for bit devices

- (1) Press the menu key [BIT DEVICE SETUP] to select the bit device setup.
- (2) Use up, down, left or right arrow key to move the cursor to the arbitrary position in the condition column.
- (3) Press the [INPUT] key in the condition field based on "Setting selection items in lists" in "Operation key List: Screen Items (Control)". The conditions will be displayed in order. (" ↑ " -> " ↓ " -> "ON" -> "OFF" -> " ↑ " -> ...)

BIT DEVICE SETUP	BIT DEVICE	CONDI.	BIT DEVICE	CONDI.
	M0	↑		

■ Entering the condition for word devices

- (1) Press the menu key [WORD DEVICE SETUP] to select the word device setup.
- (2) Use up, down, left or right arrow key to move the cursor to the arbitrary position in the condition column.
- (3) Press the [INPUT] key in the condition field based on "Setting selection items in lists" in "Operation key List: Screen Items (Control)". The conditions will be displayed in order. ("=" -> "<>" -> "<" -> ">" -> "<=" -> ">=" -> CHANGE -> "=" -> ...)

WORD DEVICE SETUP	WORD DEVICE	CONDI.	VALUE	FORMAT	MASK(HEX)
	D0	CHANGE			
	D0	=		DEC	FFFF

■ Entering the value of word devices

- (1) Press the menu key [WORD DEVICE SETUP] to select the word device setup.
- (2) Use up, down, left or right arrow key to move the cursor to the arbitrary position of value column.
- (3) Press the [INPUT] key to display the value entry field below the list, and the focus is applied.

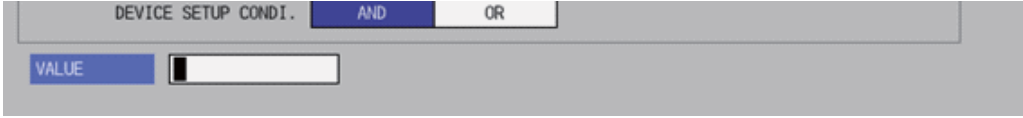

- (4) Enter the value you want to specify, and press the [INPUT] key. When pressing [INPUT] key, the value entry field is closed, and the entered value is displayed at the cursor position in the specified devices.

■ Entering the format for word devices

- (1) Press the menu key [WORD DEVICE SETUP] to select the word device setup.
- (2) Use up, down, left or right arrow key to move the cursor to the arbitrary position of format column.
- (3) Press the [INPUT] key in the format field based on "Setting selection items in lists" in "Operation key List: Screen Items (Control)". The format will be displayed in order. (DEC -> HEX -> DEC -> ...)

WORD DEVICE SETUP	WORD DEVICE	CONDI.	VALUE	FORMAT	MASK(HEX)
	D0	<>			
	D0	=	0	DEC	FFFF

■ Entering the mask for word devices

- (1) Press the menu key [WORD DEVICE SETUP] to select the word device setup.
- (2) Use up, down, left or right arrow key to move the cursor to the arbitrary position of mask column.
- (3) Press the [INPUT] key to display the mask entry field below the list, and the focus is applied.

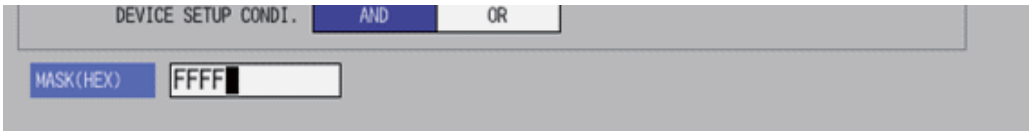

- (4) Enter the value you want to specify, and press the [INPUT] key. Press the [INPUT] key to close the device entry field. The entered device displays at the cursor position in the specified devices.

Trace point setup

■ Normal operation

- (1) Press the menu key [TRACE POINT SETUP] to select the trace point.
Go to (3) if there is no specified device.
- (2) Enter the specified devices in reference to "Entering specified devices".
- (3) Press the menu key [SETTING] to fix the trace point setup entries. Pressing the menu key [SETTING] also closes the trace point setup screen, and the screen returns to the sampling trace main screen.

■ Abnormal operation

This information describes the details of error messages displayed on the trace point setup screen and the corrective action thereof.

Error message	Error details	Remedy
There was an error in the device specification method. Input a bit device for the device.	This is displayed when something other than a bit device was set.	Set a bit device.
There was an error in the device specification method. Input a word device for the device.	This is displayed when something other than a word device was set.	Set a word device.
The NC cannot execute during trace. Execute again after trace is completed.	This is displayed when setting is executed during trace.	Execute the operation during trace stop.
A bit device setup of specified devices is incorrect.	This is displayed when either the bit device or the condition is not set.	Set both of the bit device and the condition.
A word device setup of specified devices is incorrect.	This is displayed when either the word device or the condition is not set.	Set both of the word device and the condition.
The trace point setup is not selected.	This is displayed when none of the trace point is set.	Set the trace point.

Closing the trace point setup screen

Use any of the following methods to close the trace point setup screen.

Methods to close the screen
Press the [SET] menu key.
Press the [CLOSE] menu key.
Press the left arrow key.
Press the [ESC] key on the software keyboard.

6.17.4.4 Trigger Point Setup Screen

Outline

The trigger point (the starting point (0 point) of the trace execution) can be specified.

How to specify the trigger point is as follows.

Operation (default)	Set up the trigger at the "Execute trigger" on the trace execution screen.
Specified devices	Set up the trigger when the trigger execution by the "Execute trigger" in the trace execution screen and the registered setup conditions on the specified devices are satisfied. It is possible to specified up to 8 points for the bit device and 2 points for the word device. Device cannot be specified with label name.

The followings can be set for the trigger point conditions when the devices are specified.

	CONDI.	
Bit device setup	↑	When the bit device is changed from OFF to ON
	↓	When the bit device is changed from ON to OFF
	ON	When the bit device is ON
	OFF	When the bit device is OFF
Word device setup	=	Equal to the value
	<>	Not equal to the value
	>	Smaller than the value
	>	Bigger than the value
	<=	Smaller than or equal to the value
	>=	Bigger or equal to the value
	Change	The value changed
	Mask	This checks the satisfied condition after masking (AND) the value of traced device with the mask value. (e.g.) Device D100: Current value 12A5 (hex) Trace condition =, Value of trace condition 1200 (hex), Mask of trace condition FF00 (hex) (1) Masking the trace point data. 12A5 & FF00 = 1200 (2) Checking the trace condition. Equal to the value ? 1200 = 1200 Therefore, the condition is satisfied.
Device setup condi.	AND	When all the setup conditions in bit device setup and word device setup are satisfied.
	OR	When any of the setup conditions in bit device setup and word device setup is satisfied.

Note

(1) The settings such as "trace point setup" and so on are valid after pressing the [SETTING] menu key.

(2) The trace conditions are retained in the NC at the start of tracing.

If you start the on-board and open the sampling trace screen, the screen shows the retained conditions even after the NC power OFF.

If you set the trace conditions, and then turn OFF the NC power before starting tracing, the previous conditions before the setting are applied.

(3) The entry settings are disabled during the trace execution. (An error message appears.)

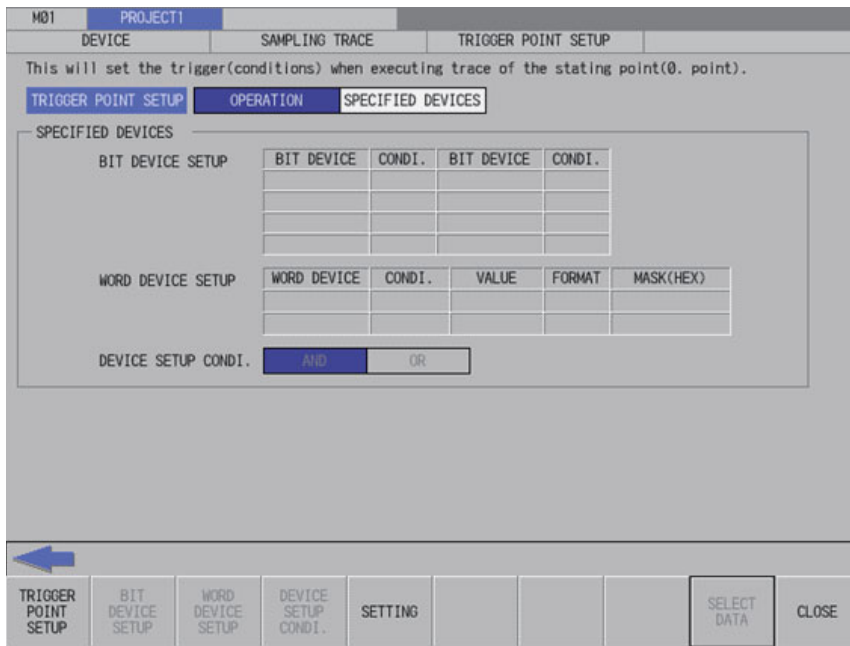

Screen display items

The following table describes the screen display items on the trigger point setup screen.

Item name	Display state
Connected NC name	This displays the name of the connected NC.
Current project No.	This displays the current project number.
Current project label	This displays the project label.
Alarm message	Alarm messages are displayed when alarms occur.
Left arrow key	This is displayed when enabled.
Software keyboard	This is displayed only when parameters are enabled.
Specified devices	This displays the specified device and device setup conditions when the trigger point is "SPECIFIED DEVICES".

Enabled/disabled state of menu keys

The following table describes the conditions upon which menu keys displayed on the trigger point setup screen are enabled/disabled.

The menu keys which are not described in the following table are always enabled.

Menu name	Condition upon which it is enabled/disabled
Bit device setup	Enabled when the trigger point is "SPECIFIED DEVICES".
Word device setup	Enabled when the trigger point is "SPECIFIED DEVICES".
Device setup condi.	Enabled when the trigger point is "SPECIFIED DEVICES".
Select data	Enabled when the trigger point is "SPECIFIED DEVICES", and the focus is at the "SPECIFIED DEVICES".

Status during screen displays

The following table describes the status when the trigger point setup screen is displayed.

Item name	Operation
Trigger point setup	This selects "OPERATION".
Specified devices	This is left blank with entry disabled state.

Operation of key presses

The following table describes the operation of each menu key and the keys on the NC keyboard when pressed.

Item name	Operation	
Left arrow key	Refer to "Closing the trigger point setup screen".	
Trigger point setup	The focus is applied to the trigger point setup. This changes the trigger point setup selection when the focus is already applied.	
Bit device setup	The focus is applied to the bit device field.	
Word device setup	The focus is applied to the word device field.	
Device setup condi.	The focus is applied to the device setup condi. field. This changes the device setup condi. selection when the focus is already applied.	
Setting	Refer to "Trigger point setup".	
Select data	Cursor position	
	Bit device ("BIT DEVICE" column)	This displays the device entry field.
	Bit device ("CONDI." column)	This changes the condition selection.
	Word device ("WORD DEVICE" column)	This displays the device entry field.
	Word device ("VALUE" column)	This displays the value entry field.
	Word device ("MASK(HEX)" column)	This displays the mask entry field.
	Word device ("CONDI./FORMAT" column)	This changes the selection.
	Device setup condi.	This changes the selection.
Close	Refer to "Closing the trigger point setup screen".	

Trigger point setup

■ Normal operation

- (1) Press the menu key [TRIGGER POINT SETUP] to select the trigger point.
Go to (3) other than the specified devices.
- (2) Enter the specified devices in reference to "Entering specified devices".
- (3) Press the menu key [SETTING] to fix the trigger point setup entries. Pressing the menu key [SETTING] also closes the trigger point setup screen, and the screen returns to the sampling trace main screen.

■ Abnormal operation

The error messages in abnormal operations are same as the error message displayed on the trace point setup screen. Refer to "Trace point setup screen: Trace point setup".

Closing the trigger point setup screen

Use any of the following methods to close the trigger point setup screen.

Methods to close the screen
Press the [SET] menu key.
Press the [CLOSE] menu key.
Press the left arrow key.
Press the [ESC] key on the software keyboard.

6.17.4.5 Trace Data Setup Screen

Outline

The device of the trace execution can be specified.

Device cannot be specified with label name.

Bit device	The devices can be registered up to 50 points. When the trace point is set at "EACH HIGH SCAN", the effective bit devices are limited to 8 points or less. When the trace point is set at "TRACE DATA CHANGE", the effective bit devices are limited to 8 points or less.
Word device	The devices can be registered up to 50 points. When the trace point is set at "TRACE DATA CHANGE", the effective word devices are limited to 2 points or less.
Add time (time added in the result information)	This enables to display the time of trace point in the "time" field on the trace result display screen. However, the available data size for trace will be smaller than normal when the add time is used.

Note

- (1) The settings are valid after pressing the [SETTING] menu key.
- (2) The trace conditions are retained in the NC at the start of tracing.
If you start the on-board and open the sampling trace screen, the screen shows the retained conditions even after the NC power OFF.
If you set the trace conditions, and then turn OFF the NC power before starting tracing, the previous conditions before the setting are applied.
- (3) The entry settings are disabled during the trace execution. (An error message appears.)

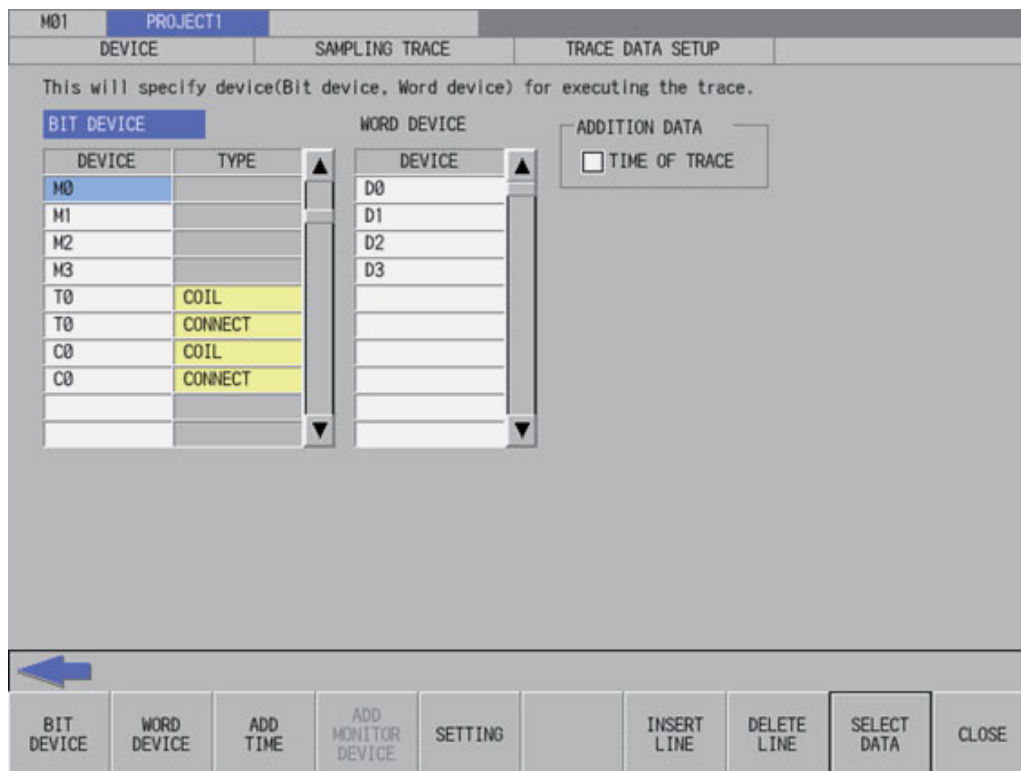

Screen display items

The following table describes the screen display items on the trace data setup screen.

Item name	Display state
Connected NC name	This displays the name of the connected NC.
Current project No.	This displays the current project number.
Current project label	This displays the project label.
Alarm message	Alarm messages are displayed when alarms occur.
Left arrow key	This is displayed when enabled.
Software keyboard	This is displayed only when parameters are enabled.
Bit device	This displays the specified bit device and the type.
Word device	This displays the specified word device.
Addition data	This displays the add time status.

Enabled/disabled state of menu keys

The following table describes the conditions upon which menu keys displayed on the trace data setup screen are enabled/disabled.

The menu keys which are not described in the following table are always enabled.

Menu name	Condition upon which it is enabled/disabled
Add monitor device	Enabled when a monitor device is registered.
Select data	Enabled when the focus is applied to the Bit device (type).

Status during screen displays

The following table describes the status when the trace data setup screen is displayed.

Item name	Operation
Bit device	This is left blank.
Word device	This is left blank.
Add time	This is displayed with the check box not selected.

Operation of key presses

The following table describes the operation of each menu key and the keys on the NC keyboard when pressed.

Item name	Operation	
Left arrow key	Refer to "Closing the trace data setup screen".	
Bit device setup	The focus is applied to the bit device field.	
Word device setup	The focus is applied to the word device field.	
Add time	The focus is applied to the Addition data field. This changes the Add time selection when the focus is already applied.	
Add monitor device	This adds the device registered in the entry device monitor to the bit device field or the word device field.	
Setting	Refer to "Trace data setup".	
Insert Row	This inserts a blank line at the cursor position. Lines are not inserted when a device is already set at the last line.	
Delete Row	This deletes a line at the cursor position and moves remaining data up.	
Select data	Cursor position	
	Bit device field ("DEVICE" column)	Device entry field is displayed.
	Bit device field ("TYPE" column)	Type selection can be changed.
	Word device field ("DEVICE" column)	Device entry field is displayed.
	Add time field	This changes the selection.(check/uncheck)
Close	Refer to "Closing the trace data setup screen".	

Entering trace devices

The entry method of trace device is as follows.

■ Entering devices

- (1) Press the menu key [BIT DEVICE] or [WORD DEVICE] to select the bit device or word device.
- (2) Use the up or down arrow key, or the Page-up or Page-down key to move the cursor to the arbitrary position of device column.
- (3) Press the [INPUT] key to display the device entry field at the bottom of the list and move the focus.



- (4) Enter the device you want to specify, and press the [INPUT] key. Then, the device entry field is closed, and the entered device is displayed at the cursor position in the specified devices.
Device cannot be specified with label name.

■ Deleting devices 1

- (1) Use up or down arrow key, PageUp, or PageDown key to move the cursor to the position where the device you want to delete is displayed in the device display column.
- (2) Pressing the [DELETE] key deletes the device at the cursor position.

■ Deleting devices 2

- (1) Use up or down arrow key, PageUp, or PageDown key to move the cursor to the position where the device you want to delete is displayed in the device display column.
- (2) Pressing the [DELETE LINE] menu key deletes the line at the cursor position in the list and moves the remaining lines below the cursor position up one line.

■ Entering the type of bit devices

- (1) Press the menu key [BIT DEVICE] to select the bit device setup.
- (2) Use up, down, left or right arrow key to move the cursor to the arbitrary position of type column.
- (3) Press the [INPUT] key in the type field based on "Setting selection items in lists" in "Operation key List: Screen Items (Control)". The type will be displayed in order. (COIL -> CONNECT -> COIL -> ...)

BIT DEVICE	
DEVICE	TYPE
M0	
M1	
M2	
M3	
T0	COIL
T0	CONNECT
C0	COIL
C0	CONNECT

Trace data setup

■ Normal operation

- (1) Enter the trace device in reference to "Entering trace devices".
- (2) Press the menu key [ADD TIME] to select the add time.
- (3) When pressing the [INPUT] key in the condition display field based on "Setting selection items in lists" in "Operation key List: Screen Items (Control)", the check or uncheck mark in the check box at the time of trace is switched.
- (4) Press the menu key [SETTING] to fix the trace data setup entries. Pressing the menu key [SETTING] also closes the trace data setup screen, and the screen returns to the sampling trace main screen.

■ Abnormal operation

This information describes the details of error messages displayed on the trace data setting screen and the corrective action thereof.

Error message	Error details	Remedy
There was an error in the device specification method. Input a bit device for the device.	This is displayed when something other than a bit device was set.	Set a bit device.
There was an error in the device specification method. Input a word device for the device.	This is displayed when something other than a word device was set.	Set a word device.
The NC cannot execute during trace. Execute again after trace is completed.	This is displayed when setting is executed during trace.	Execute the operation during trace stop.
Please set device data.	This is displayed when none of device data is set as a trace data.	Set device data.
Since the last line has data, a bit device cannot be copied.	This is displayed when a device is set in the last line.	Delete the device in the last line.
Since the last line has data, a word device cannot be copied.	This is displayed when a device is set in the last line.	Delete the device in the last line.
No bit devices were able to be copied.	This is displayed when the device entry monitors (bit device) are more than the word device setting field.	Delete the setup bit devices to gain the setting fields, or reduce the number of entered bit devices of entry device monitor (bit device) .
No word devices were able to be copied.	This is displayed when the device entry monitors (word device) are more than the word device setting field.	Delete the setup word devices to gain the setting fields, or reduce the number of entered bit devices of entry device monitor (word device) .

Closing the trace data setup screen

Use any of the following methods to close the trace data setup screen.

Methods to close the screen
Press the [SET] menu key.
Press the [CLOSE] menu key.
Press the left arrow key.
Press the [ESC] key on the software keyboard.

6.17.4.6 Trace Execution Screen

Outline

The trace is executed and the results are displayed on this screen.

Start Trace	This writes the trace conditions set by the On-board to the NC control unit automatically, and starts the trace.
Stop trace	This stops the trace.
Execute trigger	This enables the trigger to be executed forcibly from the screen. Also, this enables the trigger to be executed forcibly when the trigger point setup is "SPECIFIED DEVICES".
Suspend monitor	This performs the start or suspend the trace status monitor. When closing the "TRACE EXECUTION" screen during the trace, the monitor indications are stopped automatically. If you want to display them again, press the [START MONITOR] button.
Trace result	This displays the "trace result display" screen.

Note

- (1) If the trace is already started, an error occurs and the trace execution cannot start.
- (2) If the PLC stops, an error occurs and the trace cannot start.
- (3) If the trace data (trace conditions and trace results) are not correctly set up, the trace cannot start. (An error message appears.)
- (4) The trace conditions are retained in the NC at the start of tracing.
If you start the on-board and open the sampling trace screen, the screen shows the retained conditions even after the NC power OFF.
If you set the trace conditions, and then turn OFF the NC power before starting tracing, the previous conditions before the setting are applied.
- (5) If the trigger is not executed and exceeds the number of traces, the trace data will be cleared in the chronological order.
- (6) When the trace point is "EACH HIGH SCAN", the available bit devices for the trace data are limited to 8 points or lower. (If more than 8 point devices are set, the first 8 points are the target device for the trace.)
- (7) When the trace point is "TRACE DATA CHANGE", the available devices for the trace data are limited to 8 points for a bit device, and 2points for a word device.
- (8) The trace execution status is retained in the NC even after the NC power is turned OFF. Thus when you open the trace execution screen, tracing may already have started.
- (9) If the trigger is executed forcibly or the trigger is established with the set trigger point, the trace is executed for the number of times of trigger. Therefore, the number of executed traces may be below the total number depending on the timing at which the trigger is established.

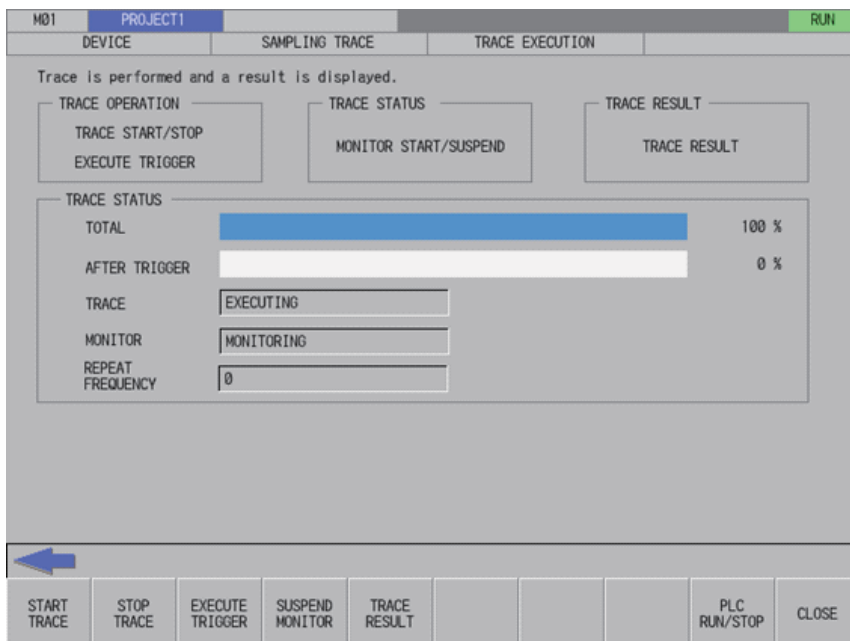

Screen display items

The following table describes the screen display items on the trace execution screen.

Item name	Display state
Connected NC name	This displays the name of the connected NC.
Current project No.	This displays the current project number.
Current project label	This displays the project label.
Alarm message	Alarm messages are displayed when alarms occur.
Left arrow key	This is displayed when enabled.
Software keyboard	This is displayed only when parameters are enabled.
Trace status	This displays the trace status with the scroll bar and percentage (ratio).
Monitor	This displays the trace monitor information.
Repeat frequency	This displays the number of repeated times during the trace execution.

Enabled/disabled state of menu keys

The following table describes the conditions upon which menu keys displayed on the trace execution screen are enabled/disabled.

The menu keys which are not described in the following table are always enabled.

Menu name	Condition upon which it is enabled/disabled
PLC RUN/STOP	Disabled when the function is restricted.

Status during screen displays

The following table describes the status when the trace execution screen is displayed.

Item name	Operation
Trace status (Total)	This displays "0%" .
Trace status (After trigger)	This displays "0%" .
Trace status (Trace)	This displays "EXECUTION FAILED".
Trace status (Monitor)	This displays "MONITORING".
Trace status (Repeat frequency)	This displays "0" .

Operation of key presses

The following table describes the operation of each menu key and the keys on the NC keyboard when pressed.

Item name	Operation
Left arrow key	Refer to "Closing the trace execution screen".
Start Trace	Refer to "Starting or stopping the trace".
Stop Trace	Refer to "Starting or stopping the trace".
Execute trigger	Refer to "Executing the trigger".
Start monitor/Suspend monitor	Refer to "Starting or suspending the trace status monitor".
Trace result	The trace result display screen is displayed.
PLC RUN/STOP	This displays the PLC RUN/STOP screen. Refer to "6.13.10 PLC RUN/STOP Popup Screen".
Close	Refer to "Closing the trace execution screen".

Starting or stopping the trace

■ For starting the trace

- (1) Press the menu key [START TRACE].
At the point of key pressed, setup trace condition is written to the NC and trace is started.
If the trace is already started, an error will occur and the trace cannot be executed.
- (2) The trace status is displayed as "EXECUTING" for the trace status (trace) and "MONITORING" for the trace status (monitor). Then, the trace status (total) is updated. Also the menu is updated to [SUSPEND MONITOR].
- (3) When the trace repeat is set, the trace status (repeat) is updated when executing trace the number of its times after trigger performed. Then, the total and after trigger returns to "0". The repeat continues until the trace stops.

■ For stopping the trace

- (1) Press the menu key [STOP TRACE] during the trace execution. At the point of key pressed, the trace is stopped.
- (2) The trace status (trace) becomes "SUSPEND" .

Executing the trigger

- (1) Press the menu key [EXECUTE TRIGGER] during the trace. At the point of the menu key pressed, the trigger (start point (0 point) of the trace execution) is recorded in the trace data.
- (2) The trace data (after trigger) is updated.

Starting or suspending the trace status monitor

■ Starting the trace status monitor

- (1) Press the menu key [START MONITOR] The menu key changes to [SUSPEND MONITOR], and the trace status monitor is started. The each type of information for trace status is continually-updated.
When closing the trace execution screen during the trace, and then displaying the trace execution screen again, although the trace status monitor is suspended, it can be started by the menu [START MONITOR].

■ Suspending the trace status monitor

- (1) Press the menu key [SUSPEND MONITOR] The menu key changes to [START MONITOR], and the trace status monitor is suspended. The each type of information for trace status stops the updates.

Trace execution

■ Abnormal operation

This information describes the details of error messages displayed on the trace execution screen and the corrective action thereof.

Error message	Error details	Remedy
The NC cannot execute during trace. Execute again after trace is completed.	This is displayed when the start trace is executed during trace.	Start the trace during trace stop.
No results information.	This is displayed when attempting to display trace result even though none trace has executed.	Display trace result after trace is completed.

Closing the trace execution screen

Use any of the following methods to close the trace execution screen.

Methods to close the screen
Press the [CLOSE] menu key.
Press the [TRACE RESULT] menu key.
Press the left arrow key.
Press the [ESC] key on the software keyboard.

6.17.4.7 Trace Result Display Screen

Outline

After the trace execution, the collected trace results can be displayed in chronological order. Also the output results can be written to the external devices in CSV file format.

Bit device	Displayed device field	This displays the trace result of bit device (connect/coil) on the upper side of screen. The changes of the devices are displayed in chronological order based on the trigger point as a base point "0".
	Count	This displays the number of traces at the cursor position in the bit device display field.
	Time	This displays the trace time (h:m:s) at the cursor position in the bit device display field.
	Disp. units	The displayed scale (number of traces to be displayed) can be changed with the following range. 10 (Default), 20, 50 and 100
Word device	Displayed device field	This displays the word devices (Current values) on the lower screen. The value change is displayed in chronological order based on the trigger point as a base point "0".
	Count	This displays the number of traces at the cursor position in the word device display field.
	Time	This displays the trace time (h:m:s) at the cursor position in the word device display field.
	Disp. units	16BIT DEC (Default) 16BIT HEX 32BIT DEC 32BIT HEX FLOAT (Single Precision) FLOAT (Double Precision) String To display the "32BIT" or "FLOAT (Single Precision)", upper or lower device is required to configure in the trace data setup. To display the "FLOAT (Double Precision)", set the specified device and three sequence devices.
Common	Device change	This moves the cursor between bit device display field and word device display field. The screen with the cursor can be scrolled to display the result details.
	Disp. units	This changes the unit to be displayed in the bit device display field or word device display field where the cursor is on.
	Adjust position	This changes the display position of other screen (e.g. word device display field) based on the cursor position of the screen with the cursor. (e.g. bit device display field).
	Line change (up)	This moves up the device with the cursor in the bit device display field or word device display field.
	Line change (down)	This moves down the device with the cursor in the bit device display field or word device display field.
	Page left feed	This moves the display position to the left for 1 page on the cursor located screen in the bit device display field or word device display field.
	Page right feed	This moves the display position to the right for 1 page on the cursor located screen in the bit device display field or word device display field.
	Left scroll	This moves the trace result to the left for 1 trace on the cursor positioned screen in the bit device display field or word device display field.
	Right scroll	This moves the trace result to the right for 1 trace on the cursor positioned screen in the bit device display field or word device display field.
Create CSV file	This enables the trace results to output (write) to the external file in CSV file format.	

Note

- (1) The trace results are cleared by the power OFF of NC.
- (2) When displaying the trace result with the repeat status, if more than 1 trace has been completed, the trace data completed last is displayed.
- (3) The trace results view displays the trace results collected by the NC.
 However, when the trace conditions and the trace results are obtained by the file read, the trace results obtained by the file read are displayed until the next trace is started. The trace results obtained by the file read are displayed even if the trace conditions are changed on trace count setup screen, trace point setup screen, trigger point setup screen or trace data setup screen.

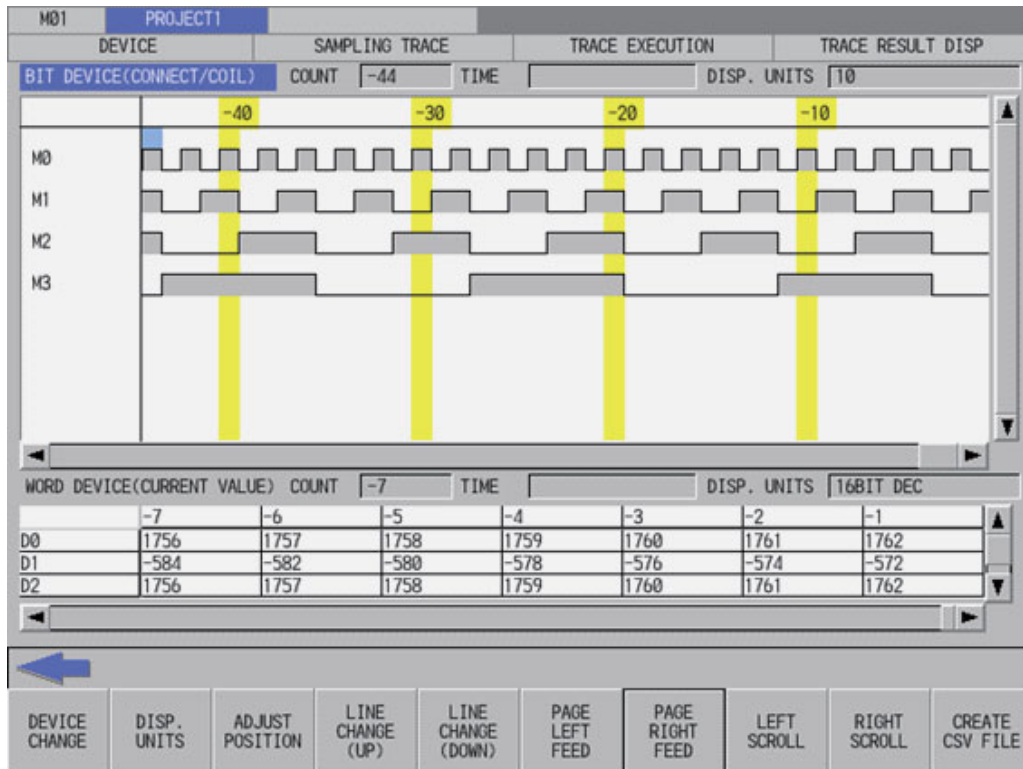

Screen display items

The following table describes the screen display items on the trace result display screen.

Item name	Display state
Connected NC name	This displays the name of the connected NC.
Current project No.	This displays the current project number.
Current project label	This displays the project label.
Alarm message	Alarm messages are displayed when alarms occur.
Left arrow key	This is displayed when enabled.
Software keyboard	This is displayed only when parameters are enabled.
Bit device	This displays 7 points of the trace result of bit devices (connect/coil). (with software keyboard: 4 points display) The changes of the devices are displayed in chronological order based on the trigger point as a base point "0".
Bit device (count)	This displays the number of traces at the cursor position in the displayed bit device field. The number of traces is indicated as the trigger position is "0", before trigger is negative, and after trigger is positive.
Bit device (time)	This displays the trace time (h:m:s) at the cursor position in the bit device display field.
Bit device (display units)	This displays the display scale (number of traces to be displayed) in the bit device display field.
Word device	This displays 3 points of the trace result of word devices. The changes of the values are displayed in chronological order based on the trigger point as a base point "0".
Word device (count)	This displays the number of traces at the cursor position in the displayed word device field. The number of traces is indicated as the trigger position is "0", before trigger is negative, and after trigger is positive.
Word device (time)	This displays the trace time (h:m:s) at the cursor position in the word device display field.
Word device (display units)	This displays the display scale in the word device display field.

Enabled/disabled state of menu keys

The following table describes the conditions upon which menu keys displayed on the trace result display screen are enabled/disabled.

The menu keys which are not described in the following table are always enabled.

Menu name	Condition upon which it is enabled/disabled
Page left feed	Disabled when there is no page to feed.
Page right feed	Disabled when there is no page to feed.
Left scroll	Disabled when there is no object to scroll.
Right scroll	Disabled when there is no object to scroll.

Status during screen displays

The following table describes the status when the trace result display screen is displayed.

Item name	Operation
Bit device	This displays the trace data of the bit device.
Bit device (count)	This displays the number of traces in the top of trace data.
Bit device (time)	This displays the trace time in the top of trace data.
Bit device (display units)	This displays "10".
Word device	This displays the trace data of the word device.
Word device (count)	This displays the number of traces in the top of trace data.
Word device (time)	This displays the trace time in the top of trace data.
Word device (display units)	This displays "16BIT DEC".

Operation of key presses

The following table describes the operation of each menu key and the keys on the NC keyboard when pressed.

Item name	Operation
Left arrow key	Refer to "Closing the trace result display screen".
Device change	This moves the cursor between bit device display field and word device display field. The screen with the cursor can be scrolled to display the result details.
Disp. units	This changes the unit to be displayed in the bit device display field or word device display field where the cursor is on. Bit device: 10 -> 20 -> 50 ->100 -> 10 Word device: 16BIT DEC -> 16BIT HEX -> 32BIT DEC -> 32BIT HEX -> Single Precision -> Double Precision -> String -> 16BIT DEC To display the "32BIT" or "FLOAT (Single Precision)", upper or lower device must be configured in the trace data setup. To display the "FLOAT (Double Precision)", set the specified device and three sequence devices.
Adjust position	This changes the display position of other screen based on the cursor position of the screen with the cursor .
Line change (up)	This moves up the cursor positioned device in the device display field.
Line change (down)	This moves down the cursor positioned device in the device display field.
Page left feed	This moves the display position to the left for 1 page on the cursor positioned screen in the device display field.
Page right feed	This moves the display position to the right for 1 page on the cursor positioned screen in the device display field.
Left scroll	This moves the trace result to the left for 1 trace on the cursor positioned screen in the device display field.
Right scroll	This moves the trace result to the right for 1 trace on the cursor positioned screen in the device display field.
Create CSV file	This displays the create CSV file screen.

Closing the trace result display screen

Use any of the following methods to close the trace result display screen.

Methods to close the screen
Press the [CREATE CSV FILE] menu key.
Press the left arrow key.
Press the [ESC] key on the software keyboard.

6.17.4.8 Create CSV File Screen

Outline

This is used to save the trace execution results in CSV file format.

Screen display items

The following table describes the screen display items on the create CSV file screen.

Item name	Display state
Connected NC name	This displays the name of the connected NC.
Current project No.	This displays the current project number.
Current project label	This displays the project label.
Alarm message	Alarm messages are displayed when alarms occur.
Left arrow key	This is displayed when enabled.
Software keyboard	This is displayed only when parameters are enabled.
Storage setting	This displays the path and file name where the CSV file is being stored.
Device storage method	This displays the storage method of the device being stored.
Storing method of a value	This displays the storage method of the device values being stored.

Enabled/disabled state of menu keys

The menu keys displayed on the create CSV file screen are always enabled.

Status during screen displays

The following table describes the status when the create CSV file screen is displayed.

Item name	Operation
Storage setting (path)	This is blank or displays the path that is specified in the storage setting.
Storage setting (file name)	This is blank or displays the file name that is specified in the storage setting.
Device storage method	This selects "HORIZONTALLY ARRANGE".
Storing method of a value	This selects "NOT SURROUNDS BY []".

Operation of key presses

The following table describes the operation of each menu key and the keys on the NC keyboard when pressed.

Item name	Operation
Left arrow key	Refer to "Closing the create CSV file screen".
Storage setting	This displays the storage setting screen.
Device storage method	The focus is applied to the device storage method. This changes the device storage method selection when the focus is already applied.
Storing method of a value	The focus is applied to the storing method of a value. This changes the storing method selection when the focus is already applied.
Execute	This stores the trace data using the storage method in CSV file format with the specified file name to the path set in the storage setting.
Close	Refer to "Closing the create CSV file screen".

Closing the create CSV file screen

Use any of the following methods to close the create CSV file screen.

Methods to close the screen
Press the [EXECUTE] menu key.
Press the [CLOSE] menu key.
Press the left arrow key.
Press the [ESC] key on the software keyboard.

6.17.4.9 Storage Setting Popup Screen

Outline

This displays a list of the trace execution result files stored in the external devices. Selects or creates a file to be stored. A project saved in GX Works2 format is not displayed in the list.

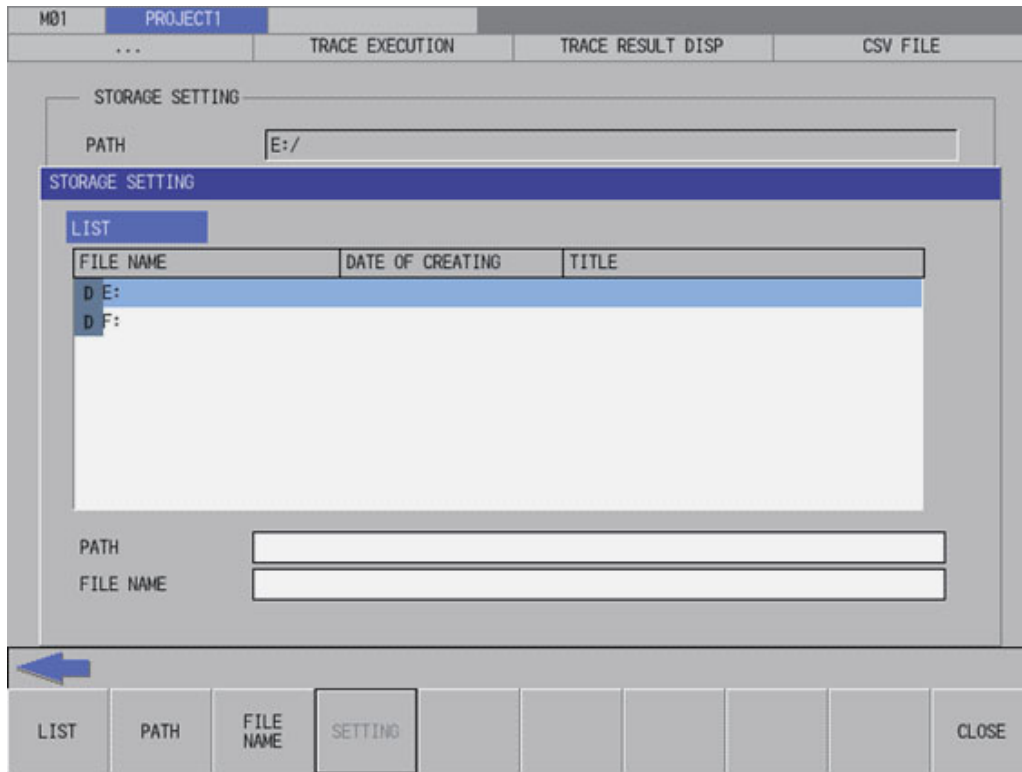

Screen display items

The following table describes the screen display items on the storage setting popup screen.

Item name	Display state
Connected NC name	This displays the name of the connected NC.
Current project No.	This displays the current project number.
Current project label	This displays the project label.
Alarm message	Alarm messages are displayed when alarms occur.
Left arrow key	This is displayed when enabled.
Software keyboard	This is displayed only when parameters are enabled.
List	This displays the directory and files of the specified path.
Path	This displays the path where the CSV file is stored. (The path can be entered.)
File name	This displays the file name selected in the list. (The file name can be entered.)

Enabled/disabled state of menu keys

The menu keys displayed on the storage setting popup screen are always enabled.

Status during screen displays

The following table describes the status when the storage setting popup screen is displayed.

Item name	Operation
List	Refer to "Displaying CSV files".
Path	This is blank or displays the path that is displayed in the List.
File name	This is blank or displays the file name that is selected in the list.

Displaying CSV file

This displays the directory and CSV file name stored directly under the root path of the default external device when the storage setting popup screen is displayed for the first time.

This displays the details of the path where the previously selected CSV file is stored when the storage setting popup screen is displayed after a storage setting is already performed. This displays path details directly under the root of the default external device when there is no specified path.

Operation of key presses

The following table describes the operation of each menu key and the keys on the NC keyboard when pressed.

Item name	Operation
Left arrow key	Refer to "Closing the storage setting popup screen".
List	The focus is applied to the list.
Path	The focus is applied to the path entry field.
File name	The focus is applied the file name entry field.
Setting	Refer to "Specifying CSV file".
Close	Refer to "Closing the storage setting popup screen".

Specifying CSV file

■ To directly input the path and file name

- (1) Press the [PATH] menu key , then the focus is moved to the path entry field. Enter the path where the CSV file is stored. This operation is not necessary if the save destination does not need to be changed.
- (2) Press the [FILE NAME] menu key to move the focus to the file name entry field. Enter the name for the CSV file.
- (3) After pressing the [SETTING] menu key closes the storage setting popup screen, the screen returns to the create CSV file screen. The selected path and file name are displayed in the select project of the create CSV file screen.

CSV files can be output to GX Developer projects. They cannot be output to GX Works2 projects.

■ To select a file name from the list

- (1) Press the [LIST] menu key to move the focus to the list. Use the up or down arrow key to select an existing fine name.
- (2) Pressing the [INPUT] menu key or pressing the [SETTING] menu key closes the storage setting popup screen and returns to the create CSV file screen. The selected path and file name are displayed in the select project of the create CSV file screen.

A project saved in GX Works2 format cannot be selected.

A GX Works2 project saved in one file format is not displayed in the list.

A GX Works2 project saved in work space format is displayed like a folder.

Closing the storage setting popup screen

Use any of the following methods to close the storage setting popup screen.

Methods to close the screen
Specify the storage destination.
Press the [CLOSE] menu key.
Press the left arrow key.
Press the [ESC] key on the software keyboard.

6.17.4.10 Trace File Read Screen

Outline

This displays a list of the trace files in the specified project, and reads the specified trace file.

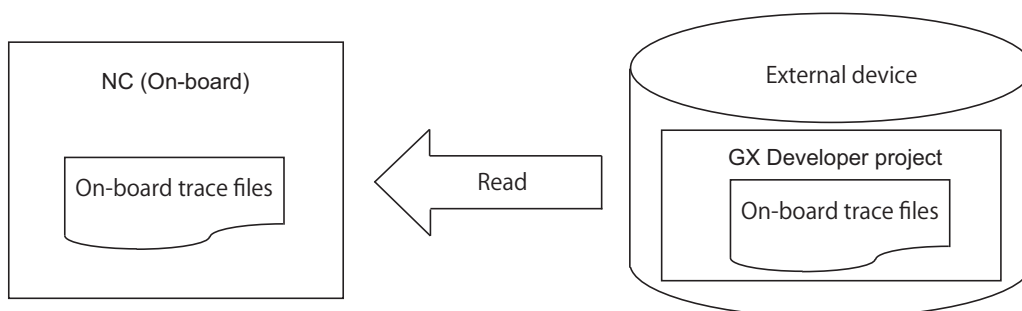

Read data	Trace conditions	Number of traces, trace points, trigger points, trace data, etc.
	Trace results	Trace data of the bit device and word device
Write data	Trace files of GX Developer projects or trace files written by On-board (Note) The format between GX Developer and the On-board are different.	

Note

- (1) The trace conditions are retained in the NC at the start of tracing, and they are retained even if the NC power is OFF. The trace results are discarded when the NC power is turned OFF.
- (2) Reading or writing the trace files are disabled during a trace.
- (3) The trace files of the trace conditions, which were created by GX Developer and are not supported with Mitsubishi Electric CNC, cannot be read.
- (4) The trace files that were created in different projects can be read, however, since the size and device range checks are performed at the trace execution, if the trace file is either the size over or out of the device range, an error message appears and the trace cannot be executed.
- (5) Trace files of GX Works2 projects cannot be input.

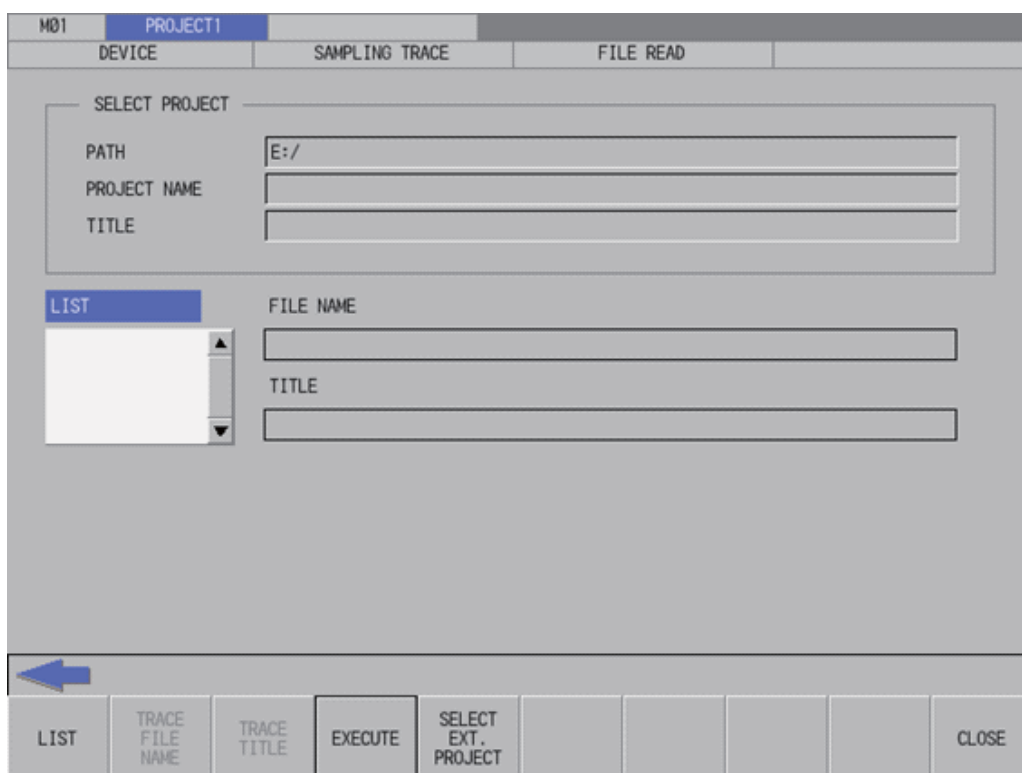

Screen display items

The following table describes the screen display items on the trace file read screen.

Item name	Display state
Connected NC name	This displays the name of the connected NC.
Current project No.	This displays the current project number.
Current project label	This displays the project label.
Alarm message	Alarm messages are displayed when alarms occur.
Left arrow key	This is displayed when enabled.
Software keyboard	This is displayed only when parameters are enabled.
Path	This displays the path where the project data is stored.
Project name	This displays the name of the specified project data.
Title	This displays the title set in the specified project data.
List	This displays the trace file stored in the specified project.
File name	This displays the selected file name.
Title	This displays the title set in the selected file.

Enabled/disabled state of menu keys

The following table describes the conditions upon which menu keys displayed on the trace file read screen are enabled/disabled.

The menu keys which are not described in the following table are always enabled.

Menu name	Condition upon which it is enabled/disabled
Execute	Enabled when the file name is not blank.

Status during screen displays

The following table describes the status when the trace file read screen is displayed.

Item name	Operation
Path	This displays the default path or the path of the selected project name.
Project name	This is blank or displays the selected project name.
List	This is blank or displays the trace files stored in the selected project.
File name	This is blank or displays the file name that is selected in the list.
Title	This is blank or displays the title that is set in the selected file in the list.

Operation of key presses

The following table describes the operation of each menu key and the keys on the NC keyboard when pressed.

Item name	Operation
Left arrow key	Refer to "Closing the trace file read screen".
List	This selects the list.
Execute	This obtains the specified trace file and then stores to the built-in PLC.
Select ext. project	This displays the select external project popup screen. Refer to "6.14.3 Select External Project Popup Screen".
Close	Refer to "Closing the trace file read screen".

Abnormal operation

This information describes the details of error messages displayed on the trace file read screen and the corrective action thereof.

Error message	Error details	Remedy
The NC cannot execute during trace. Execute again after trace is completed.	This is displayed when executing an operation during trace.	Execute the operation during trace stop.
The trace file of the trace condition not supporting it with MITSUBISHI CNC in the trace file made with GX Developer cannot be deleted.	This is displayed when reading a trace file of the trace condition that was created by GX Developer and is not supported with Mitsubishi Electric CNC.	Read a trace file of the trace condition which is supported with Mitsubishi Electric CNC.

Closing the trace file read screen

Use any of the following methods to close the trace file read screen.

Methods to close the screen
Execute the trace file read.
Press the [CLOSE] menu key.
Press the left arrow key.
Press the [ESC] key on the software keyboard.

6.17.4.11 Trace File Write Screen

Outline

This displays a list of the trace files in the specified project, and writes to the specified trace file.

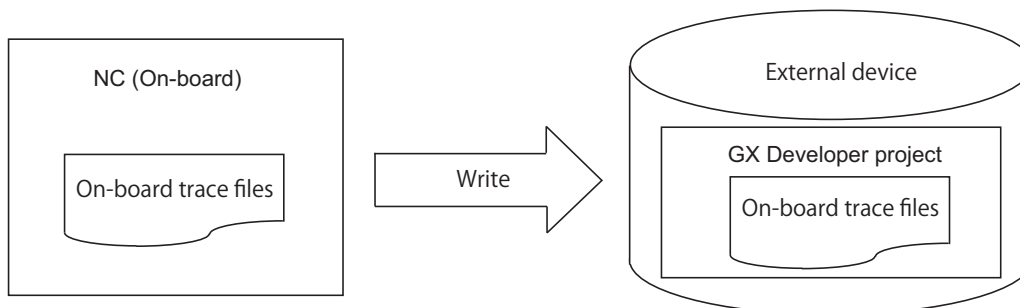

Write data	Trace conditions	Number of traces, trace points, trigger points, trace data, etc.
	Trace results	Trace data of the bit device and word device
Read data	The On-board original trace files	

Note

- (1) Reading or writing the trace files is disabled during a trace.
- (2) The trace files written by the On-board cannot be read by GX Developer. (incompatible)
- (3) Trace files cannot be written to GX Works2 projects.
- (4) When you execute file write after changing the trace conditions, only the trace conditions are written. If you change the trace conditions, start tracing, and then attempt to export the trace results to a file without displaying the results, only the trace conditions are output to a file. To have the trace results exported to a file, start tracing and then view the results before executing the file export.

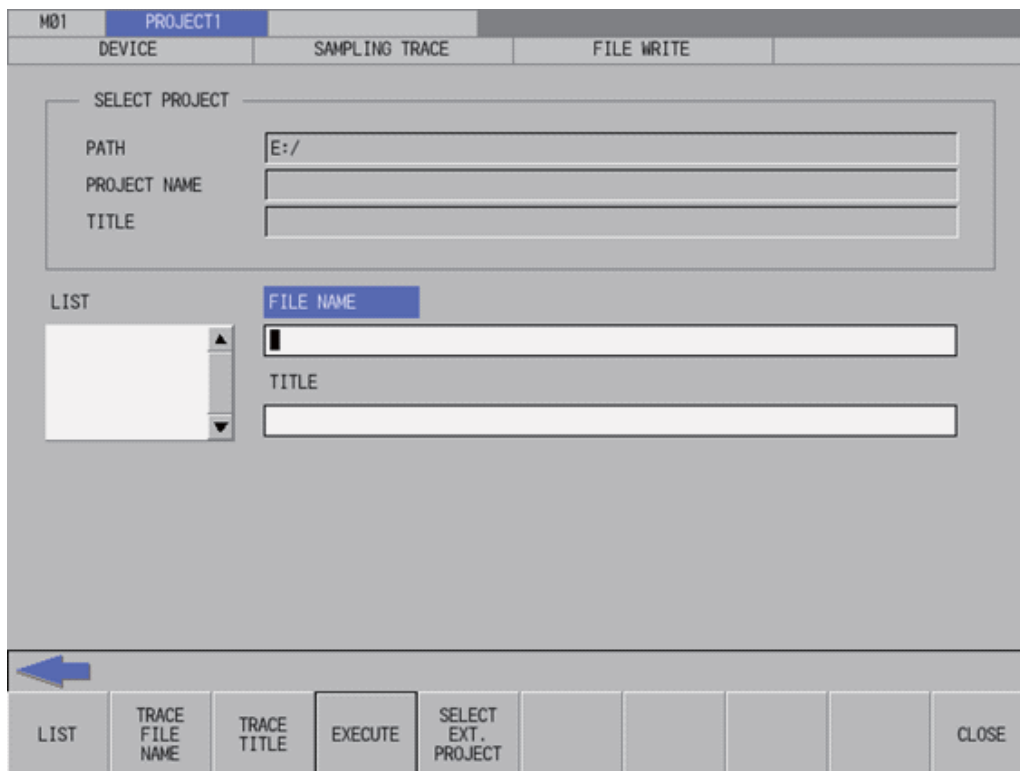

Screen display items

The following table describes the screen display items on the trace file write screen.

Item name	Display state
Connected NC name	This displays the name of the connected NC.
Current project No.	This displays the current project number.
Current project label	This displays the project label.
Alarm message	Alarm messages are displayed when alarms occur.
Left arrow key	This is displayed when enabled.
Software keyboard	This is displayed only when parameters are enabled.
Path	This displays the path where the project data is stored.
Project name	This displays the name of the specified project data.
Title	This displays the title set in the specified project data.
List	This displays the trace file stored in the specified project.
File name	This displays the selected file name.
Title	This displays the title set in the selected file.

Enabled/disabled state of menu keys

The following table describes the conditions upon which menu keys displayed on the trace file write screen are enabled/disabled.

The menu keys which are not described in the following table are always enabled.

Menu name	Condition upon which it is enabled/disabled
Execute	Enabled when the file name is not blank.

Status during screen displays

The following table describes the status when the trace file write screen is displayed.

Item name	Operation
Path	This displays the default path or the path of the selected project name.
Project name	This is blank or displays the selected project name.
List	This is blank or displays the trace files stored in the selected project.
File name	This is blank or displays the file name that is selected in the list.
Title	This is blank or displays the title that is set in the selected file in the list.

Operation of key presses

The following table describes the operation of each menu key and the keys on the NC keyboard when pressed.

Item name	Operation
Left arrow key	Refer to "Closing the trace file write screen".
List	This selects the list.
Execute	This obtains the trace file from the built-in PLC, and writes to the external device with the specified file name.
Select external project	This displays the select external project popup screen. Refer to "6.14.3 Select External Project Popup Screen".
Close	Refer to "Closing the trace file write screen".

Abnormal operation

This information describes the error messages and caution messages displayed on the trace file write screen.

Error message	Error details	Remedy
The NC cannot execute during trace. Execute again after trace is completed.	This is displayed when executing an operation during trace.	Execute the operation during trace stop.

Caution message	Details
Trace condition has been changed. Output only trace conditions to the file.	This message appears when you change the trace conditions after obtaining the trace results, and then execute the trace file write.

Closing the trace file write screen

Use any of the following methods to close the trace file write screen.

Methods to close the screen
Execute the trace file output.
Press the [CLOSE] menu key.
Press the left arrow key.
Press the [ESC] key on the software keyboard.

6.17.4.12 Trace File Delete Screen

Outline

This displays a list of the trace files in the specified project, and deletes the specified trace file.

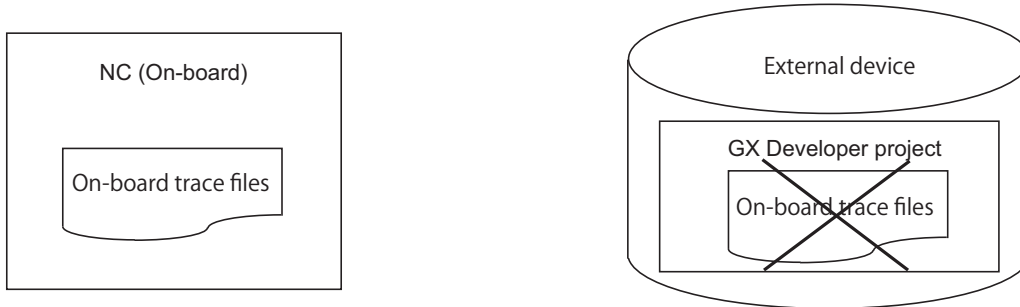

Delete data	Trace conditions	Number of traces, trace points, trigger points, trace data, etc.
	Trace results	Trace data of the bit device and word device
File format	Trace files written by the On-board.	

Note

- (1) Only the trace files written by the On-board can be deleted. The trace files created by GX Developer/GX Works2 cannot be deleted.

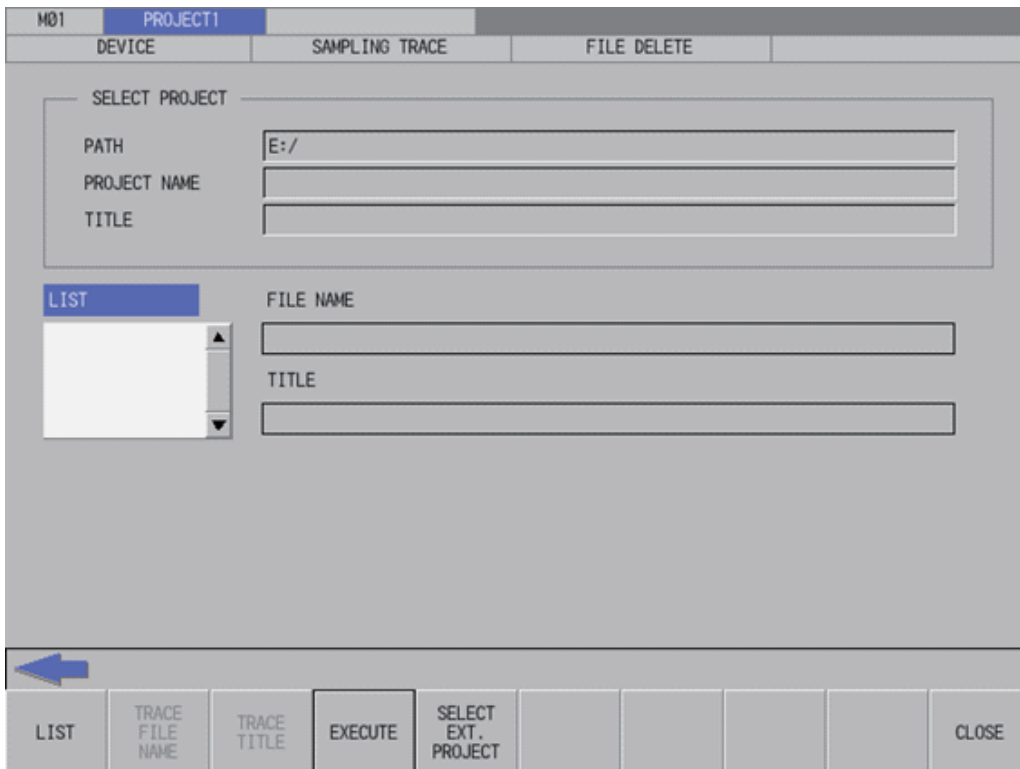

Screen display items

The following table describes the screen display items on the trace file delete screen.

Item name	Display state
Connected NC name	This displays the name of the connected NC.
Current project No.	This displays the current project number.
Current project label	This displays the project label.
Alarm message	Alarm messages are displayed when alarms occur.
Left arrow key	This is displayed when enabled.
Software keyboard	This is displayed only when parameters are enabled.
Path	This displays the path where the project data is stored.
Project name	This displays the name of the specified project data.
Title	This displays the title set in the specified project data.
List	This displays the trace file stored in the specified project.
File name	This displays the selected file name.
Title	This displays the title set in the selected file.

Enabled/disabled state of menu keys

The following table describes the conditions upon which menu keys displayed on the trace file delete screen are enabled/disabled.

The menu keys which are not described in the following table are always enabled.

Menu name	Condition upon which it is enabled/disabled
Execute	Enabled when the file name is not blank.

Status during screen displays

The following table describes the status when the trace file delete screen is displayed.

Item name	Operation
Path	This displays the default path or the path of the selected project name.
Project name	This is blank or displays the selected project name.
List	This is blank or displays the trace files stored in the selected project.
File name	This is blank or displays the file name that is selected in the list.
Title	This is blank or displays the title that is set in the selected file in the list.

Operation of key presses

The following table describes the operation of each menu key and the keys on the NC keyboard when pressed.

Item name	Operation
Left arrow key	Refer to "Closing the trace file delete screen".
List	This selects the list.
Execute	This reads the specified trace file.
Select external project	This displays the select external project popup screen. Refer to "6.14.3 Select External Project Popup Screen".
Close	Refer to "Closing the trace file delete screen".

Abnormal operation

This information describes the details of error messages displayed on the trace file delete screen and the corrective action thereof.

Error message	Error details	Remedy
The NC cannot execute during trace. Execute again after trace is completed.	This is displayed when executing an operation during trace.	Execute the operation during trace stop.

Closing the trace file delete screen

Use any of the following methods to close the trace file delete screen.

Methods to close the screen
Execute trace file deletion.
Press the [CLOSE] menu key.
Press the left arrow key.
Press the [ESC] key on the software keyboard.

6.17.4.13 Example of Trace File Write

Outline

There are following writing patterns for a trace file.

- ♦ Write the trace conditions only
- ♦ Write the trace conditions and trace results

The writing pattern is determined by the trace file of the NC (on-board) and screen operation.

Initial status

Trace results do not exist and only initialized trace conditions are stored in the initial state NC (On-board). When a file is written in this state, only the trace conditions are written to a trace file.

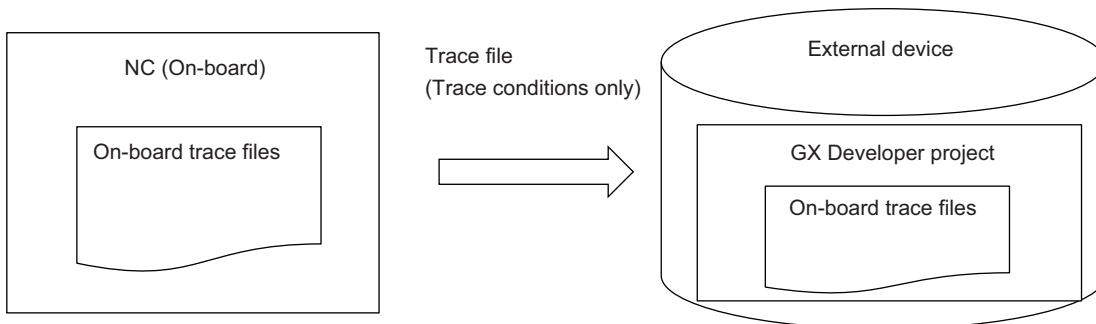

After starting a trace

Sampling trace is executed according to the trace conditions, and trace results are created by trace start operations. When a file is written in this state, only the trace conditions are written to a trace file, because trace results have not been displayed.

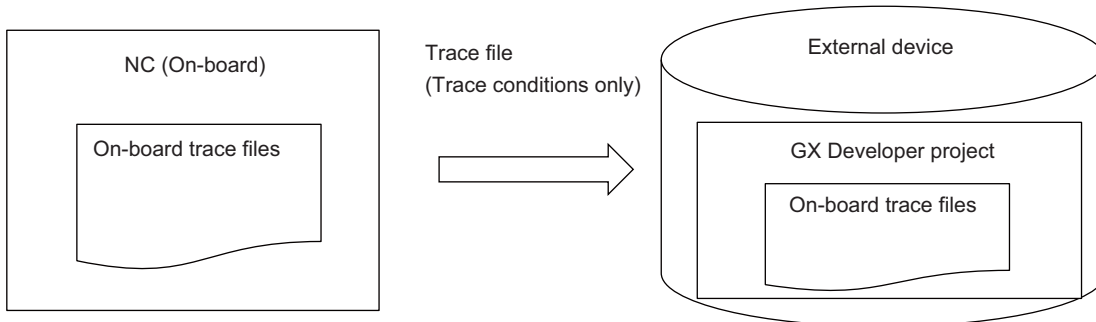

Start of trace -> After displaying results

When you open the trace result display screen by trace start operations, the results of currently performed trace are displayed. When a file is written in this state, the trace conditions and the results of currently performed trace are output in a form of trace file (trace conditions and trace results).

The same applies to Start of trace -> End of trace -> After displaying results.

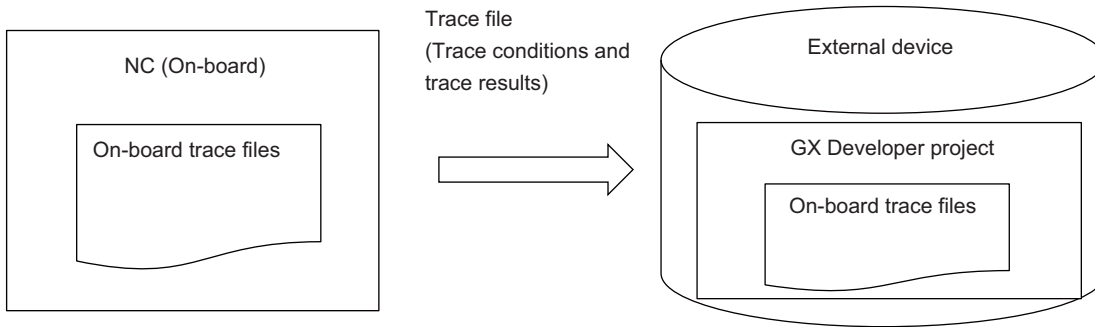

End of trace -> After displaying results -> Trace condition change

Trace results for file write are discarded when you change the trace conditions.

When a file is written in this state, a message appears saying that only the trace conditions are written, and only the trace conditions are written to a trace file.

Note that the previous trace conditions and trace results before change are displayed if the trace result screen is displayed.

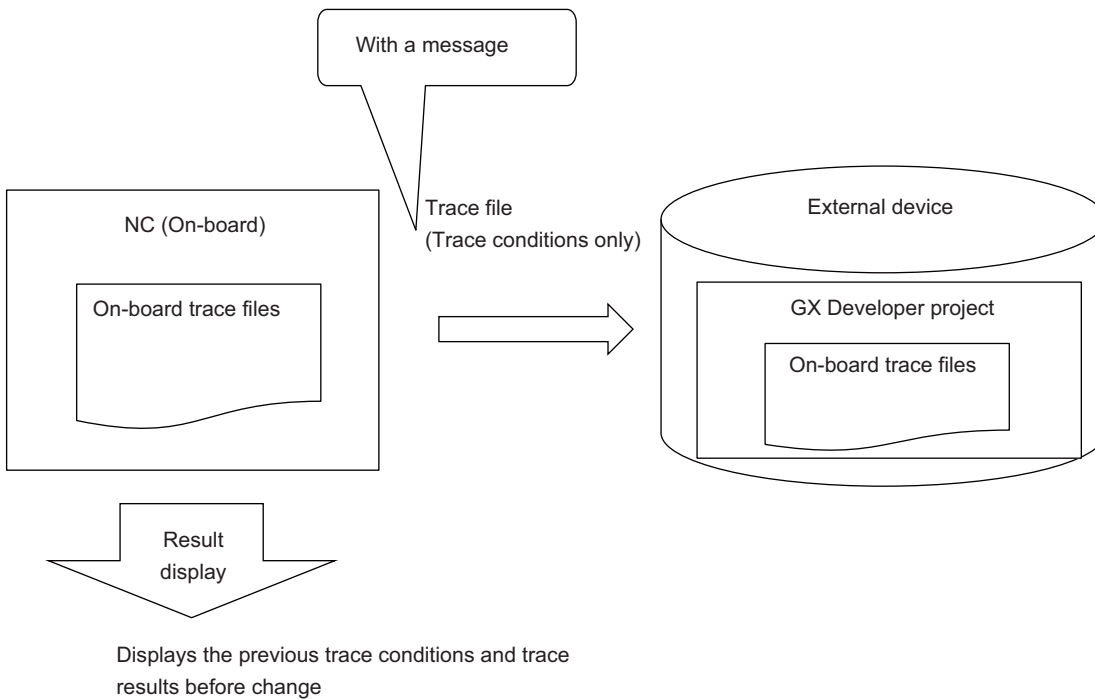

End of trace -> After displaying results -> Start of trace

The obtained trace results are discarded when the trace start is performed. When a file is written in this state, only the trace conditions are written to a trace file, because trace results have not been displayed.

When you open the trace result display screen, the results of currently performed trace are displayed.

The file cannot be written after displaying the results because trace is being executed.

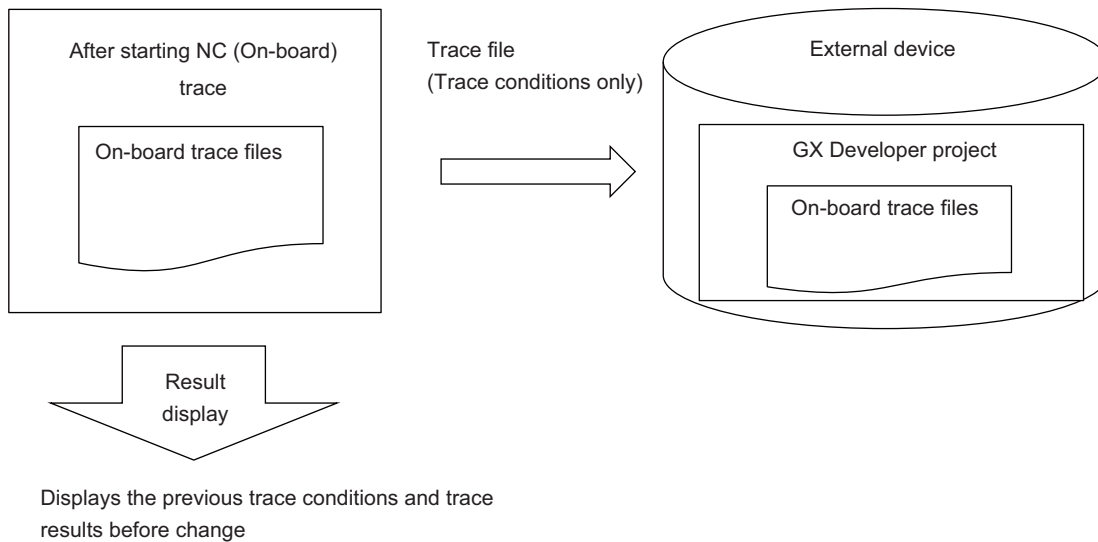

Trace read

If you use trace read to import a trace file into the NC, and perform the above-described screen operations to do file write, the resulting trace file is equivalent to that made through the above-described screen operations.

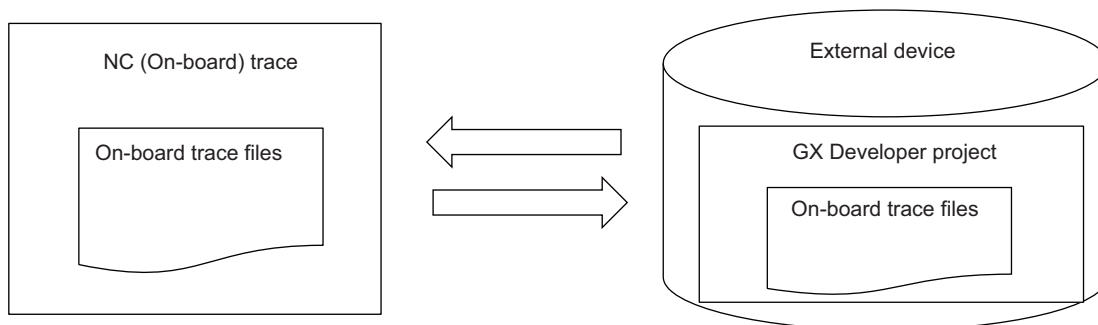

6.18 Parameter Menus

6.18.1 Parameter Main Screen

6.18.1.1 Outline

This displays menus for parameters that control PLC operation.

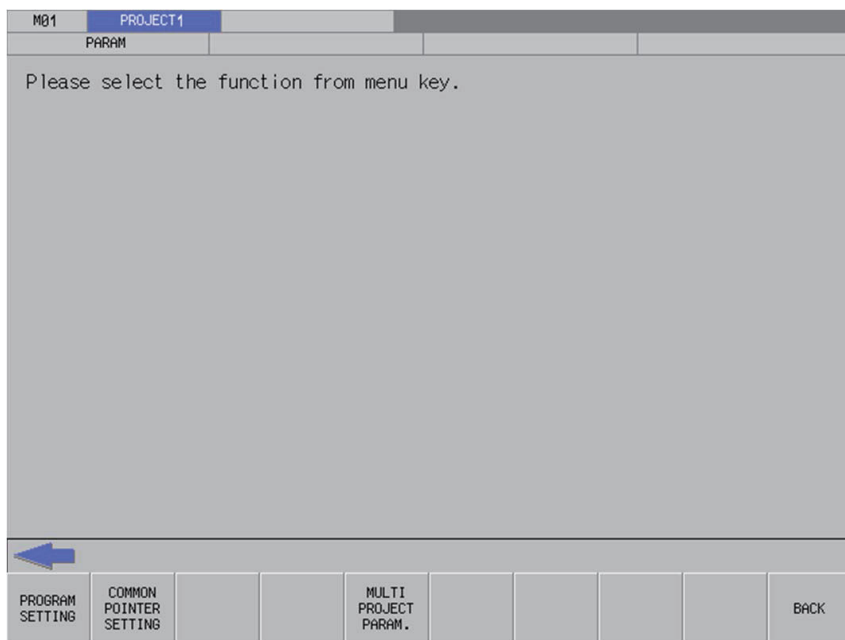

6.18.1.2 Screen Display Items

The following table describes the screen display items on the parameter main screen.

Item name	Display state
Connected NC name	This displays the name of the connected NC.
Current project No.	This displays the current project number.
Current project label	This displays the project label.
Alarm message	This is displayed when alarms occur.
Left arrow key	This is displayed when enabled.
Software keyboard	This is displayed only when parameters are enabled.

6.18.1.3 Enabled/Disabled State of Menu Keys

The menu keys displayed on the parameter main screen are always enabled.

6.18.1.4 Operation of Key Presses

The following table describes the operation of each menu key and the keys on the NC keyboard when pressed.

Item name	Operation
Left arrow key/return menu key	These transition to the main menu.
Various menu keys	This displays the specified screen.

6.18.2 Program Settings Screen

6.18.2.1 Outline

The execution order of programs when running multiple PLCs stored in the current project on the NC can be specified. Programs are executed in order from the lowest number configured in the set list as illustrated in the following diagram. Current settings are displayed, but cannot be changed when operation mode is GX Works2.

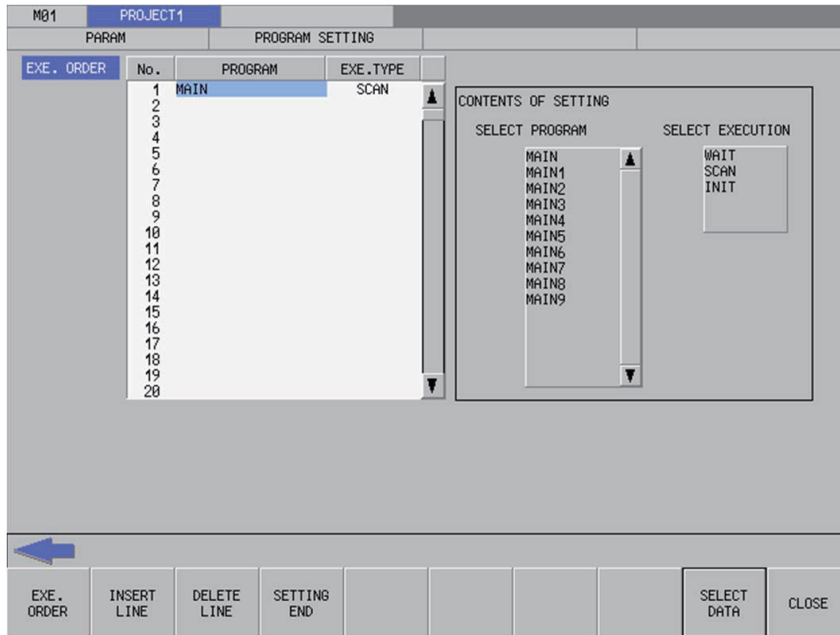

6.18.2.2 Screen Display Items

The following table describes the screen display items for the program settings screen.

Item name	Display state
Connected NC name	This displays the name of the connected NC.
Current project No.	This displays the current project number.
Current project label	This displays the project label.
Alarm message	This is displayed when alarms occur.
Left arrow key	This is displayed when enabled.
Software keyboard	This is displayed only when parameters are enabled.
Execution sequence	The details of the program settings are displayed.
Contents of setting	This displays the file names of sequence programs and the selected type of execution.

6.18.2.3 Enabled/Disabled State of Menu Keys

The following table describes the conditions upon which menu keys displayed on the program settings screen are enabled/disabled.

The menu keys which are not described in the following table are always enabled.

Menu name	Condition upon which it is enabled/disabled
Inserting lines	Enabled when the focus is set on the execution sequence. Hidden when operation mode is GX Works2.
Deleting lines	Enabled when the focus is set on the execution sequence. Hidden when operation mode is GX Works2.
Complete settings	Hidden when operation mode is GX Works2.
Select data	Hidden when operation mode is GX Works2.

6.18.2.4 Status during Screen Displays

The following table describes the status when displaying the program settings screen.

Item name	Operation
Execution sequence	This displays the details of the program settings for the current project.
Contents of setting	This displays the selectable execution type and files names of sequence programs stored in the current project.

6.18.2.5 Operation of Key Presses

The following table describes the operation of each menu key and the keys on the NC keyboard when pressed.

Item name	Operation
Left arrow key	Refer to "6.18.2.8 Closing the Program Settings Screen".
Execution sequence	This sets the focus to the execution sequence.
Inserting lines	This inserts one blank line at the cursor position in the execution sequence. Lines are not inserted when data is already set at the last line in the set list.
Deleting lines	This deletes one line at the cursor position in the execution sequence and moves remaining data up one line.
Complete settings	Refer to "6.18.2.6 Setting the Program Execution Sequence".
Close	Refer to "6.18.2.8 Closing the Program Settings Screen".

6.18.2.6 Setting the Program Execution Sequence

- (1) Press the [EXE. ORDER] menu key to select the execution order.
- (2) Use the up/down arrow keys, "PageUp" key, and "PageDown" key to move the cursor to the position in the program name column to set the execution sequence for programs.
- (3) Press the [INPUT] key. Pressing the [INPUT] key selects the select program field of Contents of setting.
- (4) Use the up/down arrow keys, "PageUp" key, and "PageDown" key to select the program for which you want to set the program execution sequence.
- (5) Press the [INPUT] key. Pressing the [INPUT] key displays the name of the program selected in the select program field at the cursor position in the execution order.
[WAIT] is automatically set for the execution type in the line where the program is displayed.
- (6) Use the right arrow key to move the cursor from the program name column to the execution type column.
- (7) Press the [INPUT] key. Pressing the [INPUT] key selects the selection execution field of Contents of setting.
- (8) Use the up/down arrow keys, Page Up key, and Page Down key to select the execution type for the program.
- (9) Press the [INPUT] key. Pressing the [INPUT] key displays the execution type selected in the select execution field at the cursor position in the execution order.
- (10) Repeat step (3) to step (9) to set the execution sequence for all programs.
- (11) Press the [COMPLETE SETTINGS] menu key after all settings are complete.

6 Explanation of Built-in Editing Function (PLC On-board)

6.18 Parameter Menus

(12) The following message screen displays when the PLC is running.

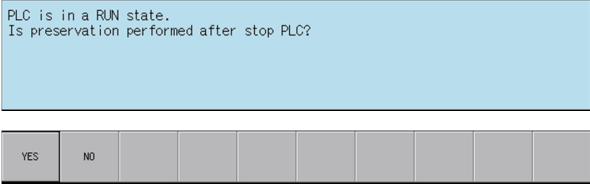

- (a) Pressing the [NO] menu key displays the following error message. Closing the error message returns to the program settings screen.

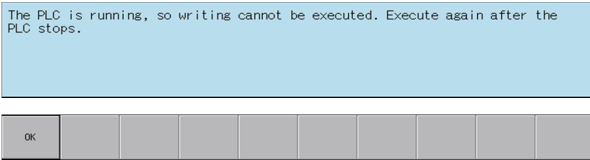

- (b) Pressing the [YES] menu key closes the message screen and executes the program settings. The following message displays after the settings are complete.

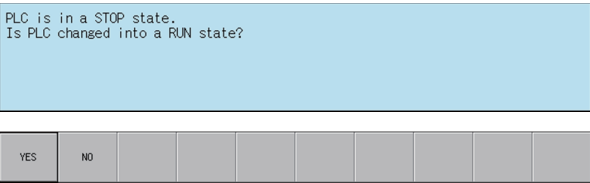

Press the [YES] menu key restarts the PLC stopped to complete the settings and closes the message screen. Pressing the [NO] menu key closes the message screen without restarting the PLC.

(13) The complete message displays if the program settings complete without error. Closing the complete message returns the system to the program settings screen.



6.18.2.7 Abnormal operation

This information describes the details of error messages displayed on the program settings screen and the corrective action thereof.

Error message	Error details	Remedy
Failed to obtain the maximum number of registration programs. Please set it within the PLC specified range.	This message appears when you use the PLC on-board of version C0 or later to connect to the NC of version B2 or earlier.	Update the connected NC to version C0 or later. Note however that the program setting can be executed within the PLC specification ranges.

6.18.2.8 Closing the Program Settings Screen

Use any of the following methods to close the program settings screen.

Methods to close the screen
Press the [CLOSE] menu key.
Press the left arrow key.
Press the [ESC] key on the software keyboard.

6.18.3 Common Pointer Settings Screen

6.18.3.1 Outline

The initial P number can be checked for common pointers (pointers used to call subroutines from all programs) in the current project.

Note

- (1) Configure common pointers using GX Developer/GX Works2 in range between P0 to P4095.
- (2) The initial P number in common pointers is enabled when executing multiple programs.
- (3) When executing single programs, leave this blank (press the [SET] button without configuring any settings).
- (4) If the common pointer setting is left blank (not configuring any settings) when using multiple programs, this is set to the default of P1800 or higher.

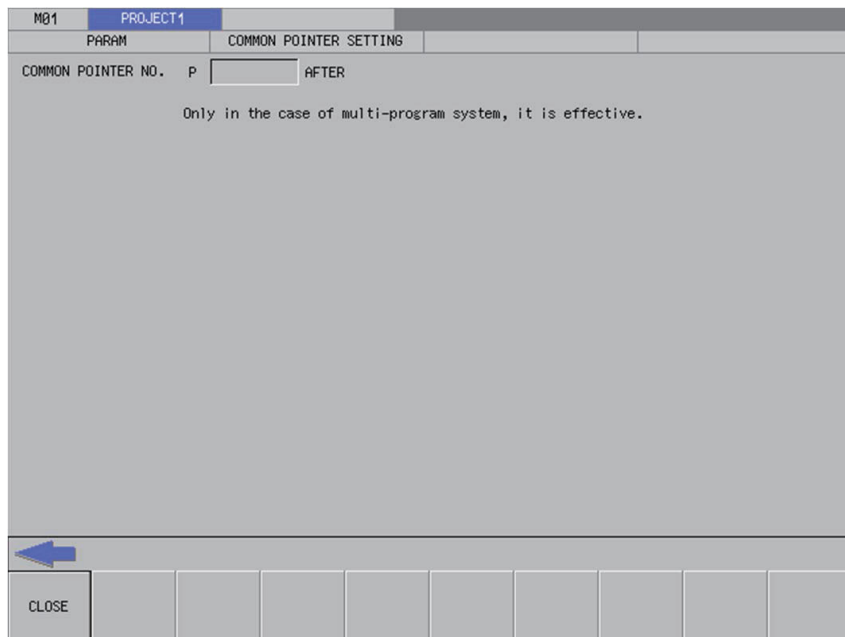

6.18.3.2 Screen Display Items

The following table describes the screen display items for the common pointer settings screen.

Item name	Display state
Connected NC name	This displays the name of the connected NC.
Current project No.	This displays the current project number.
Current project label	This displays the project label.
Alarm message	This is displayed when alarms occur.
Left arrow key	This is displayed when enabled.
Software keyboard	This is displayed only when parameters are enabled.
Common pointer No.	This displays the initial P number for common pointers.

6.18.3.3 Enabled/Disabled State of Menu Keys

The menu keys displayed on the common pointer settings screen are always enabled.

6.18.3.4 Status during Screen Displays

The following table describes the status when displaying the common pointer settings screen.

Item name	Operation
Common pointer No.	This is the default focus position when the screen is displayed. This displays the initial P number for common pointers set to the project specified for operation.

6.18.3.5 Operation of Key Presses

The following table describes the operation of each menu key and the keys on the NC keyboard when pressed.

Item name	Operation
Left arrow key	Refer to "6.18.3.6 Closing the Common Pointer Screen".
Close	

6.18.3.6 Closing the Common Pointer Screen

Use any of the following methods to close the common pointer settings screen.

Methods to close the screen
Press the [CLOSE] menu key.
Press the left arrow key.
Press the [ESC] key on the software keyboard.

6.18.4 Multiple Project Parameters Main Screen

6.18.4.1 Outline

This configures parameters for multiple projects.

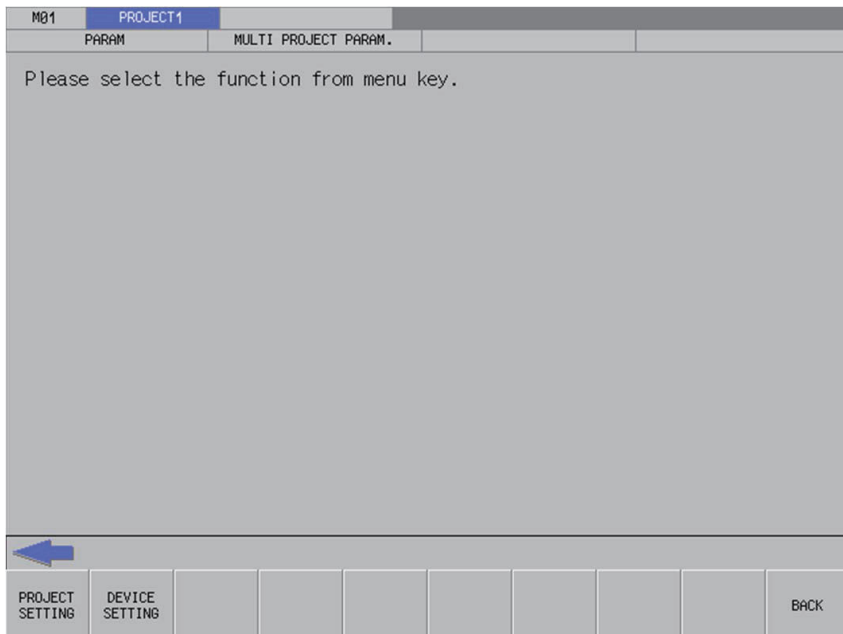

6.18.4.2 Screen Display Items

The following table describes the screen display items on the multiple project main screen.

Item name	Display state
Connected NC name	This displays the name of the connected NC.
Current project No.	This displays the current project number.
Current project label	This displays the project label.
Alarm message	This is displayed when alarms occur.
Left arrow key	This is displayed when enabled.
Software keyboard	This is displayed only when parameters are enabled.

6.18.4.3 Enabled/Disabled State of Menu Keys

The menu keys displayed on the multiple project parameters main screen are always enabled.

6.18.4.4 Operation of Key Presses

The following table describes the operation of each menu key and the keys on the NC keyboard when pressed.

Item name	Operation
Left arrow key/return menu key	This transitions to the parameter main screen.
Various menu keys	This displays the specified screen.

6.18.5 Project Settings Screen

6.18.5.1 Outline

This enables parameters for operating multiple projects to be configured such as the maximum project No. and the project to execute.

M01 PROJECT1

PARAM MULTI PROJECT PARAM. PROJECT SETTING

Please set the parameters for the operation of the multi-project.

MAX PROJECT No. 01 02 03 04 05 06

LIST

PROJECT No.	01	02	03	04	05	06
PROJ. RATIO (%)	100	0	0	0	0	0
EXECUTE PROJECT	ON	OFF	OFF	OFF	OFF	OFF
EXE.ORDER	1	2	3	4	5	6

←

MAX PROJECT No. LIST SET CLOSE

6.18.5.2 Screen Display Items

The following table describes the screen display items for the project settings screen.

Item name	Display state
Connected NC name	This displays the name of the connected NC.
Current project No.	This displays the current project number.
Current project label	This displays the project label.
Alarm message	This is displayed when alarms occur.
Left arrow key	This is displayed when enabled.
Software keyboard	This is displayed only when parameters are enabled.
Maximum project No.	This displays the number of usable projects.
List	This displays the project ratio, execution project, and the execution sequence.

6.18.5.3 Enabled/Disabled State of Menu Keys

The menu keys displayed on the project settings screen are always enabled.

6.18.5.4 Status during Screen Displays

The following table describes the status when displaying the project settings screen.

Item name	Operation
Maximum project No.	This is the default focus position when the screen is displayed. This displays the highest project number that can be used within the project numbers set in the NC.
List	This displays the project ratio, execution project, and execution sequence set for each project.

6.18.5.5 Operation of Key Presses

The following table describes the operation of each menu key and the keys on the NC keyboard when pressed.

Item name	Operation
Left arrow key	Refer to "6.18.5.10 Closing the Project Settings Screen".
Maximum project No.	This sets the focus to the maximum project No. This changes the maximum project no. selection when the focus is already set.
List	This selects the list.
Settings	Refer to "6.18.5.9 Configuring the Project Settings".
Close	Refer to "6.18.5.10 Closing the Project Settings Screen".

6.18.5.6 Setting the Project Ratio

Rules for project ratio settings

The following table describes the rules and precautions regarding the configuration of project ratio settings using the PLC On-board.

Setting Rules and Precautions
Set the total ratios for all usable projects so that it is no more than 100.
The ratio cannot be set for projects that are not usable.
The size of each setting should be 4 steps/byte. (Fractions are added to project 1 to prevent multiples of 4.)
The size of the project ration cannot be set to a value less than the size of the data and sequence programs currently stored.

Entering the project ratio

- (1) Press the [LIST] menu to select the list.
- (2) Use the up and down arrow keys to move to a position in the project ratio column in the list.
- (3) Press the [INPUT] key to display the label input field at the bottom of the list and move the focus.



- (4) Enter the project ratio in accordance with the previously described rules and precautions, and then press the [INPUT] key. Press the INPUT key to close the project ratio input field. The entered project ratio is displayed at the cursor position in the list.

Deleting ratios

- (1) Press the [LIST] menu to select the list.
- (2) Use the up and down arrow keys to move to a position in the project ratio column in the list.
- (3) Press the [DELETE] menu key. Pressing the [DELETE] key deletes the project ratio at the cursor position. The project ratio at the deleted position becomes 0%.

6.18.5.7 Setting Execution Projects

Rules for execution project settings

The following table describes the rules and precautions regarding the configuration of execution project settings using the PLC On-board.

Setting Rules and Precautions
Projects that are not usable will not execute even if set to ON.
You cannot turn off all projects.

Entering the execution projects

- (1) Press the [LIST] menu to select the list.
- (2) Use the up and down arrow keys to move to the position of the line for the project in the list for which the execution is to be set.
- (3) Refer to "Setting selection items in lists" in "Operation Key List :Screen Items (Control)". Pressing the [INPUT] key while the cursor is in the execution project display field changes the display between [ON] and [OFF].

PROJECT No.	01	02	03	04	05	06
PROJ. RATIO (%)	100	0	0	0	0	0
EXECUTE PROJECT	ON	OFF	OFF	OFF	OFF	OFF
EXE.ORDER	1	2	3	4	5	6

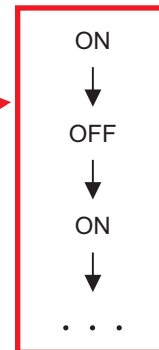

- (4) In accordance with the previously described rules and precautions, select [ON] to execute the project at the set position or select [OFF] to not execute the project.

6.18.5.8 Setting the Execution Sequence

Rules for execution sequence settings

The following table describes the rules and precautions regarding the configuration of execution sequence settings using the PLC On-board.

Setting Rules and Precautions
The sequence cannot be set for projects that are not usable.
The same execution sequence number cannot be set to multiple projects for which the execution project is set to [ON].
The execution sequence is ignored if the execution project is set to [OFF].
The execution sequence when the execution project is set to [OFF] is automatically set to the next sequence number from the execution end position of executing projects set in the NC.
Projects for which the execution project is set to [ON] are executed in order from the lowest number set in the execution sequence.

Entering the execution sequence

- (1) Press the [LIST] menu to select the list.
- (2) Use the up and down arrow keys to move to the position of the line for the execution sequence to be set in the list.
- (3) Refer to "Setting selection items in lists" in "Operation Key List :Basic Operation Keys." Pressing the [INPUT] key while the cursor is in the execution sequence display field changes the display of the sequence between one to the maximum project no. from the lowest number.

PROJECT No.	01	02	03	04	05	06
PROJ. RATIO (%)	100	0	0	0	0	0
EXECUTE PROJECT	ON	OFF	OFF	OFF	OFF	OFF
EXE.ORDER	1	2	3	4	5	6

1
↓
2
↓
...
↓
8
↓
1
...

- (4) In accordance with the previously described rules and precautions, select the execution sequence for the project at the set position.

6.18.5.9 Configuring the Project Settings

Normal operation

- (1) Press the [MAX PROJECT No.] and select the number of projects to use.
- (2) Refer to "Setting the Project Ratio" and enter the project ratio.
- (3) Refer to "Setting Execution Projects" and select the execution projects.
- (4) Refer to "Setting the Execution Sequence" and enter the execution sequence.
- (5) Press the [SET] menu key.
- (6) The following message screen displays if the project settings complete without error. Closing the message screen closes the project settings screen and returns to the multiple project parameters screen.

Completed.
To enable the setting, please restart the NC.



Abnormal operation

This information describes the details of error messages displayed on the project settings screen and the corrective action thereof.

Error message	Error details	Remedy
The project ratio is not 100%.	This is displayed if the set project ratio is less than or more than 100%.	Set the ratios so that the total ratio is 100%.
The project ratio is less than the size of PLC data.	This is displayed if the set project ratio is less than the storage size of PLC data.	Format the PLC data storing the project ratio or set the ratio larger than the size of the PLC data.
All execution projects are turned off.	This is displayed if all execution projects are turned off.	Turn on at least one of the execution projects.
Execution projects are set with the same execution sequence number.	This is displayed if used projects are set with the same execution sequence number.	Set each used project with a different execution sequence number.

6.18.5.10 Closing the Project Settings Screen

Use any of the following methods to close the project settings screen.

Methods to close the screen
Press the [SET] menu key to complete the project settings without errors.
Press the [CLOSE] menu key.
Press the left arrow key.
Press the [ESC] key on the software keyboard.

6.18.6 Device Settings Screen

6.18.6.1 Outline

This enables the number of devices used in multiple projects to be set.

PROJECT1

PARAM MULTI PROJECT PARAM. DEVICE SETTING

Please set the number of the device to be used for each project.

	01	02	03	04	05	06	COMMON	TOTAL	REMAIN
M	20480	20480	20480	20480	20480	20480	0	122880	0
L	512	512	256	256	256	256	0	2048	0
B	20480	20480	18432	18432	18432	18432	0	114688	0
F	0	0	0	0	0	0	2048	2048	2048
SB	512	512	256	256	256	256	0	2048	0
V	256	256	128	128	128	128	0	1024	0
S	0	0	0	0	0	0	0	0	0
T	1024	1024	512	512	512	512	0	4096	0
ST	64	64	32	32	32	32	0	256	0
C	256	256	128	128	128	128	0	1024	0
D	2048	2048	1024	1024	1024	1024	0	8192	0
W	8192	8192	2048	2048	2048	2048	0	24576	0
SW	512	512	256	256	256	256	0	2048	0
TOTAL	15.7K	15.7K	7.6K	7.6K	7.6K	7.6K			

←

SET CLOSE

6.18.6.2 Screen Display Items

The following table describes the screen display items for the device settings screen.

Item name	Display state
Connected NC name	This displays the name of the connected NC.
Current project No.	This displays the current project number.
Current project label	This displays the project label.
Alarm message	This is displayed when alarms occur.
Left arrow key	This is displayed when enabled.
Software keyboard	This is displayed only when parameters are enabled.
List	This displays the number of devices and the number of common M devices set in projects.

6.18.6.3 Enabled/Disabled State of Menu Keys

The menu keys displayed on the device settings screen are always enabled.

6.18.6.4 Status during Screen Displays

The following table describes the status when displaying the device settings screen.

Item name	Operation
List	This displays the status of the number of devices for projects set in the NC.

6.18.6.5 Operation of Key Presses

The following table describes the operation of each menu key and the keys on the NC keyboard when pressed.

Item name	Operation
Left arrow key	Refer to "6.18.6.8 Closing the Device Settings Screen".
Maximum project No.	This sets the focus to the maximum project No. This changes the maximum project no. selection when the focus is already set.
Settings	Refer to "6.18.6.7 Configuring Device Settings".
Close	Refer to "6.18.6.8 Closing the Device Settings Screen".

6.18.6.6 Entering the Number of Devices

Rules for setting the number of devices

The following table describes the rules and precautions regarding the setting of the number of devices using the PLC On-board.

Setting Rules and Precautions
Set the number of devices in intervals of 16 (multiples of 16).
Up to 61,440 points can be set for each device, but the number of devices cannot be set over the maximum number of all devices.
The total number of devices that can be used in one project is 29,000 words.
The total number of devices set in a project cannot be changed.
Changing the number of devices clears the number of common M devices.
The number of devices can be set to projects that are not used, but this decreases the number of devices that can be set for used projects.

Entering the number of devices

- (1) Use the cursor keys to move the position to set the number of devices.
- (2) Press the [INPUT] key to display the device number entry field at the bottom of the list and move the focus.

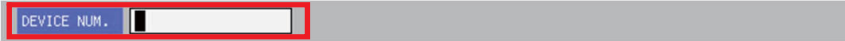

- (3) Enter the number of devices in accordance with the previously described rules and precautions, and then press the [INPUT] key. Press the INPUT key to close the device number entry field. The entered number of devices displays at the cursor position in the list.

Enter the number of common M devices

- (1) Use the cursor keys to move the position to set the number of common devices.
- (2) Press the [INPUT] key to display the common device number entry field at the bottom of the list and move the focus.



- (3) Enter the number of common devices and press the [INPUT] key. Press the INPUT key to close the common device number entry field. The entered number of common devices displays at the cursor position in the list.

6.18.6.7 Configuring Device Settings

Normal operation

- (1) Refer to "Entering the Number of Devices" and specify the number of devices.
- (2) Refer to "Entering the Number of Devices" and specify the number of common M devices.
- (3) Press the [SET] menu key.
- (4) The following message screen displays if the device settings complete without error. Closing the message screen closes the device settings screen and returns to the multiple project parameters screen.

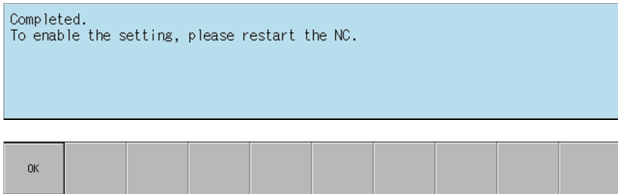

Abnormal operation

This information describes the details of error messages displayed on the device settings screen and the corrective action thereof.

Error message	Error details	Remedy
Please set the number of devices by delimiting 16 points.	This is displayed when the number of devices is not delimited by 16.	Enter a device number that is an interval of 16.
Set the total number of devices per project to 29,000 words or less.	This is displayed when the total number of devices per project is over 29,000 words.	Enter the device numbers so that the total number of devices per project is less than 29,000 words.
The maximum number of devices that can be set is 60,000.	This is displayed when there are areas where the number of devices entered is more than 60,000.	Enter a number of devices that is less than 60,000.

6.18.6.8 Closing the Device Settings Screen

Use any of the following methods to close the device settings screen.

Methods to close the screen
Press the [SET] menu key to complete the device settings without errors.
Press the [CLOSE] menu key.
Press the left arrow key.
Press the [ESC] key on the software keyboard.

6.19 PLC Diagnosis Menus

6.19.1 PLC Diagnosis Screen

6.19.1.1 Outline

This displays the details of error that occur when executing sequence programs. Refer to "5.13.2 Checking PLC Alarms on CNC Controller" for error details.

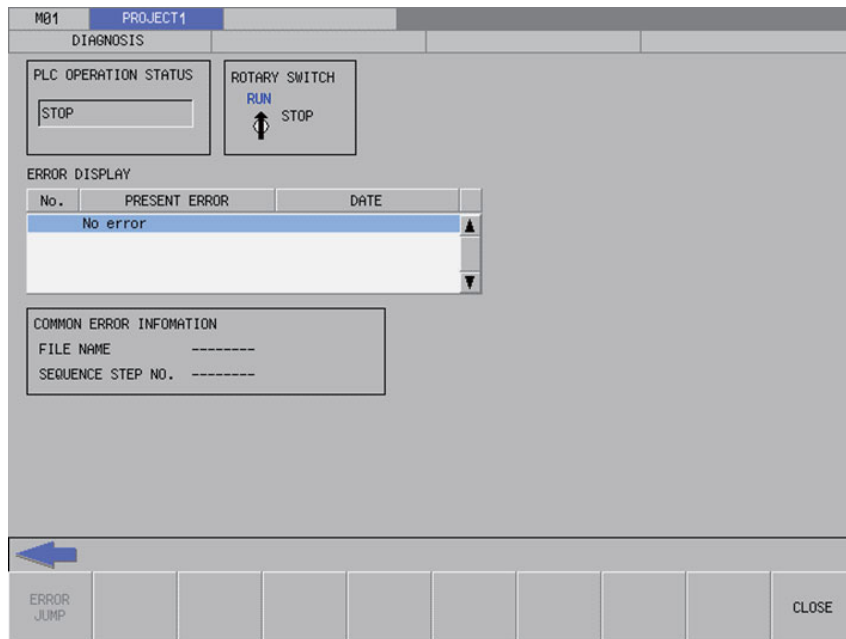

6.19.1.2 Screen Display Items

The following table describes the screen display items for the PLC diagnosis screen.

Item name	Display state
Connected NC name	This displays the name of the connected NC.
Current project No.	This displays the current project number.
Current project label	This displays the project label.
Alarm message	Alarm messages are displayed when alarms occur.
Left arrow key	This is displayed when enabled.
Software keyboard	This is displayed only when parameters are enabled.
Rotary switch	This displays the status of the "CS2" rotary switch on the NC device body.
PLC operation status	This displays the PLC operation status of the currently used project.
Error display	This displays information on errors that occurred with the currently used project.
Common error information	This displays detailed information on errors that occurred with the project selected in the error information.

6.19.1.3 Enabled/Disabled State of Menu Keys

The following table describes the conditions upon which menu keys displayed on the program settings screen are enabled/disabled.

The menu keys which are not described in the following table are always enabled.

Menu name	Condition upon which it is enabled/disabled
Error Jump	This is enabled when an error occurs with a sequence program and the sequence step No. that generated the error is known. Hidden when operation mode is GX Works2.

6.19.1.4 Status during Screen Displays

The following table describes the status when displaying the PLC diagnosis screen.

Item name	Operation
Rotary switch	This displays the current status of the rotary switch.
PLC operation status	This displays the PLC operation status of the currently used project.
Error display	This displays information on errors that occurred with the currently used project.
Common error information	This displays detailed information on errors that occurred with the project selected in the error information.

6.19.1.5 Operation of Key Presses

The following table describes the operation of each menu key and the keys on the NC keyboard when pressed.

Item name	Operation
Left arrow key	Refer to "6.19.1.9 Closing the PLC Diagnosis Screen".
Error jump	Refer to "6.19.1.8 Error Jump".
Close	Refer to "6.19.1.9 Closing the PLC Diagnosis Screen".

6.19.1.6 Rotary Switch Status

This displays the status of the "CS2" rotary switch on the NC device body. The display changes depending on the status of the "CS2" rotary switch as illustrated in the following diagram.

- When 0 (normal)



- When 1 (PLC is not running)



6.19.1.7 Error Display

This displays the project number, error number, type of error, date and time the error occurred (hour, minute, seconds), file name, sequence step number, and the parameter number.

This displays "-----" for errors in which the file name, sequence step number, and parameter number are unknown.

The date is displayed using 4 digits according to the Western calendar. (2000-2099)

6.19.1.8 Error Jump

This jumps to the step in the ladder program shown in the common error information regarding the current error. If the project in which the error occurred is different from the current project, this changes the connected project and then opens the ladder screen.

If the error jump cannot be performed, perform the corrective action steps according to the "PLC Alarm List."

6.19.1.9 Closing the PLC Diagnosis Screen

Use any of the following methods to close the PLC diagnosis screen.

Methods to close the screen
Press the [CLOSE] menu key.
Press the left arrow key.
Press the [ESC] key on the software keyboard.

6.20 Software Keyboard

6.20.1 Outline

A software keyboard is placed on the screen of touch panel display devices to enable operation by the user.

A 2-row keyboard is displayed for normal use. The 2-row keyboard displays quick keys intended for entering step numbers and devices.

A 4-row keyboard displays when it is necessary to enter commands and text strings. Menu keys are not displayed when the 4-row keyboard is displayed.

[2-row keyboard display]

←										MONITOR		SET UP		EDIT		DIAGN		MAINTN		→	
SHIFT	H	K	L	M	N	P	R	S	8	DEL	←	↑	→	PgUp							
FULL KEY	T	V	W	X	Y	Z	.	:EOB	F	INPUT	←	↓	→	PgDn							
EDIT	FIND	FIND STEP NO.	SPLIT SCREEN	DEVICE TEST	CHANGE MONITOR DEC/HEX		MOVEMENT ON SPLIT SCREEN		PROGRAM CHANGE												

[4-row keyboard display]

←										MONITOR		SET UP		EDIT		DIAGN		MAINTN		→			
SHIFT	1	2	3	4	5	6	7	8	9	0	DEL	INS	PgUp										
BACK	=	Q	+	W	-	E	*	R	/	T	\	Y	<	U	>	I	.	O	Ⓟ	P	C.B	A/a	PgDn
ESC	BCD	Z	BIN	X	MOV	C	INC	V	DEC	B	CALL	N	RET	M	SP	INPUT	←	↓	→				









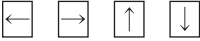

6.20.2 Description of Keys

6.20.2.1 Alphanumeric Keys, Symbol Keys

Key	Operation
	The entry of each character key is displayed in the corresponding input parameter. Enabling the Caps mode allows switching between uppercase and lowercase English letters (same as a normal keyboard).
	Pressing the [Shift] key plus some character key issues the corresponding control.

6.20.3 Special Keys

Key	Operation
	Pressing the [Enter] key issues the command to the corresponding input parameter.
	Pressing the [ESC] key issues the command to the corresponding input parameter.
	Turns the keyboard Caps Lock on. Pressing this again turns Caps Lock off. Caps Lock is disabled while pressed. (lowercase input) Caps Lock is enables when released. (uppercase input)
	Sets the keyboard to the Shift mode so that the key to the upper-left of keys can be input. Pressing again or entering one character cancels the Shift mode. Pressing [Ctrl] does not cancel the Shift mode. Pressing Ctrl+SHIFT+some other key issues the key code corresponding+some other key issues the key code corresponding to the combination of Ctrl and the key. Shift mode is enabled by being pressed. Shift mode is disabled by being released.
	Pressing the [PageUp] key issues the command to the corresponding input parameter.
	Pressing the [PageDown] key issues the command to the corresponding input parameter.

Key	Operation
	This changes the input mode from overwrite to insert and from insert to overwrite. Pressing the [Insert] key issues the command to the corresponding input parameter.
	This deletes one character before the cursor. Pressing the [Delete] key issues the command to the corresponding input parameter.
	This deletes all data input into the corresponding parameter. Pressing the [Shift + Home] keys issues the command to the corresponding input parameter.
	These move the cursor. Press the cursor keys issues the command to the corresponding input parameter.
	Pressing the TAB key issues the command to the corresponding input parameter.
	Pressing the Shift + TAB keys issues the command to the corresponding input parameter.
	This switches from the PLC on-board to the operation screen in the Mitsubishi Electric standard screen.
	This switches from the PLC on-board to the set up screen in the Mitsubishi Electric standard screen.
	This switches from the PLC on-board to the edit screen in the Mitsubishi Electric standard screen.
	This switches from the PLC on-board to the diagnosis screen in the Mitsubishi Electric standard screen.
	This switches from the PLC on-board to the maintenance screen in the Mitsubishi Electric standard screen.

- The operation of each key must be supported by the processing performed for the corresponding input parameter. If not supported, there is no resulting operation from pressing these buttons.
- Only the cursor keys, the tab key, the reverse tab key, the "PgUp" key, and the "PgDn" key can issue repeatedly by pressing and holding the keys.

6.21 Canceling File Passwords

6.21.1 Outline

There are two methods to cancel file passwords: canceling with menu keys (password cancellation menu) and canceling when accessing files.

Refer to "6.13.11 Cancel Password Popup Screen" for information on canceling passwords with menu keys.

The screen for canceling passwords when accessing files displays when the file access attribute matches the password attribute due to key operation.

Refer to "6.6.3 Passwords for PLC Data" for details.

Operation		Registered attribute		Displayed password cancellation screen
		Writes not allowed	Read and writes not allowed	
NC File Operation Menu				
	Open (Opened screen display) -> Open	-	○	List cancellation
	File operation (file operation screen display)			
	Delete data (delete data popup display) -> Delete	○	○	Single deletion
	Rename data (rename data popup display) -> Change	○	○	Single deletion
	Cancel password	Not applicable		List cancellation
	PLC Version up	○	○	List cancellation
External File Operation Menu				
	External -> NC (External -> NC screen display) -> Execute	○	○	List cancellation
	NC -> External (NC -> External screen display) -> Execute	-	○	List cancellation
	Verify external file (verify external file screen) -> Execute	-	○	Single deletion
	Cancel password	Not applicable		List cancellation
Ladder edit menu				
	Ladder edit (ladder screen) -> Edit -> Convert ladder	○	○	Single deletion
Starting PLC On-board with single project settings		Not applicable		Not displayed
Changing projects with multiple project settings		Not applicable		Not displayed

6.21.2 Canceling Individual File Passwords

6.21.2.1 Screen Display Items

The following table describes the screen display items for the cancel individual file password screen.

Item name	Display state
Password	Enter the password. Entered passwords are displayed using asterisks. Input range: 4 single-byte alphanumeric characters

6.21.2.2 Enabled/Disabled State of Menu Keys

The menu keys displayed on the cancel individual file passwords screen are always enabled.

6.21.2.3 Status during Screen Displays

The following table describes the status when displaying the cancel individual file passwords screen.

Item name	Operation
Password	This is the default focus position when the screen is displayed. This is left blank.

6.21.2.4 Operation of Key Presses

The following table describes the operation of each menu key and the keys on the NC keyboard when pressed.

Item name	Operation
Left arrow key	Refer to "6.21.2.6 Closing the Cancel Individual File Passwords Screen".
Execute	Refer to "6.21.2.5 Canceling Passwords".
Close	Refer to "6.21.2.6 Closing the Cancel Individual File Passwords Screen".

6.21.2.5 Canceling Passwords

Normal operation

- (1) Enter the password.
- (2) Press the [EXECUTE] menu key.

Pressing the menu key closes the password cancellation screen and continues with the original process.

Abnormal operation

This information describes the details of error messages displayed when entering passwords and pressing the [EXECUTE] menu key and the corrective action thereof.

Error message	Error details	Remedy
The entered password is not correct. Enter correct password.	This is displayed when the [EXECUTE] menu key is pressed after entering an incorrect password.	The file for which an incorrect password was entered is displayed again. Enter the correct password and then press the [EXECUTE] menu key again.

6.21.2.6 Closing the Cancel Individual File Passwords Screen

Use any of the following methods to close the cancel individual file passwords screen.

Methods to close the screen
Press the [CLOSE] menu key.
Press the left arrow key.
Press the [ESC] key on the software keyboard.

6.21.3 Canceling Batch File Passwords

Refer to "6.13.11 Cancel Password Popup Screen" for more information on canceling batch file passwords.

6.22 Restrictions

6.22.1 Enhanced PLC Security Mode

When enhanced PLC security mode is enabled on a CNC, some functions of PLC on-board development are restricted. For details on the enhanced PLC security mode, refer to "9.1 Enhanced PLC Security Mode".

Appendix 1: Comparison of PLC Related Sections in Each Model

7.1 Device Comparison

[List of device differences (Machining center system)]

		M7 Series Device range		M8 Series Device range		M8V Series Device range	
X		X0 to X1FFF	8192 point	X0 to X1FFF	8192 point	X0 to X1FFF	8192 point
Y		Y0 to Y1FFF	8192 point	Y0 to Y1FFF	8192 point	Y0 to Y1FFF	8192 point
M		M0 to M10239	10240 point	M0 to M61439	61440 point	M0 to M61439	61440 point
L		L0 to L511	512 point	L0 to L1023	1024 point	L0 to L1023	1024 point
F		F0 to F1023	1024 point	F0 to F2047	2048 point	F0 to F2047	2048 point
SB		SB0 to SB1FFF	512 point	SB0 to SB3FFF	1024 point	SB0 to SB3FFF	1024 point
B		B0 to B1FFF	8192 point	B0 to BDFFF	57344 point	B0 to BDFFF	57344 point
SM		SM0 to SM1023	1024 point	SM0 to SM2047	2048 point	SM0 to SM2047	2048 point
V		V0 to V255	256 point	V0 to V511	512 point	V0 to V511	512 point
SW		SW0 to SW1FF	512 point	SW0 to SW3FF	1024 point	SW0 to SW3FF	1024 point
SD		SD0 to SD1023	1024 point	SD0 to SD2047	2048 point	SD0 to SD2047	2048 point
T		T0 to T703	704 point	T0 to T2047	2048 point	T0 to T2047	2048 point
ST		ST0 to ST63	64 point	ST0 to ST127	128 point	ST0 to ST127	128 point
C		C0 to C255	256 point	C0 to C511	512 point	C0 to C511	512 point
D		D0 to D2047	2048 point	D0 to D4095	4096 point	D0 to D4095	4096 point
R		R0 to R32767	32768 point	R0 to R32767	32768 point	R0 to R32767	32768 point
ZR		Unsupported		ZR0 to ZR13311	13312 point	ZR0 to ZR32767	32768 point
W		W0 to W1FFF	8192 point	W0 to W2FFF	12288 point	W0 to W2FFF	12288 point
Z		Z0 to Z13	14 point	Z0 to Z13	14 point	Z0 to Z13/Z0 to Z9	14 points/10 points(*1)
N		N0 to N7	8 point	N0 to N14	15 point	N0 to N14	15 point
P		P0 to P2047 P4000 to P4005	2048 point	P0 to P4095	4096 point	P0 to P4095	4096 point
K	16-bit command	K-32768 to K32767		K-32768 to K32767		K-32768 to K32767	
	32-bit command	K-2147483648 to K2147483647		K-2147483648 to K2147483647		K-2147483648 to K2147483647	
H	16-bit command	H0 to HFFFF		H0 to HFFFF		H0 to HFFFF	
	32-bit command	H0 to HFFFFFFF		H0 to HFFFFFFF		H0 to HFFFFFFF	

(*1) The number of device points varies depending on the bit selection parameter "#6471/bit1" (array valid) setting.

Note

(1) Assignment of input signals for the control unit follows that of M7 Series.

Appendix 2: List of PLC Alarms

PLC diagnosis for each CNC PLC alarm, as well as the error details, causes and remedies are provided below.

NC alarm display (M8V Series)				NC operating status	PLC diagnosis			
Message	Level	Sub-status			Error code SD0	Diagnosis display character string	File name	Step No.
		1	2					
U01 No user PLC	ALM (Red)	-	-	Emergency stop (S/W EMG)	-	-	-	-
U10 Illegal PLC (User PLC is illegal) • "xx" in the lower 16 bits of the sub-status 1 indicates the program No. (0x01 to 0x78 (in the hexadecimal form)) • The sub-alarm No. "yy" of sub-status 1 indicates the project No. ("yy" is not displayed when the maximum number of projects is 1)	ALM (Red)	0x04xx	Step No.	Emergency stop (S/W EMG)	4	S/W INT. ERR	○	○
	ALM (Red)	0x100*	-	Emergency stop (S/W EMG)	10	H/W ERR		
	ALM (Red)	0x110*	-	Emergency stop (S/W EMG)	11	PLC SYS INIT ERR		
	ALM (Red)	0x120*	-	Emergency stop (S/W EMG)	12	LAD NUM OVER		
	ALM (Red)	0x130*	-	Emergency stop (S/W EMG)	13	DATA NUM OVER		
	ALM (Red)	0x20xx.yy	Step No.	Emergency stop (S/W EMG)	20	JUMP LABEL ERR	○	○
	ALM (Red)	0x21xx.yy	Step No.	Emergency stop (S/W EMG)	21	DUP. LABEL(P)	○	○
	ALM (Red)	0x22xx.yy	-	Emergency stop (S/W EMG)	22	LOCAL LABEL OVER	○	

Error contents and cause	Remedy
<p>No sequence program is included in the built-in ROM or temporary memory area.</p> <p>(1) Sequence program is not stored in the built-in ROM. (2) Sequence program is not written from the GX Developer/GX Works2 or internal PLC edit function. (3) Sequence program cannot be read due to broken built-in ROM. (4) No large capacity PLC additional specifications.</p>	<p>(1) Write the sequence program from the GX Developer/GX Works2 or internal PLC edit function, and then execute the built-in ROM writing.</p> <p>(2) Check the presence of additional specification "Large PLC capacity" and reconsider the storable size.</p> <p>(3) If (1) or (2) does not solve the problem, there is a possibility that built-in ROM is broken.</p>
<p>Software instruction interruption illegal An error was found in data for the sequence program in execution.</p> <p>(1) Sequence program stored in the built-in ROM is broken. (2) Sequence program under development (before writing into F-ROM) is broken.</p>	<p>Contact Mitsubishi Electric.</p>
<p>A H/W error was detected during the PLC execution.</p>	<p>Contact Mitsubishi Electric.</p>
<p>The PLC system execution preparation failed.</p>	<p>Contact Mitsubishi Electric.</p>
<p>Ladder count is over limit (at PLC system startup) The total number of "ladder files" stored in the built-in ROM exceeded the maximum.</p>	<p>Write "sequence program", "comment file", "PLC message file", and "symbolic information file" again.</p>
<p>Data count is over limit (at PLC system startup) The total number of "comment files", "PLC message files", and "symbolic information files" stored in the built-in ROM exceeded the maximum.</p>	<p>Remedy the error in either of the following methods.</p> <p>(1) Select [Format PLC memory] with GX Developer/GX Works2 and format the memory after setting [Target memory] to [Memory card(RAM)]. After that, write "comment file", "PLC message file", and "symbolic information file" again.</p> <p>(2) Create a ladder with [Add New Data] using the built-in PLC editing function and execute "Format". After that, write "sequence program", "comment file", "PLC message file", and "symbolic information file" again.</p>
<p>Label branching error (Before executing PLC) Occurs only when the bit selection parameter (#6452 bit6) "branch destination label check valid" is set to "1".</p> <p>(1) The CJ and CALL instructions were placed to a nonexistent label. (2) The CJ instruction was placed to the global label. (Branching is possible only with the CALL instruction.)</p>	<p>Check the branch destination of the CJ and CALL instructions existing in the steps occurred.</p>
<p>Label duplication error (Before executing PLC)</p> <p>(1) When using the multi-programming method</p> <ul style="list-style-type: none"> • Labels of common pointer are duplicated • Labels of local pointer are duplicated within the same file <p>(2) When using the independent program method, labels are duplicated.</p>	<p>Correct the duplication of the labels existing in the steps occurred.</p>
<p>Local label over (Before executing PLC)</p> <ul style="list-style-type: none"> • Local label" is as "labels of local pointer". <p>The boundary value set with the PC parameter (common pointer boundary value) has been exceeded by the total number of labels of local pointer.</p>	<p>(1) Reduce the number of local labels used.</p> <ul style="list-style-type: none"> • Use as sequentially as possible from P0. <p>(2) Reset the PC parameter (common pointer boundary value).</p>

NC alarm display (M8V Series)				NC operating status	PLC diagnosis			
Message	Level	Sub-status			Error code SD0	Diagnosis display character string	File name	Step No.
		1	2					
U10 Illegal PLC (User PLC is illegal) • "xx" in the lower 16 bits of the sub-status 1 indicates the program No. (0x01 to 0x78 (in the hexadecimal form)) • The sub-alarm No. "yy" of sub-status 1 indicates the project No. ("yy" is not displayed when the maximum number of projects is 1)	ALM (Red)	0x230*.yy	-	Emergency stop (S/W EMG)	23	LABEL PARA. ERR		
	ALM (Red)	0x24xx.yy	Step No.	Emergency stop (S/W EMG)	24	RSV. LABEL ERR	○	○
	ALM (Red)	0x25xx.yy	-	Emergency stop (S/W EMG)	25	PRG. PARA. ERR	○	
	ALM (Red)	0x26xx.yy	-	Emergency stop (S/W EMG)	26	MISSING RET INS.	○	
	ALM (Red)	0x27xx.yy	Step No.	Emergency stop (S/W EMG)	27	LAD. CODE ERR	△	△
	ALM (Red)	0x280*	-	Emergency stop (S/W EMG)	28	MISSING LAD(M)		
	ALM (Red)	0x29xx.yy	-	Emergency stop (S/W EMG)	29	EXE. AREA OVER	○	
	ALM (Red)	0x30xx.yy	Step No.	Emergency stop (S/W EMG)	30	FOR INS. OVER	○	○

Error contents and cause	Remedy
Global label boundary value error (Before executing PLC) • "Global label" is as "labels of common pointer". The content of PC parameter (common pointer boundary value) is not normal. (1) When using the multi-programming method, a value greater than the maximum value is set. (2) When using the independent program method, the label boundary value of common pointer is set.	(1) When using the multi-programming method, correct the common pointer boundary value to an appropriate value. (2) When using the independent program method, delete the common pointer boundary value.
Reserved label error (Before executing PLC) (1) When using the multi-programming method, disabled reserved label exists. (2) When using the independent program method, reserved labels are duplicated.	(1) When using the multi-programming method, delete the reserved label. (2) When using the independent program method: • Delete the PC parameter program settings. • Correct the duplication of reserved labels.
Program setting error (Before executing PLC) (1) When using the multi-programming method, PC parameter setting is not correct. • PC parameter (program setting) is not set. • Unstored program name is set. • The contents of the program name is abnormal. • More than the maximum number of programs that can be set (120 programs) are set (2) When using the independent program method, multiple programs are stored. (3) When the multi-project is valid, the sum of all projects exceeds the number of the programs which can be set (120 programs).	(1) When using the multi-programming method, check the PC parameter program settings. • Check the program settings. • Check the program name stored in the NC. • Review the program name and rename it if necessary. <Example> The program name and the M device number in the PLC program are overlapped. • Set the number to 120 or less. (2) When using the independent program method: • Store only one program file. (3) When the multi-project is valid, set the number of programs that can be set to be less than 120 programs as the sum of all projects.
RET instruction error (1) RET instruction was not executed at the branch destination of the CALL instruction. (2) RET instruction was executed without execution of CALL instruction.	Check the following matters for the entire sequence program to be executed. (1) Check if RET instruction is programmed at the end of sub-routine (2) Check if diverged to the other operation in the middle of sub-routine and RET instruction is not executed. (3) Check if jumped to the END reservation label (P4005) in the middle of sub-routine. (4) Check if there is delimiter (FEND instruction) between adjacent program and sub-routine program.
Ladder code error (Before executing PLC) An error was found in data for the sequence program to be executed. (1) Disabled PLC instruction is used. (2) Devices/labels are used for indexes in array labels. (3) Sequence program stored in the built-in ROM is broken. (4) Sequence program under development (before writing into the built-in ROM) is broken.	(1) Check the sequence programs and delete disabled PLC commands. (2) When devices/labels are used for indexes in array labels, set #4671 bit1 to 1. (3)(4) Transferring, storing and ROM writing of the sequence program must be re-executed with the GX Developer or PLC on-board edit function.
No main processing ladders (Before executing PLC) Main processing program to be executed cannot be> (1) When using the multi-programming method, check the PC parameter program settings. (2) When using the independent program method, add the reservation label (P4002) for the medium speed ladder.	(1) When using the multi-programming method, check the PC parameter program settings. (2) When using the independent program method, add the reservation label (P4002) for the medium speed ladder.
Execution area over (Before executing PLC) The total number of steps for the ladder to be executed has exceeded the size of PLC processor execution area.	Check the PC parameter (program setting) and set so that the total number of steps for the ladder to be executed does not exceed the PLC processor execution area.
FOR instruction nesting over 17th level of nesting for FOR instruction was executed.	Check the number of FOR instruction's nesting depth in the steps to which the error occurred, and limit the number to 16 or less.

NC alarm display (M8V Series)				NC operating status	PLC diagnosis			
Message	Level	Sub-status			Error code SD0	Diagnosis display character string	File name	Step No.
		1	2					
U10 Illegal PLC (User PLC is illegal) • "xx" in the lower 16 bits of the sub-status 1 indicates the program No. (0x01 to 0x78 (in the hexadecimal form)) • The sub-alarm No. "yy" of sub-status 1 indicates the project No. ("yy" is not displayed when the maximum number of projects is 1)	ALM (Red)	0x31xx.yy	Step No.	Emergency stop (S/W EMG)	31	NEXT INS. ERR	△	△
	ALM (Red)	0x32xx.yy	Step No.	Emergency stop (S/W EMG)	32	BREAK INS. ERR	○	○
	ALM (Red)	0x33xx.yy	-	Emergency stop (S/W EMG)	33	STR LAD. ERR	○	
	WNG (Yellow)	0x34xx.yy	Step number	PLC RUN	34	DATA CMD RNG ILL	○	○
	WNG (Yellow)	0x35xx.yy	Step number	PLC RUN	35	REAL NUM ILL	○	○
	WNG (Yellow)	0x36xx.yy	Step number	PLC RUN	36	REAL NUM OVR	○	○
	ALM (Red)	0x400*	-	Emergency stop (S/W EMG)	40	PLC SYSTEM DOWN		
	ALM (Red)	0x500*	-	Emergency stop (S/W EMG)	50	MLT PRJ NUM ILL		
	ALM (Red)	0x510*	-	Emergency stop (S/W EMG)	51	PRJ RATE PRM ILL		
	ALM (Red)	0x520*	-	Emergency stop (S/W EMG)	52	LAD TMP AREA OVR		

Error contents and cause	Remedy
NEXT instruction error (1) NEXT instruction was executed before FOR instruction. (2) After FOR instruction, END(FEND) was executed before NEXT instruction.	(1) Check and correct the NEXT instruction in the step to which the error occurred. (2) Check and correct the ladder circuit of the program to which the error occurred. (Note that the number of steps at the error position is displayed as "0".) • Check if JMP, CALL, CJ instructions were executed between FOR and NEXT instruction, and NEXT instruction was jumped. • Check if FOR instruction and NEXT instruction are all paired.
BREAK instruction error BREAK was executed outside the range between FOR and NEXT instruction.	Check and correct the BREAK instruction in the step to which the error occurred.
Structured ladder error When sequence programs created using structured project are executed	Check if the target sequence program is not created using structured project
Data command range error Description of specified device exceeds command range set on each instruction	Check and correct the usage of instructions existing in the steps occurred
Real number calculation data error When descriptions of specified device are the following values. • Outside the range of the following [single float] $2 \text{ to the power of } -126 \leq \text{Specified device} < 2 \text{ to the power of } 128$ [double float] $2 \text{ to the power of } -1022 \leq \text{Specified device} < 2 \text{ to the power of } 1024$ • -0, Denormalized number, Non-number, $\pm \infty$	Check and correct the usage of instructions existing in the steps occurred
Real number calculation data error When the real number calculation result exceeds the following range. [single float] Calculation result $< 2 \text{ to the power of } 128$ [Double float] Calculation result $< 2 \text{ to the power of } 1024$	Check and correct the usage of instructions existing in the steps occurred
PLC system error	Contact Mitsubishi Electric.
Maximum project No. illegal (at PLC system startup) Multi-project parameter setting is illegal (due to the following reason). • The value outside the setting range (1 to number of usable project) was detected.	(1) Check the presence of the expansion project additional specification and reconsider the setting range. (2) The multi-project parameter (maximum project No.) setting is illegal. Set the multi-project parameter again. (3) If (1) or (2) does not solve the problem, there is a possibility that the NC system is broken. Contact Mitsubishi Electric.
Project ratio illegal Multi-project parameter setting is illegal (due to the following reason). • It was detected that the total of ratios of all projects was outside the range from 0 to 100.	(1) The multi-project parameter (project ratio) setting is illegal. Set the multi-project parameter again. (2) If (1) does not solve the problem, there is a possibility that the NC system is broken. Contact Mitsubishi Electric.
Temporary memory area over (at the PLC system startup) Multi-project parameter setting is illegal (due to the following reason). • The ratio to which the area after the project ratio setting is smaller than the size of ladder stored in the temporary memory area was detected.	(1) Check the presence of additional specification "Large PLC capacity" and reconsider the storable size. (2) The multi-project parameter (project ratio) setting is illegal. Set the multi-project parameter again. (3) If (1) or (2) does not solve the problem, there is a possibility that the NC system is broken. Contact Mitsubishi Electric.

8 Appendix 2: List of PLC Alarms

NC alarm display (M8V Series)				NC operating status	PLC diagnosis			
Message	Level	Sub-status			Error code SD0	Diagnosis display character string	File name	Step No.
		1	2					
U10 Illegal PLC (User PLC is illegal) • "xx" in the lower 16 bits of the sub-status 1 indicates the program No. (0x01 to 0x78 (in the hexadecimal form)) • The sub-alarm No. "yy" of sub-status 1 indicates the project No. ("yy" is not displayed when the maximum number of projects is 1)	ALM (Red)	0x530*	-	Emergency stop (S/W EMG)	53	LAD ROM AREA OVR		
	ALM (Red)	0x540*	-	Emergency stop (S/W EMG)	54	COM AREA OVR		
	ALM (Red)	0x550*	-	Emergency stop (S/W EMG)	55	MLT EXE-TYPE ILL		
	ALM (Red)	0x560*	-	Emergency stop (S/W EMG)	56	MLT EXE-NO ILL		
	ALM (Red)	0x570*	-	Emergency stop (S/W EMG)	57	COM DEV PARA ILL		
	ALM (Red)	0x580*.yy	-	Emergency stop (S/W EMG)	58	DEV NUM PARA ILL		
	WNG (Yellow)	0x700*.yy	-	PLC RUN	70	RUNWRT ILL. MODE		
	WNG (Yellow)	0x71xx.yy	Step No.	PLC RUN	71	RUNWRT CPOINT(F)	○	○
	WNG (Yellow)	0x720*	-	PLC RUN	72	RUNWRT SIZOVR(F)		

Error contents and cause	Remedy
<p>Project execution order illegal (at the PLC system startup) Multi-project parameter setting is illegal (due to the following reason).</p> <ul style="list-style-type: none"> ♦ The ratio to which the area after the project ratio setting is smaller than the size of ladder stored in the built-in ROM area was detected. 	<p>(1) Check the presence of additional specification "Large PLC capacity" and reconsider the storable size. (2) The multi-project parameter (project ratio) setting is illegal. Set the multi-project parameter again. (3) If (1) or (2) does not solve the problem, there is a possibility that the NC system is broken. Contact Mitsubishi Electric.</p>
<p>Comment area over (at the PLC system startup) Multi-project parameter setting is illegal (due to the following reason).</p> <ul style="list-style-type: none"> ♦ The ratio to which the area after the project ratio setting is smaller than the size of comment and message stored in the built-in ROM area. 	<p>(1) The parameter setting for the number of device points is illegal. Set the parameter of the number of device points again and reboot the system. (2) If (1) does not solve the problem, there is a possibility that the NC system is broken. Contact Mitsubishi Electric.</p>
<p>Parameter setting illegal for number of device points (at PLC system startup) Multi-project parameter setting is illegal (due to the following reason).</p> <ul style="list-style-type: none"> ♦ The value outside the setting range (ON/OFF) was detected. ♦ All execution projects are OFF. 	<p>(1) The multi-project parameter (execution project) setting is illegal. Set the multi-project parameter again. (2) If (1) does not solve the problem, there is a possibility that the NC system is broken. Contact Mitsubishi Electric.</p>
<p>Execution project illegal (at the PLC system startup) Multi-project parameter setting is illegal (due to the following reason).</p> <ul style="list-style-type: none"> ♦ The value outside the setting range (1 to 6) was detected. ♦ The redundant project execution order number was detected. 	<p>(1) The multi-project parameter (project execution order) setting is illegal. Set the multi-project parameter again. (2) If (1) does not solve the problem, there is a possibility that the NC system is broken. Contact Mitsubishi Electric.</p>
<p>Parameter setting illegal for the number of common device points (at PLC system startup) Multi-project parameter setting is illegal (due to the following reason).</p> <ul style="list-style-type: none"> ♦ The value outside the setting range (0 to the minimum number of points in all projects) was detected. ♦ It was detected that the number of points was not a multiple of 16. 	<p>(1) Check the presence of the expansion project additional specification and reconsider the setting range. (2) The multi-project parameter (project ratio) setting is illegal. Set the multi-project parameter again. (3) If (1) or (2) does not solve the problem, there is a possibility that the NC system is broken. Contact Mitsubishi Electric.</p>
<p>Parameter setting illegal for number of device points (at PLC system startup)</p> <p>(1) The parameter setting for the number of device points is illegal (due to the following reasons).</p> <ul style="list-style-type: none"> ♦ The total number of points in one project 29K or more was set. ♦ The illegal value (-1 point or less, or 61441 points or more) for the number of device points was detected. ♦ It was detected that the number of device points was not a multiple of 16. ♦ The number outside the usable number of device points in whole projects was detected. 	<p>(1) The parameter setting for the number of device points is illegal. Set the parameter of the number of device points again and reboot the system. (2) If (1) does not solve the problem, there is a possibility that the NC system is broken. Contact Mitsubishi Electric.</p>
<p>Caution; Ladder program writing during RUN is disabled (In independent program method) With RUN write ON, sequence program is operated in independent program method. Run write is not available with this condition.</p>	<p>The ladder program writing (RUN write) can not be used in independent program method. Change the method into multi-program one.</p>
<p>Caution; Ladder program writing during RUN is disabled (common pointer is used in high-speed processing) With RUN write is ON, high-speed program with common pointer is running. Run write is not available with this condition.</p>	<p>RUN write is not available when high-speed processing with common pointer is running. Change the high-speed processing program to the one without common pointer.</p>
<p>Caution; Ladder program writing during RUN is disabled (high-speed processing size is exceeding) With RUN write ON, the execution size of high-speed processing program has exceeded 4000 steps. Run write is not available with this condition.</p>	<p>RUN write is not available when execution size of high-speed processing program exceeds 4000 steps. Edit the high-speed processing program to reduce the execution size to 4000 steps or less. (When multi-project is valid, edit the program to reduce the execution size to 4000 steps or less in total of all the project.)</p>

NC alarm display (M8V Series)				NC operating status	PLC diagnosis			
Message	Level	Sub-status			Error code SD0	Diagnosis display character string	File name	Step No.
		1	2					
U10 Illegal PLC (User PLC is illegal) <ul style="list-style-type: none"> • "xx" in the lower 16 bits of the sub-status 1 indicates the program No. (0x01 to 0x78 (in the hexadecimal form)) • The sub-alarm No. "yy" of sub-status 1 indicates the project No. ("yy" is not displayed when the maximum number of projects is 1) 	WNG (Yellow)	0x730*.yy	-	PLC RUN	73	RUNWRT LLABEL(F)		
	WNG (Yellow)	0x80xx.yy	Step No.	PLC RUN	80	EXC.INT(BCD)	○	○
	WNG (Yellow)	0x81xx.yy	Step No.	PLC RUN	81	EXC.INT(BIN)	○	○
	ALM (Red)	0x82xx.yy	Step No.	Emergency stop (S/W EMG)	82	EXC.INT(D-BUS)	△	△
	ALM (Red)	0x83xx.yy	Step No.	Emergency stop (S/W EMG)	83	EXC.INT(INST.)	△	△
	ALM (Red)	0x84xx.yy	Step No.	Emergency stop (S/W EMG)	84	EXC.INT(I-FMT)	△	△
	ALM (Red)	0x85xx.yy	Step No.	Emergency stop (S/W EMG)	85	EXC.INT(I-BUS)	△	△
	ALM (Red)	0x86xx.yy	Step No.	Emergency stop (S/W EMG)	86	EXC.INT(CALL)	△	△
	ALM (Red)	0x8Bxx.yy	Step No.	Emergency stop (S/W EMG)	91	EXC.INT(A-BUS)	△	△
U50 Ladder stopped	WNG (Yellow)	-	-	Emergency stop (S/W EMG)	-	-	-	-
U55 Ladder stopped / is not saved	WNG (Yellow)	-	-	Emergency stop (S/W EMG)	-	-	-	-
U60 Ladder is not saved	WNG (Yellow)	-	-	PLC RUN	-	-	-	-

Error contents and cause	Remedy
Caution; Ladder program writing during RUN is disabled (number of labels in high-speed processing is beyond the capacity) • "Local label" is as "labels of local pointer". With RUN write ON, the number of labels of local pointer in high-speed processing program has exceeded 256. Run write is not available with this condition.	RUN write is not available when the number of labels of local pointer in high-speed processing program exceeds 256. Edit the high-speed program to reduce the number of labels of local pointer to less than 256. (When multi-project is valid, edit the program to reduce the number of labels of local pointer to less than 256 per project.)
Software exceptional interruption (BCD instruction error) has occurred. With BCD and DBCD instructions, BIN value outside its input range was attempted to be converted into BCD.	Check the usage of BCD, DBCD instructions existing in the steps occurred.
Software exceptional interruption (BIN instruction error) has occurred. With BIN and DBIN instructions, BCD value outside its input range was attempted to be converted into BIN.	Check the usage of BIN, DBIN instructions existing in the steps occurred.
Software exceptional interruption (Bus error) has occurred. When the specified device exceeds the range of the device	(1) Check and correct the device range that the instruction in the step of which the error occurred accesses. (2) Contact Mitsubishi Electric.
Software exceptional interruption (Instruction bus error) has occurred. (1) When the bit selection parameter (#6452 bit6) "branch destination label check valid" is set to "0", jumped to an undefined label. (2) Sequence program in execution is broken.	(1) Set the bit selection parameter (#6452 bit6) "branch destination label check valid" to "1" and check the branching step to the undefined label. (2) Contact Mitsubishi Electric.
Software exceptional interruption (Instruction format error) has occurred.	Contact Mitsubishi Electric.
Software exceptional interruption (Instruction bus error) has occurred. (1) When the bit selection parameter (#6452 bit6) "branch destination label check valid" is set to "0", jumped to an undefined label. (2) Sequence program in execution is broken.	(1) Set the bit selection parameter (#6452 bit6) "branch destination label check valid" to "1" and check the branching step to the undefined label. (2) Contact Mitsubishi Electric.
Software exceptional interruption (CALL/RET instruction error) has occurred.	Contact Mitsubishi Electric.
Software exceptional interruption (ASYNC BUS error) has occurred.	Contact Mitsubishi Electric.
The ladder is stopped.	Run the PLC.
The ladder is stopped and the edited sequence program is not stored in the built-in ROM. (The contents of temporary memory area and sequence program in the builtin ROM are mismatched.)	Run the PLC. Use GX Developer/GX Works2 or the built-in PLC edit function to perform write to the built-in ROM.
The edited sequence program is not stored in the built-in ROM. (The contents of temporary memory area and sequence program in the built-in ROM are mismatched.)	Use GX Developer/GX Works2 or the built-in PLC edit function to perform write to the built-in ROM.

Appendix 3: PLC Function

9.1 Enhanced PLC Security Mode

This function restricts connections to the built-in PLC from applications such as PLC on-board and GX Developer/GX Works2. This function helps protect the assets in the built-in PLC.

Two modes are available in this function.

[PLC write protect mode, which inhibits only write operations by applications]

This mode prevents accidentally overwriting sequence programs and modifying device values when a sequence program is monitored.

[PLC read/write protect mode, which inhibits write operations and monitoring operations by applications]

This mode protects sequence programs from being overwritten or read out by an unauthorized user.

While this function is used, one of the multi-projects can be set as the "E/U project". (The "E/U mode")

Using this project enables end users to create sequence programs to which a new jig or sensor is to be added. The other sequence programs created by the MTB are protected from changing or deleting, because these projects are prohibited the end users from being connected.

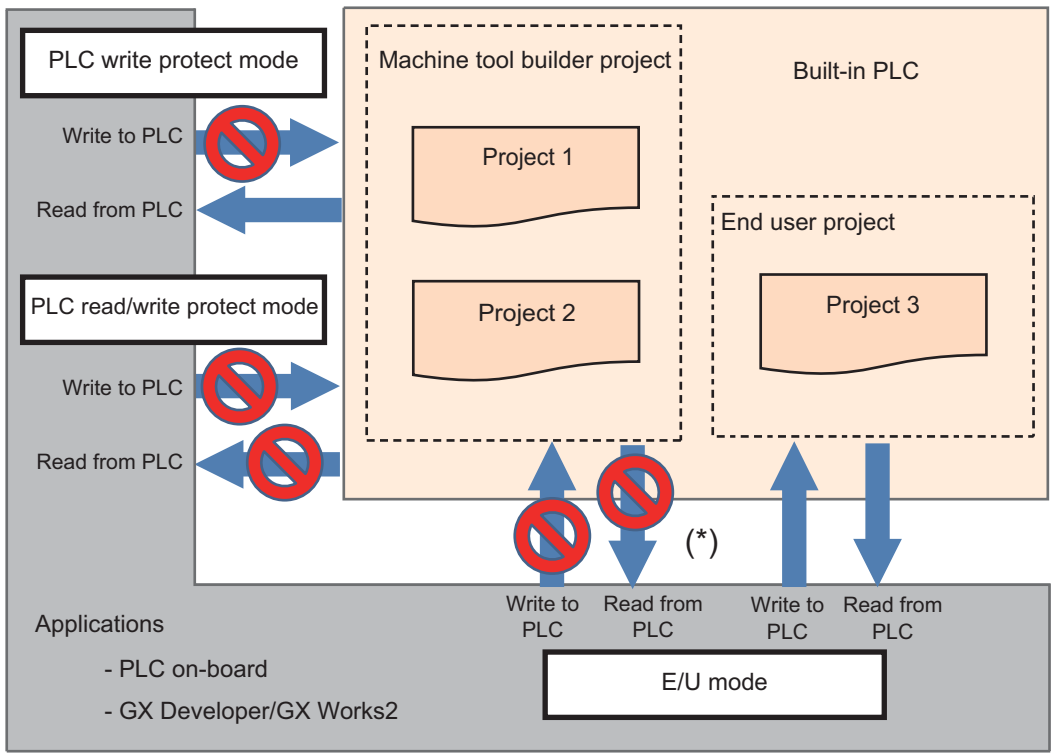

(*) Read/write operations between the application and the machine tool builder project depend on the enhanced PLC security mode settings.

9.1.1 Function Details

9.1.1.1 Definitions of Terms

The following table provides the definitions for the terms used in this section.

Term	Definition
PLC write protect mode	A mode that inhibits write operations to the built-in PLC from PLC on-board and GX Developer/GX Works2.
PLC read/write protect mode	A mode that inhibits read/write operations to the built-in PLC from PLC on-board and GX Developer/GX Works2.
Enhanced PLC Security Mode	A generic term for PLC write protect mode and PLC read/write protect mode.
E/U	This represents an end user.
MTB	This represents a machine tool builder.
PLC E/U customization	Partial PLC customization by the end user
E/U mode	A mode that allows the end user to partially customize PLC
E/U project	A project that can be customized by the end user
E/U program	A sequence program created and stored in the E/U project by the end user
E/U open device	A project-common device that can be output by an E/U program
E/U open interface	Interface that associates between E/U open devices and output of NC-PLC interface and remote I/O
MTB project	A project other than E/U project
MTB program	A sequence program created and stored in an MTB project by MTB
MTB password	Indicates a password set by machine tool builder. It can be changed on the protection setting screen.
Password status	Status of whether the MTB password is disabled or not. The operation level when the password is disabled can be set on the protection setting screen. This section explains on the assumption that all data is accessible when the password is disabled.

9.1.1.2 Enabling Conditions

■ Enhanced PLC Security Mode

This function is enabled by setting the following value to the dedicated parameter.

Enhanced PLC Security Mode		#11761 PLC Security Mode (Enhanced PLC security mode)
Enabled	PLC write protect mode	1
	PLC read/write protect mode	2
Disabled		0

■ E/U mode

This function is enabled when the following conditions are satisfied.

E/U mode	Enhanced PLC Security Mode	#11762 E/U Project No. (End-user project number)
Enabled	Enabled (#11761 is set to "1" or "2".)	1 to 6
	Disabled (#11761 is set to "0".)	-
Disabled	Enabled (#11761 is set to "1" or "2".)	0
	Disabled (#11761 is set to "0".)	-

■ The connection restriction on GX Developer/GX Works2

When the parameter "#11094 GX Restriction" (Inhibiting GX Developer/GX Works2 connection) is set to "1", the connection restriction is enabled. When the connection restriction is enabled, the connections to the built-in PLC from GX Developer/GX Works2 are inhibited.

■ Note

(1) To certainly secure sequence programs and device values which are managed by the MTB, change the default password for MTB to another one. The following items can be changed on the protect setting screen.

- ◆ Operation level
- ◆ MTB password for each operation level
- ◆ Protection level of each data item

For details on the protect setting screen, refer to "Connection and Setup Manual".

9.1.1.3 PLC Write Protect Mode

The PLC write protect mode inhibits PLC on-board and applications, such as GX Developer or GX Works2, from writing sequence programs and modifying PLC device values for all projects in the built-in PLC. Reading sequence programs and monitoring PLC device values are allowed.

This prevents accidentally overwriting the sequence programs in the built-in PLC and modifying device values when sequence programs are read out or device values are monitored by applications.

For details on the application functions available during the PLC write protect mode, refer to "9.1.1.6 Functions Available in Each Mode".

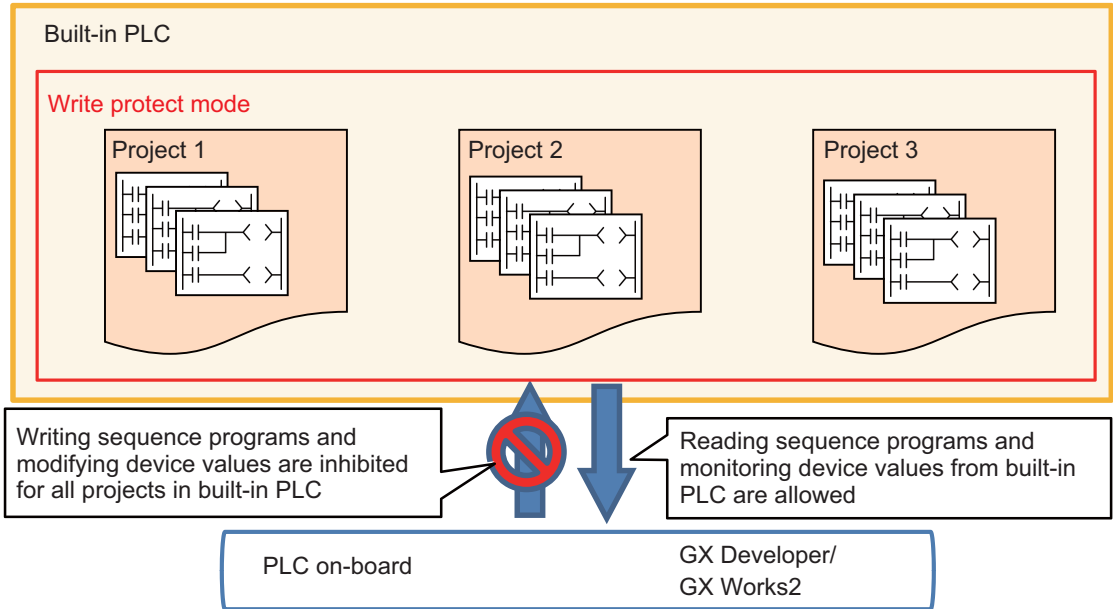

9.1.1.4 PLC Read/Write Protect Mode

The PLC read/write protect mode inhibits PLC on-board or applications, such as GX Developer or GX Works2, from writing sequence programs and modifying PLC device values for all projects in the built-in PLC. In addition, it also prohibits them from monitoring device values.

This prevents an unauthorized user to connect to the built-in PLC from reading/writing the sequence programs in the built-in PLC and monitoring/modifying PLC device values.

For details on the application functions available during the PLC read/write protect mode, refer to "9.1.1.6 Functions Available in Each Mode".

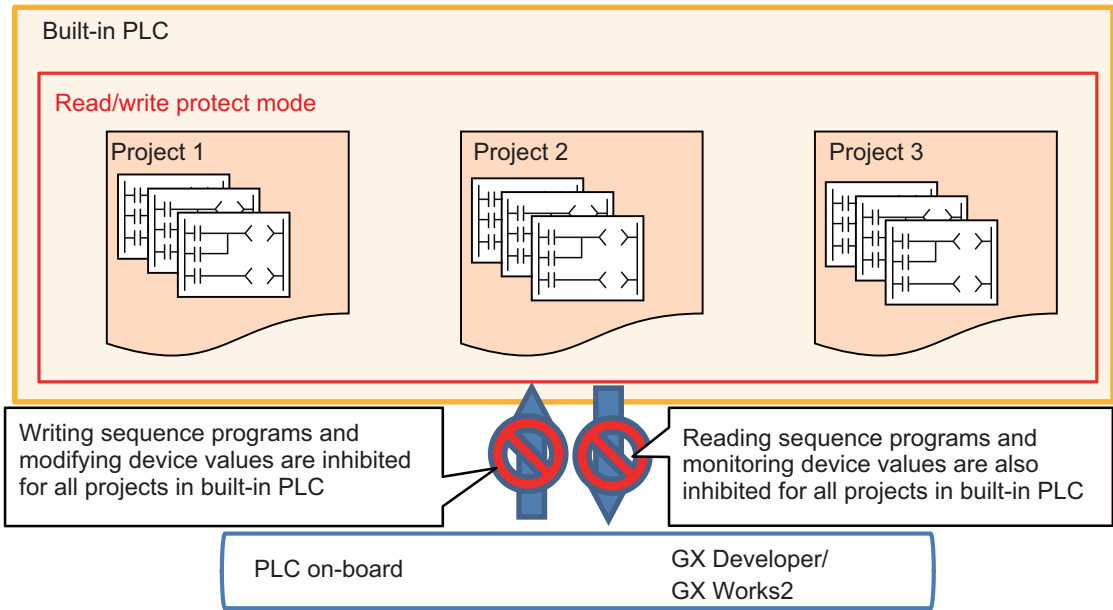

9.1.1.5 E/U mode

In the E/U mode, one of the multi-projects can be set as the "E/U project".

The E/U project can be connected with PLC on-board and GX Developer/GX Works2 irrespective of the enhanced PLC security mode setting and the password status. The connection restrictions between non-E/U project (MTB projects) and the applications depend on the enhanced PLC security mode setting and password status.

This allows end users to create custom sequence programs (E/U programs) in the E/U project and to create necessary control programs when a new jig or sensor is added. The end users, however, are prevented from modifying and deleting sequence programs created by the MTB (MTB programs) because connection restrictions are effective for MTB projects.

Note that different restrictions than the enhanced PLC security mode apply to the connection with the E/U project. For details, refer to "Limitations of E/U Project" described later.

The MTB can set whether the E/U mode is enabled and which project number is used for the E/U project via parameters. End users cannot change these settings.

To enable the E/U mode, the enhanced PLC security mode must be set to the PLC write protect mode or the PLC read/write protect mode. When the enhanced PLC security mode is not set, the E/U mode cannot be enabled.

Note

(1) To enable the E/U mode, change the default password for MTB to another one. The following changes can be made on the protect setting screen.

- Changing operation level
- Changing MTB password for each operation level
- Changing protective level for each data

For details on the protect setting screen, refer to "Connection and Setup Manual".

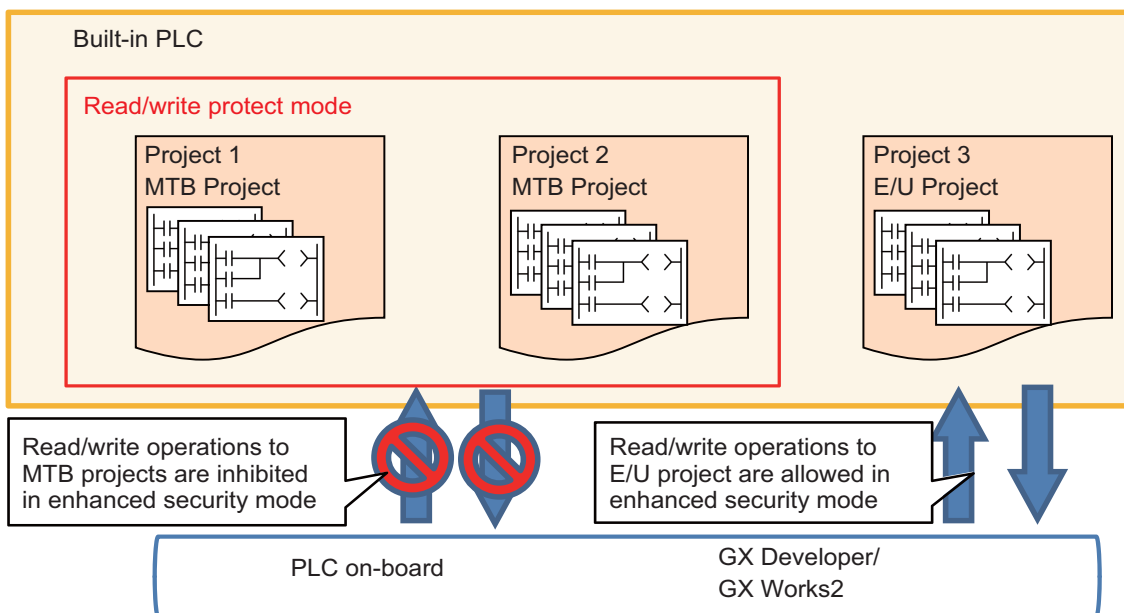

Built-in PLC configuration

In the E/U mode, end users can create and store sequence programs in the E/U project. On the other hand, if sequence programs were allowed to be output from E/U programs to all devices without any restrictions, MTB programs might be affected and it could lead to malfunction of the machine. Consequently, only part of remote I/O (Y device) is available for output from an E/U program. Other output is indirectly performed via project-common devices (M, D devices) by creating interface in MTB programs. The MTB can set the device range that can be customized by the end user (E/U open device) via parameters. No restrictions apply to input to E/U programs.

The following shows the configuration of the built-in PLC when the E/U mode is enabled.

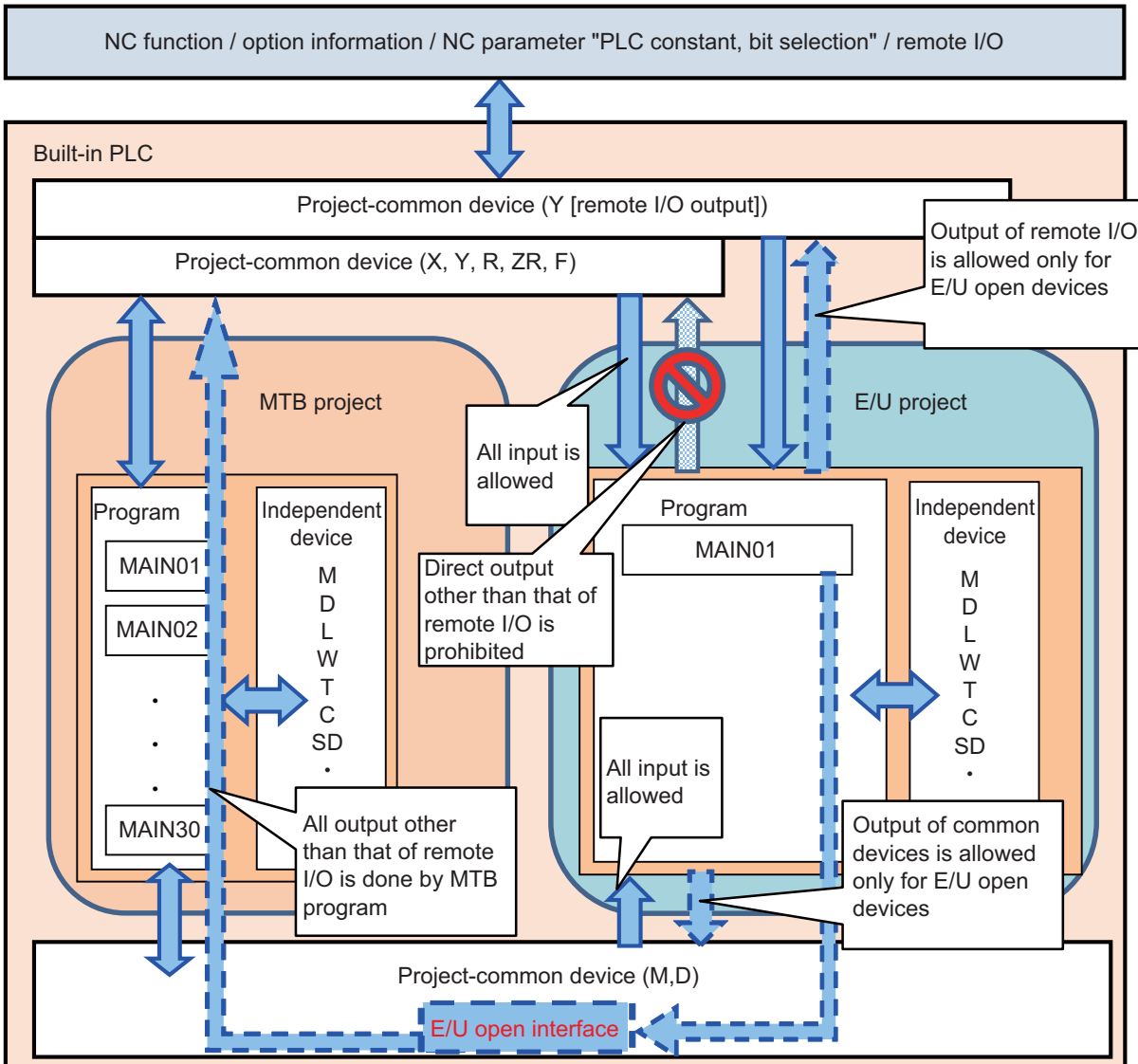

Limitations of E/U project

There are certain limitations on the use of instructions and PLC devices in an E/U program because of the configuration of the built-in PLC in the E/U mode.

Similar limitations on devices apply to the input/output of values between the devices in the E/U project and PLC on-board or GX Developer/GX Works2.

Note that there are also limitations on the application functions that are available for connections with the E/U project in order to prevent end users from modifying the data and the setting of MTB projects.

The following describes these limitations.

■ Limitations on instructions

The following instructions cannot be used in an E/U program.

BMOV(P), FMOV(P), DECO(P), DSFR(P), DSFL(P), S.ROT, S.ATC, G(P).RIRD, G(P).RIWT, Z(P).REMFR, Z(P).REMT0

A sequence program containing these instructions cannot be written to the E/U project. If a sequence program with these instructions has already been written before the E/U project is set, the program can be read from the E/U project to applications, but when you attempt to execute the sequence program, PLC STOP applies and the alarm "U10 Illegal PLC" is issued.

■ Limitations on devices

The limitations on devices for an E/U program are listed in the following table. Note that write operations to the devices through index modification are inhibited, while read operations of device values through index modification are allowed for an E/U program.

The listed limitations also apply to the device input/output between the E/U project and PLC on-board or GX Developer/GX Works2.

Category	Device	Limitations on device	Number of devices	Range of output from end user
Common device	X, Y, F, R, ZR	Can be input/only part of Y can be output	Fixed	Output range of Y can be set via NC parameters
Independent device (variable)	L, B, V, T, ST, C, W	Can be input/output	Can be set via multi-project parameter	Fixed (all devices can be output)
Independent device (fixed)	SM, SD, Z	Can be input/output	Fixed	Fixed (all devices can be output)
Independent device (fixed)	N, P	Can be input/cannot be output	Fixed	Fixed (none of devices can be output)
Common/independent device (independent area)	M, D, SB, SW	Can be input/output	Can be set via multi-project parameter	Fixed (all devices can be output)
Common/independent device (common area)	M, D, SB, SW	Can be input/only part of M and D can be output	Can be set via multi-project parameter	Output range of M and D can be set via NC parameters

Sequence programs not in line with these limitations on devices cannot be written to the E/U project. If a sequence program which does not follow these limitations has already been written before the E/U project is set, the program can be read from the E/U project to applications, but when you attempt to execute the sequence program, PLC STOP applies and the alarm "U10 Illegal PLC" is issued.

Outputting a range including both ranges that can be output and cannot be output, and a range including both ranges of common and independent devices are treated to be not in line with the limitations on devices.

For details of which arguments of the available instructions in the built-in PLC are output, refer to "PLC Programming Manual".

■ Limitations on functions

Formatting from PLC on-board and GX Developer/GX Works2 is not possible while connected to the E/U project. It is also impossible to modify multi-project parameters from PLC on-board.

These limitations prevent end users from deleting MTB programs and modifying MTB project settings.

For details on the functions available for the E/U project, refer to "9.1.1.6 Functions Available in Each Mode".

Limitations of MTB project

The enhanced PLC security mode setting determines what restrictions apply to the input/output of sequence programs and to the input/output of data values to PLC devices for MTB projects.

For details on the functions available for each mode, refer to "9.1.1.6 Functions Available in Each Mode".

PLC messages

The PLC messages for MTB and the PLC messages for end users, which have been created by MTB and end users respectively, are treated as different files and can be managed separately. Both of them can be input/output via the NC standard screen. For details on how to input/output via the standard screen, refer to "5.8 PLC Message Development". The PLC messages for end users can be displayed only when the E/U mode is enabled. They are not displayed when the E/U mode is disabled.

It is also possible to input/output PLC messages from GX Developer/GX Works2.

If there are duplicate indices of PLC messages between input methods, only one message is displayed according to the priorities indicated in the following table.

For both MTB and end users, when they create and write PLC messages from GX Developer/GX Works2, the E/U project must be the last project of multi-projects.

Message type	Input method	File name	Priority	Remarks
PLC message for MTB	Input via the standard screen when the E/U mode is disabled	PLCMSG_XXX.TXT	1	
PLC message for end users	Input via the standard screen when the E/U mode is enabled	PLCUMSG_XXX.TXT	2	Displayed only during E/U mode
GX Developer/GX Works2 PLC message	Input from GX Developer/GX Works2	MXXxxxx.WPG	3	If there are duplicate indices between projects, the message with the smallest project No is displayed.

9 Appendix 3: PLC Function

9.1 Enhanced PLC Security Mode

The PLC messages as shown in the table below, for example, are displayed.

Message type	PLC message for MTB	PLC message for end users	GX Developer/GX Works2 PLC message
Alarm message	A, 1, 0, MTB message 1 A, 4, 0, MTB message 4	A, 1, 0, E/U message 1 A, 2, 0, E/U message 2 A, 4, 0, E/U message 4	A, 1, 0, GX message 1 A, 2, 0, GX message 2 A, 3, 0, G/U message 3
Operator messages	O, 1, 0, MTB message 1 O, 4, 0, MTB message 4	O, 1, 0, E/U message 1 O, 2, 0, E/U message 2 O, 4, 0, E/U message 4	O, 1, 0, E/U message 1 O, 2, 0, GX message 2 A, 3, 0, GX message 3
PLC switch	P, 0, MTB Text1 P, 3, MTB Text4	P, 0, EU Text1 P, 1, EU Text2 P, 3, EU Text4	P, 0, GX Text1 P, 1, GX Text2 P, 2, GX Text3

Display examples of messages are shown below (when the E/U mode is enabled).

PLC switch

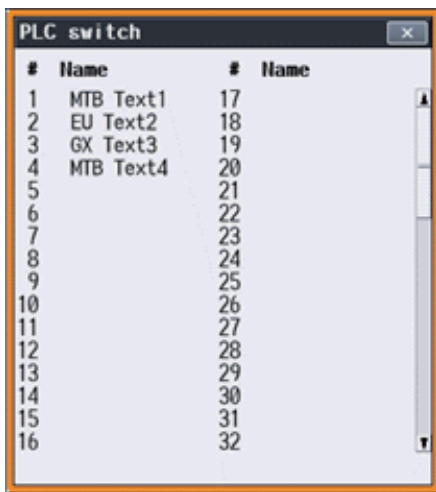

Alarm message and operator messages

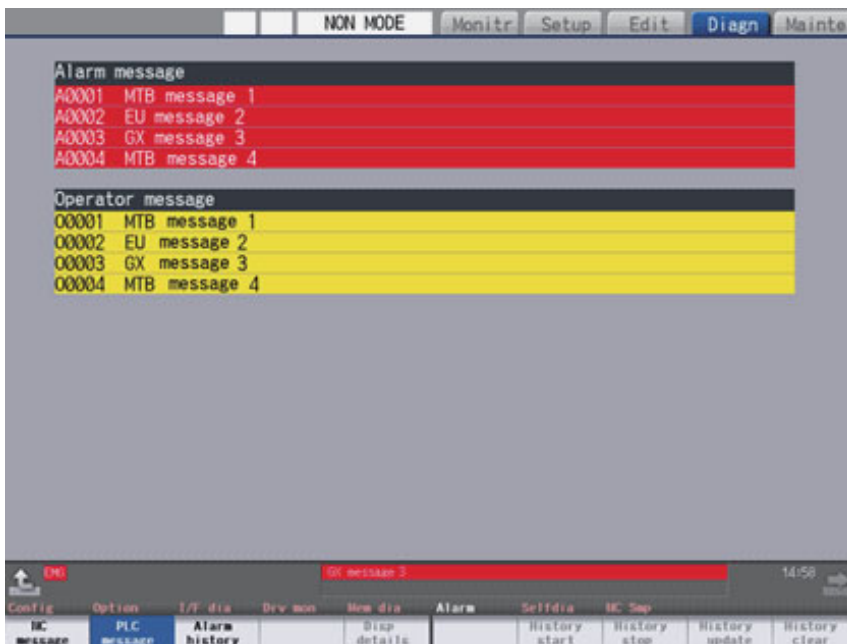

Operation procedure

To use the E/U mode, configure the setting by following the steps below.

- (1) Determine the setting details
- (2) Set the multi-project parameters
- (3) Create MTB programs
- (4) Set NC parameters (E/U customization setting)
- (5) Save an empty E/U project
- (6) Provide information to end users

- (1) Determine the setting details

When the E/U mode setting is desired, MTB must decide the setting details of the following items.

Setting item	Setting
E/U project No.	The project number to be used as the E/U project among multi-projects
Number of devices	The number of available devices for the projects including the E/U project
E/U open device	A range of project-common devices (Y, M, D) that are used by the E/U project
Project execution order	The execution order of the projects including the E/U project
Maximum number of steps	The maximum value for the total number of steps of a sequence program that can be stored in each of the projects including the E/U project
MTB program	A sequence program executed by an MTB project Machine control programs and E/U open interface are included
Enhanced PLC security mode	Security setting for MTB projects (write protect or read/write protect)

9 Appendix 3: PLC Function

9.1 Enhanced PLC Security Mode

(2) Set the multi-project parameters

Modify the multi-project parameters from PLC on-board based on the setting details determined in “Determine the setting details”.

Specify the number of devices, project execution order, and the number of steps for each project.

The number of steps refers to the upper limit of the total number of steps of the sequence programs stored in each project, and is determined by the project ratio.

[Project setting]

Please set the parameters for the operation of the multi-project.

MAX PROJECT No. 01 02 03

LIST

PROJECT No.	01	02	03
PROJ. RATIO(%)	40	40	20
EXECUTE PROJECT	ON	ON	ON
EXE. ORDER	1	2	3

[Device setting]

Please set the number of the device to be used for each project.

	01	02	03	COMMON	TOTAL	REMAIN
M	15360	15360	15360	15360	61440	0
L	256	256	256	0	768	256
B	14336	14336	14336	0	43008	14336
F	0	0	0	2048	2048	0
SB	256	256	256	0	768	256
V	128	128	128	0	384	128
S	0	0	0	0	0	0
T	512	512	512	0	1536	512
ST	32	32	32	0	96	32
C	128	128	128	0	384	128
D	1024	1024	1024	1024	4096	0
W	3072	3072	3072	0	9216	3072
SW	256	256	256	0	768	256
TOTAL	10.0K	10.0K	10.0K			

9 Appendix 3: PLC Function

9.1 Enhanced PLC Security Mode

(3) Create MTB programs

Store MTB programs in projects that is to be set as MTB projects.

The MTB programs must include the programs that will be the interface between the output of remote I/O and the E/U open devices as well as the sequence programs for machine control.

Ensure that the project that is to be set as the E/U project is empty.

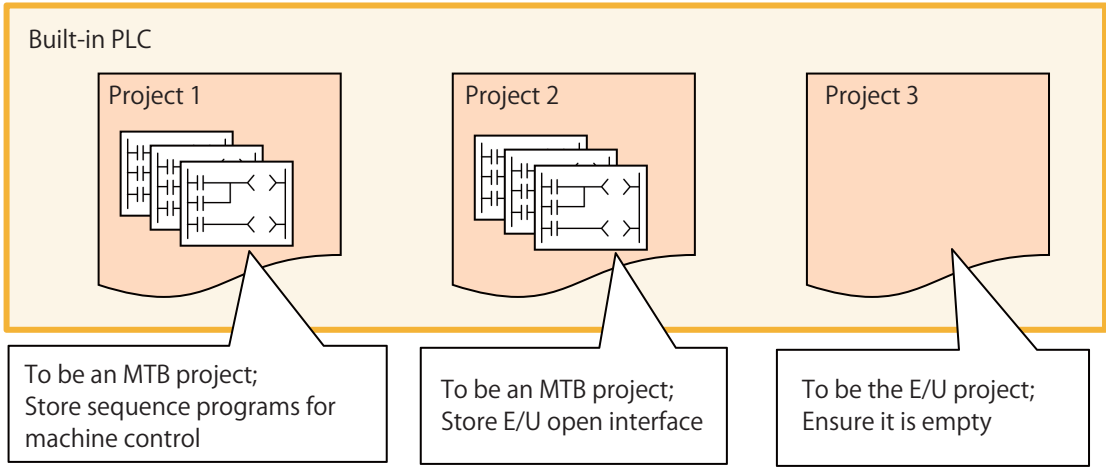

(4) Set NC parameters (E/U customization setting)

Set the NC parameters based on the setting details determined in "Determine the setting details".

Configure the enhanced PLC security mode, E/U project number, and E/U open devices.

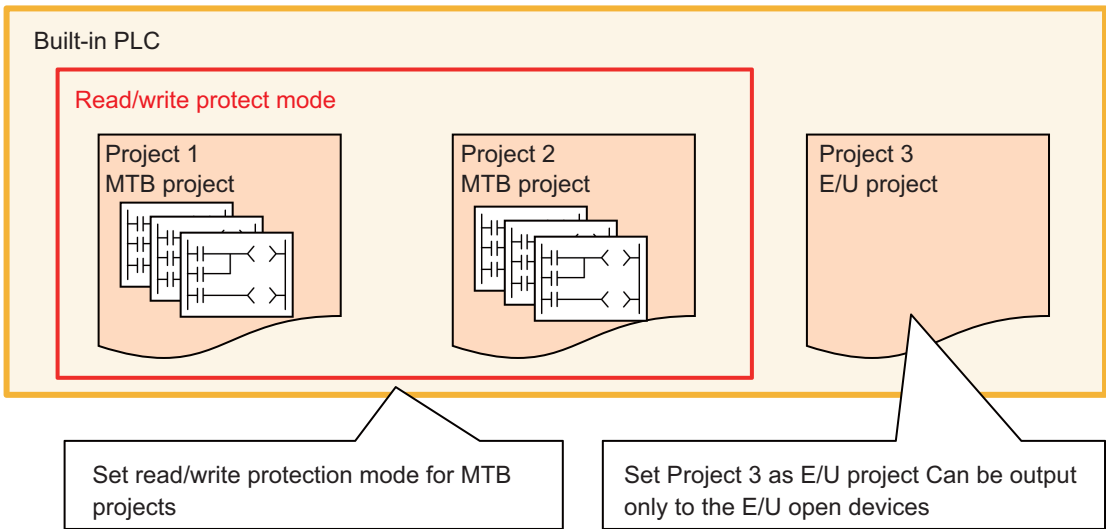

To allow end users to connect to the E/U project from PLC on-board, set the parameter "#6453 R7826-L/bit3" to "1". To prevent end users from connecting to the E/U project from PLC on-board, set the parameter "#6453 R7826-L/bit3" to "0".

(5) Save an empty E/U project

Create the backup of the empty E/U project in case end users forget the file password and the modification and deletion of the E/U program become impossible.

For details on how to create a backup, refer to "5.14 Backing Up Sequence Programs and Other Data".

(6) Provide information to end users

Describe the configured settings in the manual. Refer to "9.1.4 Information to be Shared with End Users" for details.

9.1.1.6 Functions Available in Each Mode

The following table summarizes the functions of PLC on-board and GX Developer/GX Works2 available for each project type, enhanced PLC security mode setting, and MTB password status.

Function matrix by project type, enhanced PLC security mode, MTB password status

○ : Available

×: Unavailable

Function	MTB project						E/U project
	No mode		Write protect mode		Read/write protect mode		-
	Password not disabled	Password disabled	Password not disabled	Password disabled	Password not disabled	Password disabled	-
Start	○ (*1)	○	○ (*1)	○	○ (*1)	○	○
NC FILE OPERATION - File list	○	○	○	○	×	×	○
NC FILE OPERATION - Open	○	○	○	○	×	×	○
NC FILE OPERATION - File operation	×	○	×	×	×	×	○
NC FILE OPERATION - Format	×	○	×	×	×	×	×
NC FILE OPERATION - ROM write	×	○	×	×	×	×	○
NC FILE OPERATION - PLC RUN/STOP	×	○	×	○	×	×	○
NC FILE OPERATION - Password cancellation(*2)	×	○	×	○	×	×	○
NC FILE OPERATION - PLC version up	×	○	×	×	×	×	○
NC FILE OPERATION - External -> NC	×	○	×	×	×	×	○
NC FILE OPERATION - NC -> External	○	○	○	○	×	×	○
NC FILE OPERATION - Delete external file	○	○	○	○	×	×	○
NC FILE OPERATION - Verify external file	○	○	○	○	×	×	○
Monitor ladder	○	○	○	○	×	×	○
Edit ladder	×	○	×	×	×	×	○
Device test	○	○	×	×	×	×	○
ENVIRON. SETTING - Comment display	○	○	○	○	×	×	○
ENVIRON. SETTING - Ladder display	○	○	○	○	×	×	○
ENVIRON. SETTING -Connect NC changing	○	○	○	○	○	○	○
DEVICE - Device batch monitor	○	○	○	○	×	×	○
DEVICE - Entry data monitor	○	○	○	○	×	×	○
DEVICE - Sampling trace	○	○	○	○	×	×	○
PARAMETER - Program setting	×	○	×	×	×	×	○
PARAMETER - Common pointer setting	×	○	×	○	×	×	○
PARAMETER - Multi-project parameter	×	○	×	×	×	×	×
PLC diagnosis	○	○	○	○	×	×	○

(*1) To start while the MTB password is not disabled, the parameter "#6453 R7826-L/bit3" must be set to 1.

(*2) "Password" in this case means a file password.

GX Developer function matrix by project type, enhanced PLC security mode, MTB password status

○ : Available

× : Unavailable

Function	MTB project						E/U project
	No mode		Write protect mode		Read/write protect mode		-
	Password not disabled	Password disabled	Password not disabled	Password disabled	Password not disabled	Password disabled	-
Connection confirmation	○	○	○	○	×	×	○
Read from PLC	○	○	○	○	×	×	○
Write to PLC	○	○	×	×	×	×	○
Verify with PLC	○	○	○	○	×	×	○
Delete PLC data	○	○	×	×	×	×	○
Write the program memory to ROM	○	○	×	×	×	×	○
Monitor	○	○	○	○	×	×	○
Device test	○	○	(*1)	(*1)	×	×	○
Sampling trace	○	○	○	○	×	×	○
Remote operation	○	○	○	○	×	×	○
Password setup(*2)	○	○	×	×	×	×	○
Password delete(*2)	○	○	×	×	×	×	○
Password Cancellation(*2)	○	○	○	○	×	×	○
Format PLC memory	○	○	×	×	×	×	×
PLC diagnostics	○	○	○	○	×	×	○
Write during RUN	○	○	×	×	×	×	○

(*1) Device test is available only for SM and SD devices.

(*2) "Password" in this case means a file password.

GX Works2 function matrix by project type, enhanced PLC security mode, MTB password status

○ : Available

× : Unavailable

Function	MTB project						E/U project
	No mode		Write protect mode		Read/write protect mode		-
	Password not disabled	Password disabled	Password not disabled	Password disabled	Password not disabled	Password disabled	-
Connection confirmation	○	○	○	○	×	×	○
Read from PLC	○	○	○	○	×	×	○
Write to PLC	○	○	×	×	×	×	○
Verify with PLC	○	○	○	○	×	×	○
Delete PLC data	○	○	×	×	×	×	○
Write the program memory to ROM	○	○	×	×	×	×	○
Monitor	○	○	○	○	×	×	○
Watch	○	○	○	○	×	×	○
Current value change	○	○	(*1)	(*1)	×	×	○
Sampling trace	○	○	○	○	×	×	○
Remote operation	○	○	○	○	×	×	○
Password setup(*2)	○	○	×	×	×	×	○
Password delete(*2)	○	○	×	×	×	×	○
Password Cancellation(*2)	○	○	○	○	×	×	○
Format PLC memory	○	○	×	×	×	×	×
Memory size calculation	○	○	○	○	×	×	○
PLC diagnostics	○	○	○	○	×	×	○
Write during RUN	○	○	×	×	×	×	○

(*1) Current values can be changed only for SM and SD devices.

(*2) "Password" in this case means a file password.

9.1.1.7 The Connection Restriction on GX Developer/GX Works2

When the connection restriction on GX Developer/GX Works2 is enabled, connections to the built-in PLC from GX Developer/GX Works2 are prohibited.

Unlike the enhanced PLC security mode, connections from PLC on-board are not prohibited.

Note that it is not possible to connect to the E/U project when the connection restriction on GX Developer/GX Works2 is enabled, even if the E/U mode is enabled.

9.1.1.8 File Password

A file password is a four-digit password of a file in the built-in PLC. A file password is set from GX Developer/GX Works2.

There are two attributes for a file password, read/write protect and write protect. To perform write operations and read operations from PLC on-board or GX Developer/GX Works2, the file password must be disabled.

By setting a file password, you can protect resources such as sequence programs and PLC messages in the built-in PLC.

For details on setting a file password, refer to "5.12 File Password Function".

Relationship with enhanced PLC security mode

[PLC write protect mode]

Although registering and clearing the file password of a file in the built-in PLC from GX Developer/GX Works2 are prohibited, disabling the file password and reading a file are allowed.

[PLC read/write protect mode]

Registering, clearing, and disabling the password of a file in the built-in PLC from GX Developer/GX Works2 are prohibited.

[E/U mode]

Registering, clearing, and disabling the password of a file in the E/U project from GX Developer/GX Works2 are allowed.

Since the enhanced security mode does not apply to the E/U project, end users must set a file password to protect each file.

9.1.2 Relationship with Other Functions

9.1.2.1 Built-in PLC (Built-in Edit Function)

When the enhanced security mode is active, restrictions apply to the input/output between the built-in PLC and PLC on-board. Note that built-in edit function can be started for E/U project irrespective of the enhanced security mode setting and password status.

For details on the PLC on-board function, refer to "6 Explanation of Built-in Editing Function (PLC On-board)".

9.1.2.2 Built-in PLC (Peripheral Development Environment)

When the enhanced security mode is enabled, restrictions apply to the input/output between the built-in PLC and GX Developer.

9.1.2.3 Built-in PLC (Peripheral Development Environment (GX Works2))

When the enhanced security mode is enabled, restrictions apply to the input/output between the built-in PLC and GX Works2.

For details on DX Works2 functions, refer to "5 Peripheral Development Environment (GX Works2)".

9.1.2.4 Protection Setting Screen

The following changes can be made on the protect setting screen.

- Changing operation level
- Changing password for each operation level
- Changing protective level for each data Changing protective level for each data To certainly secure programs which are managed by the MTB, change the default password for MTB to another one.

For details on the protect setting screen, refer to "M800VW/M80VW Series Connection and Setup Manual".

9.1.3 Precautions

Precautions for MTB

- (1) If E/U project is output through E/U customization after the project which stores the E/U open interface, the output timing delays by one scan compared to direct output.
- (2) When end users write a sequence program, PLC STOP applies. Take appropriate measures, such as remote I/O initialization function, to ensure secure machine operation when PLC STOP applies.
- (3) When an E/U project is empty, PLC can run only with MTB projects.
- (4) When an E/U program contains an error, PLC STOP applies, including MTB projects. Take appropriate measures, such as remote I/O initialization function, to ensure secure machine operation when PLC STOP applies.
- (5) In the following cases, the alarm "Z105 end-user parameter error" occurs and PLC STOP applies:
 - PLC end-user parameter values and multi-project parameter values do not match
 - The range determined by the starting device number of E/U open devices and the total number of devices exceeds the upper limit

In such cases, the E/U mode is disabled even if the enhanced security mode is enabled.

- (6) Since end users cannot set the connection restriction on GX Developer/GX Works2, MTB must determine and set the connection restriction on GX Developer/GX Works2 (#11094), taking into account whether the end users use GX Developer/GX Works2.
- (7) Since end users cannot make settings for "Writing during RUN", MTB must set for that (#6455 bit6/bit7), taking into account whether the end users use the function.
- (8) If the end user forgets the file password for an E/U program, it will be impossible to delete the E/U program. To avoid this, create "PROJECTxx.LAD" that stores an empty E/U project ("xx" represents the E/U project number).
- (9) When the parameter "#11018 M password hold" is set to "1", the operation is the same as when the MTB password is input after NC restart even if the MTB password is not actually input. To ensure the security of MTB projects, set #11018 to "0".

Precautions for end users

- (1) PLC STOP is needed when files such as sequence programs are written to the E/U project. Ensure safety before performing a write operation.
- (2) When an E/U project is empty, PLC can run only with MTB projects.
- (3) When an E/U program contains an error, PLC STOP applies, including MTB projects.
- (4) When an E/U program is created as a simple project (with label) on GX Works2, devices automatically assigned may not in line with the limitations on devices. Limit the range of automatic device assignment to the range of E/U open devices.
- (5) If the file password for an E/U program is forgotten, it becomes impossible to change or delete the E/U program.
- (6) If an E/U program is created with following three conditions, the following error occurs when a write operation to the PLC is attempted.

The specified device No. exceeds the permissible range. <ES:010a4031>

- The program is created as a simple project (with label) on GX Works2.
- The item "Clear the device ranges set in the Device/Label Automatic-Assign setting to 0 at time of PLC write after a Rebuild All operation" has been checked.
- Restricted devices for an E/U program are included in the automatic device assignment setting.

When this error is displayed, modify the automatic device assignment setting to an appropriate value, and try a write operation to the PLC again.

9.1.4 Information to be Shared with End Users

When the E/U mode is enabled, provide the information about the built-in PLC and the E/U mode to end users.

The information to be provided to end users are as follows:

- ♦ CNC Manual
- ♦ E/U project No.
- ♦ Limitations on instructions
- ♦ Limitations on devices
- ♦ Limitations on functions
- ♦ Maximum number of steps for E/U project
- ♦ Common devices for E/U open interface and the meaning of the signals to be assigned
- ♦ Example of E/U program
- ♦ Precautions

■ CNC Manual

End users need to know the specifications of the built-in PLC in M800V/M80V series NCs to create sequence programs. Provide "PLC Development Manual" (this manual) and "PLC Programming Manual".

■ E/U project No.

Inform end users which project is the E/U project among the multi-projects.

■ Limitations on instructions

The following dedicated instructions cannot be used in E/U programs
S.ROT, S.ATC, G(P).RIRD, G(P).RIWT, Z(P).REMF, Z(P).REMTO
Inform end users that these instructions are unavailable.

9 Appendix 3: PLC Function

9.1 Enhanced PLC Security Mode

■ Limitations on devices

There are limitations on the devices that can be input/output to the E/U project.

Apart from those limitations posed by the specifications of the NC, certain limitations on devices can be set by the MTB. Inform end users of the limitations on devices after the MTB configured the PLC end-user parameters and multi-project parameters.

For example, when the number of devices for PLC end-user parameters and multi-project parameters are configured as “PLC end-user parameter setting” and “Device setting” indicated as follows,, the limitations on devices to be provided to end users are described in the next table.

[PLC end-user parameter setting]

#	Item		Details	Setting value
11762 (PR)	E/U Project No.	E/U project number	Specify the project number to be used as the E/U project by the end user.	3
11763 (PR)	E/U Y Dev No.	Initial number of Y device for E/U	Specify the starting device number of the Y devices customizable by the end user.	0
11764 (PR)	E/U Y Dev Size	Quantity of Y devices for E/U	Specify the number of Y devices customizable by the end user.	100
11765 (PR)	E/U M Dev No.	Initial number of M device for E/U	Specify the starting device number of the project-common M devices customizable by the end user.	1024
11766 (PR)	E/U M Dev Size	Quantity of M devices for E/U	Specify the number of project-common M devices customizable by the end user.	1024
11767 (PR)	E/U D Dev No.	Initial number of D device for E/U	Specify the starting device number of the project-common D devices customizable by the end user.	128
11768 (PR)	E/U D Dev Size	Quantity of D devices for E/U	Specify the number of project-common D devices customizable by the end user.	384

[Device setting]

	01	02	03	COMMON	TOTAL	REMAIN
M	15360	15360	15360	15360	61440	0
L	256	256	256	0	768	256
B	14336	14336	14336	0	43008	14336
F	0	0	0	2048	2048	0
SB	256	256	256	0	768	256
V	128	128	128	0	384	128
S	0	0	0	0	0	0
T	512	512	512	0	1536	512
ST	32	32	32	0	96	32
C	128	128	128	0	384	128
D	1024	1024	1024	1024	4096	0
W	3072	3072	3072	0	9216	3072
SW	256	256	256	0	768	256
TOTAL	10.0K	10.0K	10.0K			

Category	Device	Limitations on devices
Common device	X, Y, F, R, ZR	All devices can be input. Y0 to YFF can be output.
Independent device (variable)	L, SB, B, V, SW, T, ST, C, W	All devices can be input. All devices can be output.
Independent device (fixed)	SM, SD, Z	All devices can be input. All devices can be output.
Independent device (fixed)	N, P	All devices can be input. None of devices can be output
Common/independent device	M, D	All devices can be input. The following devices can be output: M1024 to M2047, M15360 to M31719, D128 to D511, D1024 to D2047

9 Appendix 3: PLC Function

9.1 Enhanced PLC Security Mode

■ Limitations on functions

Inform end users of the limitations on functions for the E/U project.

For example, add a phrase like this to the manual.

Connecting to a project other than the E/U project is not possible. Formatting from PLC on-board and GX Developer/GX Works2 is not possible. It is also impossible to modify multi-project parameters from PLC on-board.

■ Maximum number of steps for E/U project

Inform end users of the limit for the total number of steps of an E/U program that can be stored in the E/U project.

The maximum number of steps depends on the project ratio of multi-project parameter.

For example, when the NC is M80VW, E/U project No is 3, and the project ratio is like the following figure, the maximum number of steps is calculated to be "13107" by the formula below.

$$64K \text{ (steps)} \times 0.20 = 13107.2 \text{ (steps)}$$

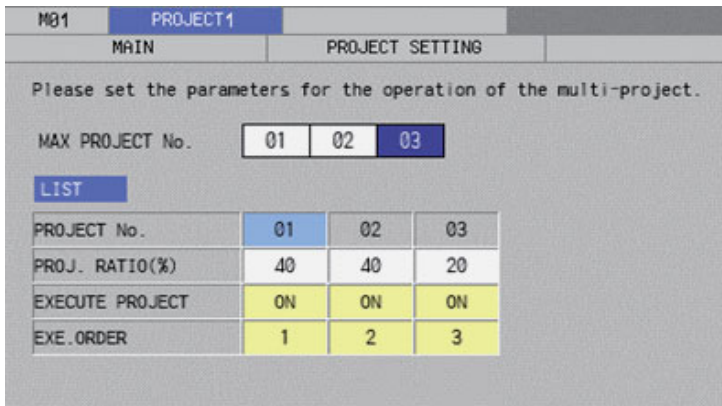

■ Common devices for E/U open interface and the meaning of the signals to be assigned

Inform end users of the input side devices (M, D devices), output side devices (X, Y, R, ZR devices), and the signals assigned to output side devices of the E/U open interface created by MTB program.

For example, if M1024 to M2047 and D128 to D511 are set as E/U open devices and the E/U open interface is set like the following figure, provide end users with information in the table below.

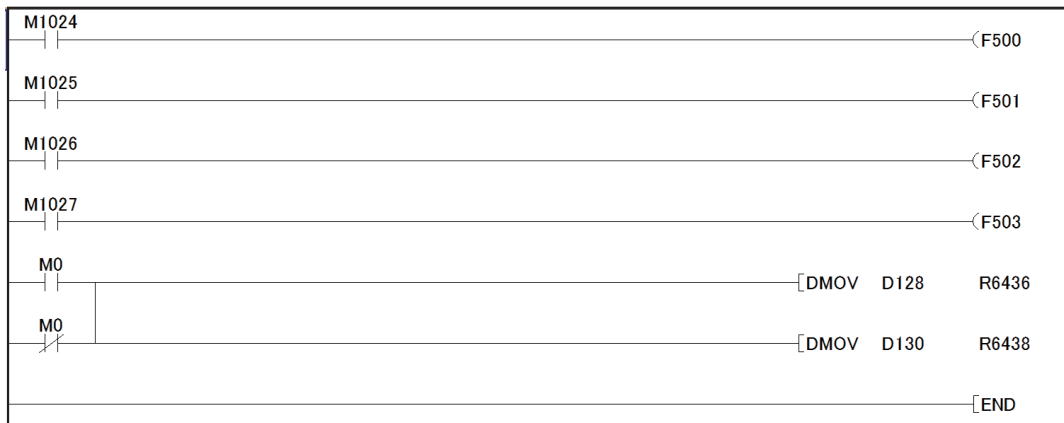

Signal name	Input to PLC	Output to NC
PLC alarm	F500	M1024
PLC alarm	F501	M1025
PLC alarm	F502	M1026
PLC alarm	F503	M1027
User macro input #1033 (PLC -> NC) (low-order)	R6436	D128
User macro input #1033 (PLC -> NC) (high-order)	R6437	D129
User macro input #1034 (PLC -> NC) (low-order)	R6438	D130
User macro input #1034 (PLC -> NC) (high-order)	R6439	D131

■ Example of E/U program

Provide end users with an example of E/U program for E/U project setting.

For example, when an E/U open interface is created like the example in "Common devices for E/U open interface and the meaning of the signals to be assigned", the E/U program that outputs the value of "User macro output #1132 (NC -> PLC)" (R6372, R6373) to "User macro input #1033 (PLC -> NC)" is as shown below.

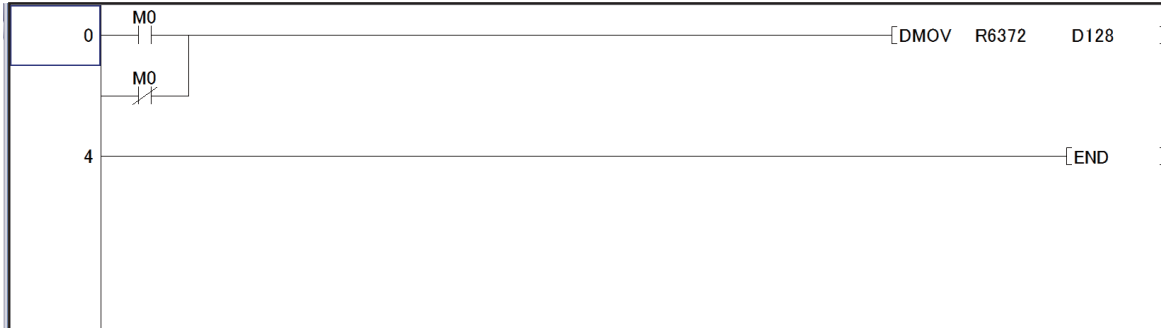

■ Precautions

Inform end users of the precaution described on "Precautions for End Users" in "9.1.3 Precautions" so that they can develop PLC safely.

Revision History

Date of revision	Manual No.	Revision details
Mar. 2021	IB(NA)1501614-A	The first edition was created.
Jul. 2021	IB(NA)1501614-B	<p>Contents were revised to correspond to Mitsubishi Electric CNC M800VS/M80V Series. Contents were revised to correspond to Mitsubishi Electric CNC M800V/M80V Series software version A1.</p> <p>The following chapters were added.</p> <ul style="list-style-type: none"> ♦ 6.6.2.1 The Number of Ladder Files and PLC Message Files Available on One Project <p>The following chapters were changed.</p> <ul style="list-style-type: none"> ♦ 2.1 System Configuration ♦ 5.8.3.3 File Name Rule ♦ 6.1.1 List of Project ♦ 6.5.1 Screen Display Language ♦ 6.5.2 Language for Device Comments, Statements, Notes, and Machine Names ♦ 6.9.1 Compatible Types ♦ 6.11.1.2 Cases in which Sequence Programs are Stored ♦ 6.12.1.1 Cases in which Sequence Programs are Stored ♦ 6.13.3.6 Opening PLC Data ♦ 6.13.10.2 Screen Display Menus ♦ 6.14.1.2 Enabled/Disabled State of Menu Keys ♦ 6.15.3.2 Screen Display Items ♦ 6.15.6.1 Outline ♦ 6.15.7.1 Outline ♦ 6.15.8.1 Outline ♦ 6.15.9 Split Screen <p>Other mistakes were corrected.</p>

Global Service Network

AMERICA

MITSUBISHI ELECTRIC AUTOMATION INC. (AMERICA FA CENTER)

Central Region Service Center (Chicago)
500 CORPORATE WOODS PARKWAY, VERNON HILLS, ILLINOIS 60061, U.S.A.
TEL: +1-847-478-2500 / FAX: +1-847-478-2650
Minneapolis, MN Service Satellite
Detroit, MI Service Satellite
Grand Rapids, MI Service Satellite
Lima, OH Service Satellite
Cleveland, OH Service Satellite
Indianapolis, IN Service Satellite
St. Louis, MO Service Satellite

South/East Region Service Center (Georgia)
1845 SATELLITE BOULEVARD STE. 450, DULUTH, GEORGIA 30097, U.S.A.
TEL: +1-678-258-4529 / FAX: +1-678-258-4519

Charleston, SC Service Satellite
Charlotte, NC Service Satellite
Raleigh, NC Service Satellite
Dallas, TX Service Satellite
Houston, TX Service Satellite
Hartford, CT Service Satellite
Knoxville, TN Service Satellite
Nashville, TN Service Satellite
Baltimore, MD Service Satellite
Pittsburg, PA Service Satellite
Newark, NJ Service Satellite
Syracuse, NY Service Satellite
Ft. Lauderdale, FL Service Satellite
Lafayette, LA Service Satellite

Western Region Service Center (California)
5900-B KATELLA AVE. - 5900-A KATELLA AVE, CYPRESS, CALIFORNIA 90630, U.S.A.
TEL: +1-714-699-2625 / FAX: +1-847-478-2650

San Francisco, CA Service Satellite
Seattle, WA Service Satellite
Denver, CO Service Satellite

Canada Region Service Center (Tronto)
4299 14TH AVENUE MARKHAM, ONTARIO L3R OJ2, CANADA
TEL: +1-905-754-3805 / FAX: +1-905-475-7935
Edmonton, AB Service Satellite
Montreal, QC Service Satellite

Mexico Region Service Center (Querétaro)
Parque Tecnológico Innovación Querétaro, Lateral Carretera Estatal 431, Km 2+200, Lote 91 Modulos 1 y 2
Hacienda la Machorra, CP 76246, El Marqués, Querétaro, México
TEL: +52-442-153 6050
Monterrey, NL Service Satellite
Mexico City, DF Service Satellite
Aguascalientes, AGS, Service Satellite

BRAZIL

MITSUBISHI ELECTRIC DO BRASIL COMÉRCIO E SERVIÇOS LTDA.

Votorantim Office
AV. GISELE CONSTANTINO,1578, PARQUE BELA VISTA, VOTORANTIM-SP, BRAZIL CEP:18.110-650
TEL: +55-15-3023-9000
Blumenau Santa Catarina office
MAQSERVICE – Canoas, RS Service Satellite

EUROPE

MITSUBISHI ELECTRIC EUROPE B.V.

European Service Headquarters (Dusseldorf, GERMANY)
Mitsubishi-Electric-Platz 1 40882 RATINGEN, GERMANY
TEL: +49-2102-486-5000 / FAX: +49-2102-486-5910

South Germany Service Center (Stuttgart)
SCHELMENWASENSTRASSE 16-20, 70567 STUTTGART, GERMANY
TEL: + 49-711-770598-123 / FAX: +49-711-770598-141

France Service Center (Paris)
25, BOULEVARD DES BOUVETS, 92741 NANTERRE CEDEX FRANCE
TEL: +33-1-41-02-83-13 / FAX: +33-1-49-01-07-25

France Service Satellite (Lyon)
120, ALLEE JACQUES MONOD 69800 SAINT PRIEST FRANCE
TEL: +33-1-41-02-83-13 / FAX: +33-1-49-01-07-25

Italy Service Center (Milan)
CENTRO DIR. COLLEONI, PALAZZO SIRIO, VIALE COLLEONI 7, 20864 AGRATE BRIANZA (MB) ITALY
TEL: +39-039-6053-342 / FAX: +39-039-6053-206

Italy Service Satellite (Padova)
VIA G. SAVELLI, 24 - 35129 PADOVA, ITALY
TEL: +39-039-6053-342 / FAX: +39-039-6053-206

U.K. Service Center
TRAVELLERS LANE, HATFIELD, HERTFORDSHIRE, AL10 8XB, U.K.
TEL: +49-2102-486-5000 / FAX: +49-2102-486-5910

Spain Service Center
CTRA. RUBI, 76-80 8174 SAINT CUGAT DEL VALLES, BARCELONA SPAIN
TEL: +34-935-65-2236 / FAX: +34-935-89-1579

Poland Service Center
UL.KRAKOWSKA 50, 32-083 BALICE, POLAND
TEL: +48-12-347-6500 / FAX: +48-12-630-4701

Hungary Service Center
MADARASZ IRODAPARK, MADARASZ VIKTOR UT 47-49, 1138 BUDAPEST, HUNGARY
TEL: +48-12-347-6500 / FAX: +48-12-630-4701

Turkey Service Center
MITSUBISHI ELECTRIC TURKEY A.Ş
SERIFALI MAHALLESİ NUTUK SOKAK. NO.41 34775
UMRANIYE, ISTANBUL, TURKEY
TEL: +90-216-969-2500 / FAX: +90-216-526-3995

Czech Republic Service Center
AutoCont Control Systems s.r.o (Service Partner)
KAFKOVA 1853/3, 702 00 OSTRAVA 2, CZECH REPUBLIC
TEL: +420-59-5691-185 / FAX: +420-59-5691-199

Russia Service Center
MITSUBISHI ELECTRIC RUSSIA LLC
LETNIKOVSKAYA STREET 2, BLD.1, 5TH 115114 MOSCOW, RUSSIA
TEL: +7-495-721-2070 / FAX: +7-495-721-2071

Sweden Service Center
HAMMARBACKEN 14, P.O.BOX 750 SE-19127, SOLLENTUNA, SWEDEN
TEL: +46-8-6251000 / FAX: +46-8-966877

Bulgaria Service Center
AKHNATON Ltd. (Service Partner)
4 ANDREJ L.JAPCHEV BLVD. POB 21, BG-1756 SOFIA, BULGARIA
TEL: +359-2-8176009 / FAX: +359-2-9744061

Ukraine Service Center (Kiev)
CSC Automation Ltd. (Service Partner)
4 B, YEVHENA SVERSTYUKA STR., 02002 KIEV, UKRAINE
TEL: +380-44-494-3344 / FAX: +380-44-494-3366

Belarus Service Center
TECHNIKON Ltd. (Service Partner)
NEZAVISIMOSTI PR.177, 220125 MINSK, BELARUS
TEL: +375-17-393-1177 / FAX: +375-17-393-0081

South Africa Service Center
Adroit Technologies (Service Partner)
20 Waterford Office Park, Waterford Drive, cnr of Witkoppen Road,
Fourways Johannesburg South Africa
TEL: +27-11-658-8100 / FAX: +27-11- 658-8101

ASEAN**MITSUBISHI ELECTRIC ASIA PTE. LTD. (ASEAN FA CENTER)**

Singapore Service Center
307 ALEXANDRA ROAD #05-01/02 MITSUBISHI ELECTRIC BUILDING SINGAPORE 159943
TEL: +65-6473-2308 / FAX: +65-6476-7439

PHILIPPINE**MELCO FACTORY AUTOMATION PHILIPPINES INC.**

Head Office
128 LOPEZ RIZAL STREET, BRGY., HIGHWAY HILLS, MANDALUYONG CITY, MM PHILIPPINES 1550
TEL: +63-2-8256-8042 / FAX: +632-8637-2294

Philippines Service Center
KM.23 WEST SERVICE ROAD SSH, CUPANG ,MUNTINLUPA CITY PHILIPPINES
TEL: +63-2-8807-0420 / FAX: +63-2-8842-5202

VIETNAM**MITSUBISHI ELECTRIC VIETNAM CO.,LTD.**

Vietnam Ho Chi Minh Service Center
11TH & 12TH FLOOR, VIETTEL TOWER B, 285 CACH MANG THANG 8 STREET, WARD 12, DISTRICT 10, HO CHI MINH CITY, VIETNAM
TEL: +84-28-3910 5945 / FAX: +84-28-3910 5947

Vietnam Hanoi Service Center
24TH FLOOR, HANDICO TOWER, PHAM HUNG ROAD, ME TRI HA, ME TRI WARD, NAM TU LIEM DISTRICT, HA NOI CITY, VIETNAM
TEL: +84-24-3937-8075 / FAX: +84-24-3937-8076

INDONESIA**PT. MITSUBISHI ELECTRIC INDONESIA**

Indonesia Service Center (Cikarang)
JL. KENARI RAYA BLOK G2-07A, DELTA SILICON 5, LIPPO CIKARANG - BEKASI 17550, INDONESIA
TEL: +62-21-2961-7797 / FAX: +62-21-2961-7794

MALAYSIA**MITSUBISHI ELECTRIC SALES MALAYSIA SDN. BHD.**

Malaysia Service Center (Kuala Lumpur Service Center)
LOT 11, JALAN 219, P.O BOX 1036, 46860 PETALING JAYA, SELANGOR DARUL EHSAN. MALAYSIA
TEL: +60-3-7960-2628 / FAX: +60-3-7960-2629
Johor Bahru Service Satellite

THAILAND**MITSUBISHI ELECTRIC FACTORY AUTOMATION (THAILAND) CO.,LTD.**

Thailand Service Center (Bangkok)
101, TRUE DIGITAL PARK OFFICE, 5TH FLOOR, SUKHUMVIT ROAD, BANGCHAK, PHRAKHANONG, BANGKOK, 10260 THAILAND
TEL: +66-2-092-8600 / FAX: +66-2-043-1231-33
Bowin Service Center (Chonburi)
Korat Service Center

INDIA**MITSUBISHI ELECTRIC INDIA PVT., LTD.**

CNC Technical Center (Bangalore)
PLOT NO. 56, 4TH MAIN ROAD, PEENYA PHASE 3, PEENYA INDUSTRIAL AREA, BANGALORE 560058, KARNATAKA, INDIA
TEL : +91-80-4655-2121 / FAX : +91-80-4655-2147
Chennai Service Satellite
Coimbatore Service Satellite
Hyderabad Service Satellite

North India Service Center (Gurgaon)
PLOT 517, GROUND FLOOR, UDYOG VIHAR PHASE-III, GURUGRAM 122008, HARYANA, INDIA
TEL : +91-124-463-0300 / FAX : +91-124-463-0399

Ludhiana Service Satellite
Panth Nagar Service Satellite
Delhi Service Satellite
Jamshedpur Service Satellite
Manesar Service Satellite

West India Service Center (Pune)
ICC-Devi GAURAV TECHNOLOGY PARK, UNIT NO.402, FOURTH FLOOR, NORTH WING, SURVEY NUMBER 191-192 (P), NEXT to INDIAN CARD CLOTHING COMPANY Ltd, OPP. VALLABH NAGAR, PIMPRI, PUNE- 411 018, MAHARASHTRA, INDIA
TEL : +91-20-6819 2274 / FAX : +91-20-4624 2100
Kolhapur Service Satellite
Aurangabad Service Satellite
Mumbai Service Satellite

West India Service Center (Ahmedabad)
204-209, 2ND FLOOR, 31FIVE, CORPORATE ROAD PRAHLADNAGAR, AHMEDABAD -380015, GUJARAT, INDIA
TEL : + 91-79-6777 7888
Rajkot Service Satellite

CHINA**MITSUBISHI ELECTRIC AUTOMATION (CHINA) LTD. (CHINA FA CENTER)**

CNC Call Center
TEL: +86-400-921-5130

Shanghai Service Center
1-3,5-10,18-23/F, NO.1386 HONG QIAO ROAD, CHANG NING QU, SHANGHAI 200336, CHINA
TEL: +86-21-2322-3030 / FAX: +86-21-2322-3000*8422

Qingdao Service Center
Suzhou Service Center
Wuhan Service Center
Ningbo Service Center
Hefei Service Center
Beijing Service Center
Tianjin Service Center
Xian Service Center
Dalian Service Center
Chengdu Service Center

Shenzhen Service Center
LEVEL8, GALAXY WORLD TOWER B, 1 YABAO ROAD, LONGGANG DISTRICT, SHENZHEN 518129, CHINA
TEL: +86-755-2399-8272 / FAX: +86-755-8229-3686

Dongguan Service Center
Xiamen Service Center

KOREA**MITSUBISHI ELECTRIC AUTOMATION KOREA CO., LTD. (KOREA FA CENTER)**

Korea Service Center
8F GANGSEO HANGANG XI-TOWER A, 401 YANGCHEON-RO, GANGSEO-GU, SEOUL 07528 KOREA
TEL: +82-2-3660-9609 / FAX: +82-2-3664-8668
Korea Daegu Service Satellite

TAIWAN**MITSUBISHI ELECTRIC TAIWAN CO., LTD. (TAIWAN FA CENTER)**

Taiwan Taichung Service Center
NO.8-1, INDUSTRIAL 16TH RD., TAICHUNG INDUSTRIAL PARK, SITUN DIST., TAICHUNG CITY 40768, TAIWAN
TEL: +886-4-2359-0688 / FAX: +886-4-2359-0689

Taiwan Taipei Service Center
10F, NO.88, SEC.6, CHUNG-SHAN N. RD., SHI LIN DIST., TAIPEI CITY 11155, TAIWAN
TEL: +886-2-2833-5430 / FAX: +886-2-2833-5433

Taiwan Tainan Service Center
11F-1., NO.30, ZHONGZHENG S. ROAD, YONGKANG DISTRICT, TAINAN CITY 71067, TAIWAN
TEL: +886-6-252-5030 / FAX: +886-6-252-5031

OCEANIA**MITSUBISHI ELECTRIC AUSTRALIA PTY. LTD.**

Oceania Service Center
348 VICTORIA ROAD, RYDALMERE, N.S.W. 2116 AUSTRALIA
TEL: +61-2-9684-7269/ FAX: +61-2-9684-7245

Notice

Every effort has been made to keep up with software and hardware revisions in the contents described in this manual. However, please understand that in some unavoidable cases simultaneous revision is not possible. Please contact your Mitsubishi Electric dealer with any questions or comments regarding the use of this product.

Duplication Prohibited

This manual may not be reproduced in any form, in part or in whole, without written permission from Mitsubishi Electric Corporation.

COPYRIGHT 2021 MITSUBISHI ELECTRIC CORPORATION ALL RIGHTS RESERVED

MITSUBISHI ELECTRIC CORPORATION

HEAD OFFICE : TOKYO BLDG.,2-7-3 MARUNOUCHI,CHIYODA-KU,TOKYO 100-8310,JAPAN

MODEL	M800V/M80V Series
MODEL CODE	100-745
Manual No.	IB-1501614